

Building connections that last™



Gruvlok® Mechanical Piping

Submittal Catalog February 2023



Anvil and Smith-Cooper are now ASC Engineered Solutions™

In 2019, Anvil International merged with Smith-Cooper International. The result was a complementary pair of industry leaders working side by side to provide precision-engineered pipes, valves, fittings and supports, along with related services.

For over 150 years, we have worked to build a strong, vibrant tradition of making connections - pipe to pipe and people to people. We've always been dedicated to building connections that last. As ASC Engineered Solutions, we are ready to make those connections stronger than ever by focusing as much on how we serve our customers as on the products we provide. This is what makes ASC stand out.

We're in the solutions business. That means we go beyond a product portfolio of unmatched quality and breadth. A solution involved much more than products: it takes expertise, reliable availability and dependable partnership. Providing engineered solutions means solving customer challenges - and that's why we exist.

One company.

One focus.

Your success.

Gruvlok®

Mechanical Piping Products

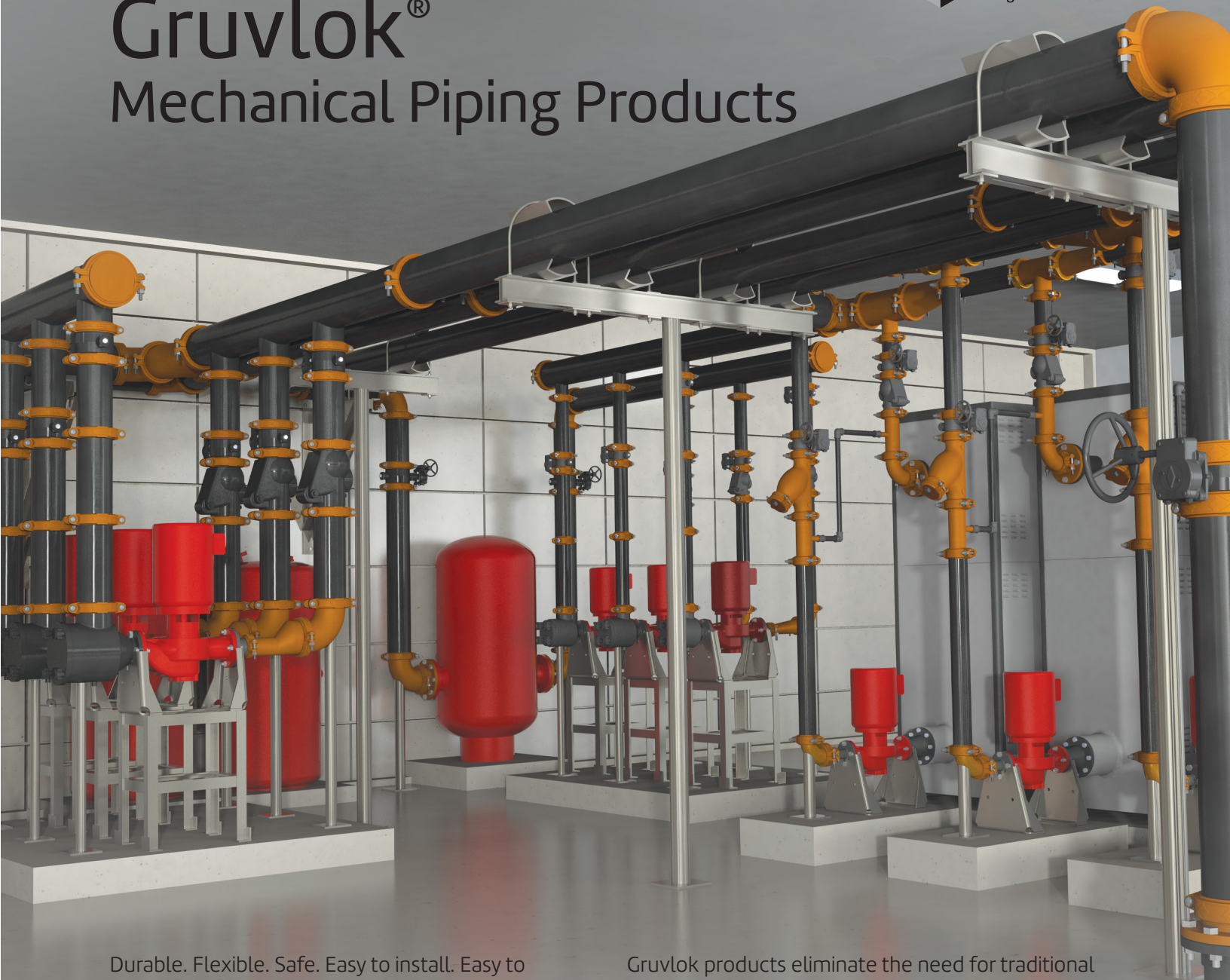

Durable. Flexible. Safe. Easy to install. Easy to maintain. That's ASC's Gruvlok product line. Gruvlok gives your building the toughest, simplest, and most adaptable piping system possible.

Through a combination of roll-grooving and two-bolt coupling design, this innovative product line joins piping and other components into a single rugged yet flexible system. This makes Gruvlok products ideal for a variety of applications — particularly in tight spaces such as subfloors, UFAD systems, crawlspaces, trenches, and tunnels.

Gruvlok products eliminate the need for traditional expansion joints, allowing your system to expand and contract with your needs. With a Gruvlok union at every joint, you have the freedom to make on-site tweaks without altering the overall design of your system.

Maintenance is as simple and flexible as installation. Every component in a Gruvlok system is easily replaceable and easily accessed, so that you can make repairs without resorting to a total shut-down.

Table of Contents

Introduction

Gruvlok® Pictorial Parts Index	6-13
Agency Approvals.....	14
Gruvlok® – The Engineered Coupling.....	15
The Gruvlok® Piping Method	16
Gruvlok® Couplings For Grooved-End Pipe	17
Coupling Data Chart Notes	18

Couplings For Grooved-End Pipe

Fig. 7401 RigidLOK® Coupling	19-20
Fig. 74 SlideLOK® Ready For Installation Coupling.....	24-25
Fig. 7401-2 RigidLOK® Coupling	22-23
Fig. 70 SlideFLEX® Flexible Coupling.....	26-27
Fig. 7001 Flexible Coupling.....	28-30
Fig. 7001-2 Flexible Coupling.....	31-32
Fig. 7011 Standard Coupling.....	33-34
Fig. 7022 Weld Ring Gruv-Ring Coupling	35-38
Fig. 7000 Lightweight Flexible Coupling.....	39-41
Fig. 7400 Rigidlite® Coupling.....	42-43
Fig. 7003 Hingelok® Coupling	44-45
Fig. 7010 Reducing Coupling	46-47
Fig. 7788 Gruvlok® Flange Adapter	48-49
Fig. 7012 Gruvlok® Flange	50-52
Fig. 7013 Gruvlok® Flange	53-55
Flanged Seal Rings	56-57
Fig. 7240 Expansion Joint	58-60

Branch Outlets

Fig. 7042 Outlet Coupling	61-63
Fig. 7045 Clamp-T, FPT Branch	64-67
Fig. 7046 Clamp-T, Grooved Branch	68-70
Fig. 7047, Fig. 7048 & Fig. 7049 Clamp-T, Cross.....	71
Fig. 7043 Branch Outlet	72-73

Fittings For Grooved-End Pipe

Technical Data	74
Fig. 7050 90° Elbow.....	74-77
Fig. 7051 45° Elbow.....	74-77
Fig. 7052 22½° Elbow.....	74-77
Fig. 7053 11¼° Elbow.....	78-81
Fig. 7050LR 90° Long Radius Elbow.....	78-81
Fig. 7051LR 45° Long Radius Elbow.....	78-81
Fig. 7060 Tee.....	82-84
Fig. 7061 Reducing Tee Standard	85-88
Fig. 7063 Tee with Threaded Branch.....	89-91
Fig. 7064 Reducing Tee with Threaded Branch..	92-95
Fig. 7076 GR x Thd Concentric Reducer	82-84
Fig. 7073 & Fig. 7097 Eccentric Reducer.....	96-98
Fig. 7077, Fig. 7078 &	
Fig. 7079 Swaged Nipples	99-101

Fig. 7072 GR x GR Concentric Reducer	102-104
Fig. 7069 45° Lateral.....	105-108
Fig. 7070 45° Reducing Lateral	105-108
Fig. 7066 Tee Wye.....	109-112
Fig. 7067 Reducing Tee Wye.....	109-112
Fig. 7071 True Wye.....	109-112
Fig. 7087 GR x FPT Female Thread Adapter	113-115
Fig. 7055 GR x MPT 90° Adapter Elbow	113-115
Fig. 7056 GR x MPT 45° Adapter Elbow	113-115
Fig. 7050RF Grooved x 150# Flanged (G x F)	113-115
Fig. 7072GF GR x Flange Concentric Reducer	116-119
Fig. 7084 Groove x Class 150 Flange Nipple	120-122
Fig. 7085 Groove x Class 300 Flange Nipple	120-122
Fig. 7074 Cap	123-125
Fig. 7075 Bull Plug.....	123-125
Fig. 7068 Cross	123-125
Fig. 7086 GR x Hose Nipple	126-128
Fig. 7080 GR x GR Adapter Nipple.....	126-128
Fig. 7081 GR x MPT Adapter Nipple.....	126-128
Fig. 7082 GR x Bev Adapter Nipple.....	126-128
Fig. 7062 Bullhead Tee Specialty Tee (GR x GR x FPT).....	129-131
Fig. 7065 Standpipe Tee (GR x GR x FPT).....	129-131
Fig. 7050DR 90° Drain Elbow	129-131
Fig. 7450 90° Short Pattern Elbow	132-134
Fig. 7460 Short Pattern Tee	135-136

Fig. 7050-3D Long Radius Elbows

Fig. 7050-3D 90° Elbow.....	137-140
Fig. 7057-3D 60° Elbow.....	137-140
Fig. 7051-3D 45° Elbow.....	137-140
Fig. 7058-3D 30° Elbow.....	137-140
Fig. 7052-3D 22½° Elbow	137-140
Fig. 7053-3D 11¼° Elbow	137-140

Fig. 7050-5D Long Radius Elbows

Fig. 7050-5D 90° Elbow.....	141-144
Fig. 7057-5D 60° Elbow.....	141-143
Fig. 7051-5D 45° Elbow.....	141-144
Fig. 7058-5D 30° Elbow.....	141-144
Fig. 7052-5D 22½° Elbow	141-144
Fig. 7053-5D 11¼° Elbow	141-144

Fig. 7050-6D Long Radius Elbows

Fig. 7050-6D 90° Elbow.....	145-148
Fig. 7057-6D 60° Elbow.....	145-148
Fig. 7051-6D 45° Elbow.....	145-148

Fig. 7058-6D 30° Elbow.....	145-148
Fig. 7052-6D 22½° Elbow	145-148
Fig. 7053-6D 11¼° Elbow	145-148

Valves & Accessories

Series 7700 Butterfly Valve.....	149-152
Series 8000GR Butterfly Valve	153-156
Fig. 70G Butterfly Valve	157-158
Fig. 1700G Butterfly Valve	159-161
Model B333 Large Diameter Butterfly Valve With Gear Operator	162-164
Series 8100 Low Profile Butterfly Valve.....	165-166
Model B8200L PVC Butterfly Valve	167-168
Series 7500 Ball Valve	169-172
Model BV835 Grooved End Ball Valve With Lever Handle and Gear Operator	173-174
Fig. 90G Check Valve.....	175-176
Fig. 400G Grooved-End Silent Check Valve....	177-178
Series 7800 Check Valve	179-181
Fig. CV890 Dual Disc Check Valve	182-183
ABV-9900V Series – Straight DZR Brass Automatic Balancing Valve.....	184-187
MBV-9510 Series – Fixed Orifice Double Regulating Valve.....	188-191
MBV-9510AB Series – Fixed Orifice Double Regulating Low Lead Valve.....	192-195
CSV-9520AB Series – DZR Brass On/Off Terminal Low Lead Balancing Valves.....	196-200
Fig. M2W Standard Coil Hook-up Kit Configuration.....	201-202
Fig. Anvil 92ST – DZR Brass Ball Valve with Strainer	203-204
Fig. Anvil 92BPC – DZR Brass Ball Valve with Bypass.....	205-206
Fig. Anvil 99IBV – Ball Valve with Nut for 9900V Series Valves.....	207-208
Fig. Anvil 92UN – DZR Brass Union Body with AirVent and Test Point	209-210
Fig. Anvil 92HS – Stainless Steel Braided Hose.....	211-212
Series GBV-A, GBV-F & GBV-G Balancing Valves	213-216
Model CB800 Circuit Balancing Valves - Grooved Ends.....	217-226
Model CB800 Circuit Balancing Valves - Flanged Ends.....	217-226
Model FTV-S & FTV-A Tri-Service Valves	227-228
Fig. 7260 Tee Strainer.....	233-234
Model 758G Grooved-End "Wye" Strainer	231-232
Model 768G Grooved-End "Wye" Strainer	233-234
Fig. 7250 Suction Diffuser	235-237
Fig. S810 Suction Diffuse	238-242
Model GAV-15 Automatic Air Vent	243-244
Model GAV-30 Automatic Air Vent	245-246

Table of Contents

AnvilFlex® Flex Connectors

Technical Data	247
Fig. AF-21-GG Grooved Ends Connector	247-248
Fig. AF-21-GF GR x Class 150 Flanged Flex Connector	249-250
Fig. AF-21-FF Class 150 Flanged x Class 150 Flanged Flex Connector	251-252
Fig. AF-21-RFF Class 150 Flanged x Class 150 Flanged Reducing Flex Connector	253-254
Fig. AF-21-RGF GR x Class 150 Flanged Reducing Flex Connector	255-256

High Pressure Systems

High Pressure Couplings

Fig. 7004 Coupling	257-258
Fig. 7004EG High Pressure Coupling	259-260
Fig. 770 Rigid Coupling	261-262
Fig. 7377 Double Groove Coupling	263-265

High Pressure Fittings

Fig. 7050EG High Pressure 90° LR Elbow	266-267
Fig. 7051EG High Pressure 45° LR Elbow	266-267
Fig. 7060EG High Pressure Tee	268-269
Fig. 7662EG High Pressure Header Tee	268-269
Fig. 7068EG High Pressure Cross	268-269

Gruvlok® CTS Copper System

CTS Copper System Couplings

Technical Data	270
Fig. 64 CTS SlideLOK Rigid Coupling	271-272
Fig. 617 Transition Coupling for Joining IPS to Copper Tubing Systems	273-274

CTS Copper System Fittings

Fig. 6084 Flange Adapter	275
Fig. 610 90° CTS Elbow	276, 277
Fig. 601 45° CTS Elbow	276, 277
Fig. 619 CTS Tee	276, 278
Fig. 660 CTS Cap	276, 278
Fig. 621 (GR x GR x GR) CTS Reducing Tee	276, 279
Fig. 618 (GR x GR x Cup) CTS Reducing Tee	276, 279
Fig. 650 (GR x GR) CTS Concentric Reducer	276, 280
Fig. 652 (GR x Cup) CTS Concentric Reducer	276, 280
CTS Copper System Valve Series 6700 & CTS Copper Butterfly Valve	281-283

Di-Electric Pipe Nipples

Fig. 7088 - Thread x Groove	284-285
Fig. 7089 - Groove x Groove	284-285
Fig. 7090 - Thread x Thread	284-285
Fig. 7091 - CTS Groove by IPS Groove	286-287

Gruvlok® Plain End Fittings

Plain-End Couplings

Fig. 7005 Roughneck® Coupling	288-289
-------------------------------------	---------

Plain-End Fittings

Technical Data	290
Fig. 7050P 90° Elbow	290-291
Fig. 7051P 45° Elbow	290-291
Fig. 7060P Tee	290-291
Fig. 7068P Cross	292-293
Fig. 7061P Reducing Tee	294-295
Fig. 7069P 45° Lateral	292-293
Fig. 7071P 90° True Wye	292-293
Fig. 7050LRP 90° LR Elbow	296-297
Fig. 7051LRP 45° LR Elbow	296-297
Fig. 7084P & Fig. 7085P (Plain-End x Class 150 or 300) Flange Nipple	294-295
Fig. 7075P Bull Plug	296-297

Adapter Nipples

Fig. 7080P Plain x Grooved	298-299
Fig. 7081P Plain x Thread	298-299
Fig. 7082P Plain x Bevel	298-299
Fig. 7077P Swaged Nipple	300-301

HDPE Couplings

Fig. 7305 HDPE Coupling	302-304
Fig. 7307 HDPE Transition Coupling	305-306
Fig. 7312 HDPE Flange Adapter	307-309

Sock-It® Piping Method Fittings

Technical Data	310
Fig. 7100 90° Elbow	310-311
Fig. 7101 90° Reducing Elbow	312-313
Fig. 7103 Straight Tee	314-315
Fig. 7107 Coupling	316-317
Fig. 7105 Reducing Outlet Tee	318-319
Fig. 7106 Reducing Tee	320-321

Stainless Steel Method

Stainless Steel Couplings

Fig. 7001SS Flexible Coupling	322-323
Fig. 7401SS Rigid Coupling	324-325

Stainless Steel Fittings

Technical Data	326
Fig. 7050SS 90° Stainless Steel Elbow	326, 327
Fig. 7061SS Stainless Steel Reducing Tee ...	326, 327
Fig. 7051SS 45° Stainless Steel Elbow	326, 328
Fig. 7060SS Stainless Steel Tee	326, 327
Fig. 7074SS Stainless Steel Caps	326, 328
Fig. 7788SS Cast SST Flange Adapter	326, 330

Fig. 7084SS Stainless Steel Flange Adapter (Groove x Class 150)	326, 330
Fig. 7072SS Stainless Steel	326, 331
Fig. 7073SS Stainless Steel Eccentric Reducer	326, 332

Stainless Steel Valves

Model B480 Grooved End Stainless Steel Butterfly Valve with Lever Handle	333-336
Model BV435 Grooved End Stainless Steel Ball Valve with Lever Handle	337-338

Roll Groovers

Model 1007 & 3007 Roll Groovers	339-340
Model 3006 Roll Groover	341-342
Shop-Gruv	343

Coupling Installation and Assembly

Specified Bolt Torque	344
Fig. 7401 RigidLOK® Coupling	345
Fig. 74 SlideLOK® Ready for Installation Coupling Installation and Re-Installation	346-347
Fig. 70 SlideFLEX® Flexible Coupling Installation and Re-Installation	348-349
Fig. 7001 Flexible Coupling	350
Fig. 7001-2 & Fig. 7401-2 Two-Piece Large Diameter Couplings	351-352
Fig. 7011 Standard Coupling	353
Fig. 7000 Lightweight Flexible Coupling	354
Fig. 7400 Rigidlite® Coupling	355
Fig. 64 CTS SlideLOK Rigid Coupling Installation and Re-Installation	356-357
Fig. 617 Transition Coupling for Joining IPS to Copper Tubing Systems	358
Fig. 7003 Hingelok® Coupling	359
Fig. 7010 Reducing Coupling	360
Fig. 7012 Gruvlok® Flange (2"-12")	361-362
Fig. 7012 Gruvlok® Flange (14"-24")	363
Fig. 7042 Outlet Coupling	364
Fig. 7045 & Fig. 7046 Clamp-T® Branch Outlets	365
Fig. 7043 Branch Outlet	366
Fig. 7005 Roughneck® Coupling	367
Fig. 7004 High Pressure Coupling	368
Fig. 7004EG High Pressure Coupling	369
Fig. 7377 Double Groove Coupling	370
Fig. 7305 HDPE Coupling	371
Fig. 7307 HDPE Transition Coupling	372
Fig. 7312 HDPE Flange Adapter	373
Gruvlok® Sock-It® Fitting	374
Model FTV Tri-Service Valve	375-377
Model 4 Circuit Balancing Valves	378
AnvilFlex® Flex Connectors	379

Coupling Installation and Assembly (Continued)

Design Services

Digital Design Solutions.....	380
Design Smarter. Build Better.	381
For More Information.....	382
ASC Tools Autodesk® Revit® Plug In.....	383
BIM & CAD Content Library.....	384
Virtual Design & Construction Technology Services	385

Technical Data

Table of Contents	386
Gruvlok® Lubricants	387-388
Specified Bolt Torque & Design Factors	388
Gruvlok® Flow Control Components	389
Gruvlok® Gasket Styles	390
Gruvlok® Gasket Index & Recommendations	391-393

Movement-Applications.....	395-396
Coupling Working Pressure Rating on Light Wall Roll Grooved Steel Pipe	397
Coupling Working Pressure Rating on Roll Grooved ISO Steel Pipe	398
Coupling & Flange Working Pressure Rating on 304 & 316 Stainless Steel Roll Grooved Pipe.....	399
Coupling & Flange Working Pressure Rating on Aluminum Pipe.....	400
Coupling Working Pressure Rating on CPVC Pipe	401
Pipe Support	402-404
Coupling Flexibility	405-406
Drafting Symbols for Gruvlok® Piping Systems.....	407
Pipe-Preparation.....	408-409
Roll Groove Specification	410

Cut Groove Specification	411
Cut Groove End Guard® Specification	412
Roll Groove End Guard® Specification	412
Double Cut Groove Specification	413
Gruvlok® CTS Copper System Specification	414
CPVC Cut Groove Specification	415
Master Format 3 Part Specifications.....	41

Pictorial Index

Pipe Fitting Products	417-427
Pipe Hanger Products.....	428-431
Anvil-Strut® Products.....	432-440

Index

Numeric Index	441-442
---------------------	---------

Notes

Notes	443-446
-------------	---------

Gruvlok® Pictorial Parts Index – Couplings

Fig. 7401 Pages 19-20
Rigidlok® Coupling

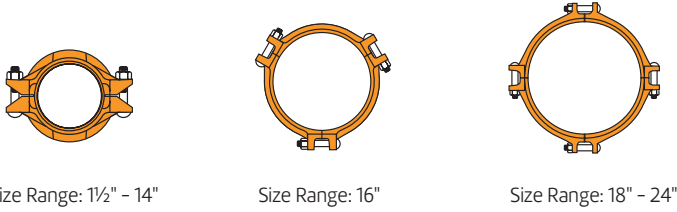

Fig. 70 Pages 26-27
SlideFLEX™ Ready for Installation Flexible Coupling
Size Range: 2" - 8"



Fig. 74 Pages 24-25
SlideLOK® Ready for Installation Coupling
Size Range: 2" - 8"

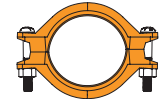

Fig. 7001 Pages 28-30
Flexible Coupling

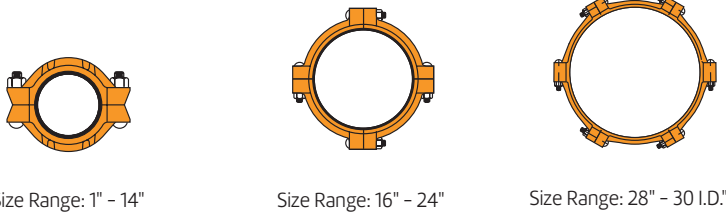

Fig. 7401-2 Pages 31-32
Rigidlok® Coupling
Size Range: 14" - 24"

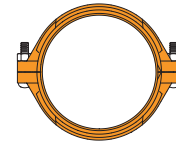

Fig. 7011 Pages 33-34
Standard Coupling
Size: 30 O.D."

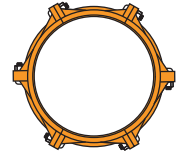

Fig. 7022 Pages 35-38
Weld Ring Gruv-Ring Coupling
Size Range: 30" - 60"

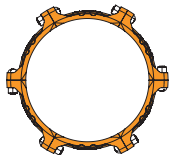

Fig. 7000 Pages 39-41
Lightweight Flexible Coupling
Size Range: 1" - 8"

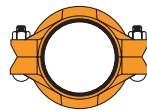

Fig. 7400 Pages 42-43
Rigidlite® Coupling
Size Range: 1" - 8"

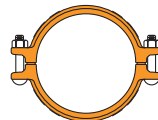

Fig. 7001-2 Pages 31-32
Flexible Coupling
Size Range: 14" - 24"

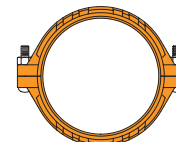

Fig. 7010 Pages 46-47
Reducing Coupling
Size Range:
2" x 1½" thru 8" x 6"

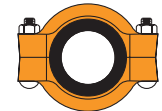

Fig. 7788 Pages 48-49
Gruvlok Flange Adapter
Size Range: 2" - 12"

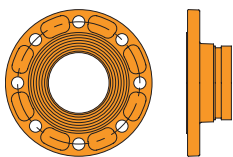
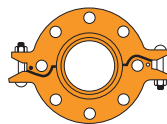
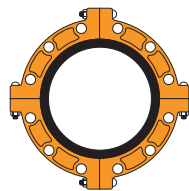

Fig. 7012 Pages 50-52
Gruvlok Flanges



Size Range: 2" - 12"



Size Range: 14" - 24"

Fig. 7003 Pages 44-45
Hingelok® Coupling
Size Range: 1" - 4" and 5" - 8"

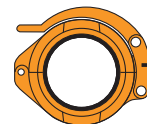

Flanged Seal Rings Pages 56-57
Flange Adapter Inserts for use with Fig. 7012/7013 Flanges
Size Range: 2" - 24"

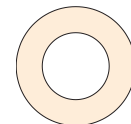

Fig. 7240 Pages 58-60
Expansion Joint
Size Range: 2" - 12"

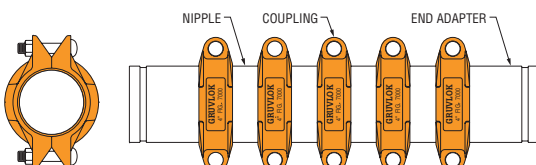
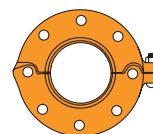

Fig. 7013 Pages 53-55
Gruvlok Flanges
(#300 Flange)
Size Range: 2" - 12"



Gruvlok® Pictorial Parts Index – Branch Fittings

Fig. 7042 Pages 61-63

Outlet Coupling
Size Range: 1½" - 6"

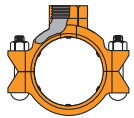

Fig. 7042F
Female IPS Outlet

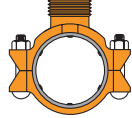

Fig. 7042M
Male IPS Outlet

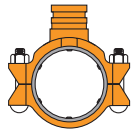
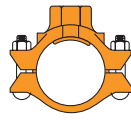

Fig. 7042G
Grooved Outlet

Fig. 7045 Pages 64-67



Clamp-T, FPT Branch
Size Range:
3" x 1¼" through 8" x 4"



(U-Bolt)
Size Range:
2½" x ½" through 4" x 1"

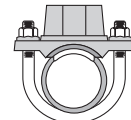

Branch Outlet
Size Range:
1¼" x ½" thru 2½" x 1"

Fig. 7046 Pages 68-70



Clamp-T,
Grooved Branch
Size Range:
3" x 1¼" through 8" x 4"

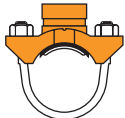

(U-Bolt)
Size Range:
2½" x 1¼" through
2½" x 1½"

Fig. 7047, Fig. 7048 & Fig. 7049 Page 71

Clamp-T Cross
Size Range: 2" x ½" through 8" x 4"

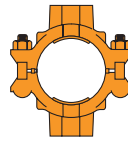

Fig. 7047
Thread x Thread

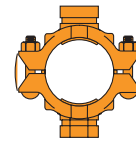

Fig. 7048
Groove x Groove

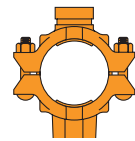

Fig. 7049
Groove x Thread

Grooved Fittings

Fig. 7050 Pages 74-77

90° Elbow
Size Range: 1" - 24"



Fig. 7051 Pages 74-77

45° Elbow
Size Range: 1" - 24"



Fig. 7052 Pages 74-77

22½° Elbow
Size Range: 1" - 24"



Fig. 7053 Pages 78-81

1¼° Elbow
Size Range: 1" - 24"



Fig. 7050LR Pages 78-81

90° Long Radius Elbow
Size Range: 1" - 24"



Fig. 7051LR Pages 78-81

45° Long Radius Elbow
Size Range: 1" - 24"



Fig. 7060 Pages 82-84

Tee
Size Range: 1" - 24"

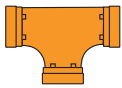

Fig. 7061 Page 85-88

Reducing Tee Standard
Size Range:
1¼" x 1¼" x 1" thru
24" x 24" x 20"

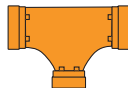

Fig. 7063 Pages 89-91

Tee with Threaded Branch
Size Range: 1" - 12"

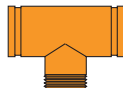

Fig. 7064 Pages 92-95

Reducing Tee with
Threaded Branch
Size Range: 2" x 2" x ¾"
thru 24" x 24" x 12"

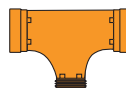

Fig. 7073 & Fig. 7097 Pages 96-98

Eccentric Reducers
Size Range: 1¼" x 1" through 24" x 20"



Fig. 7073
Groove x Groove



Fig. 7097
Groove x Thread

Fig. 7076 Pages 82-84

GR x Thd
Concentric Reducer
Size Range:
1½" x 1" thru 6" x 4"



Fig. 7077, 7078 & 7079 Pages 99-101

Swaged Nipples
Size Range: 2" x 1" thru 6" x 5"



Fig. 7077
Groove x Groove



Fig. 7078
Groove x Thread



Fig. 7079
Groove x Bevel

Fig. 7072 Pages 105-107

GR x GR
Concentric Reducer
Size Range: 1¼" x 1"
thru 24" x 20"



Fig. 7070 Pages 105-108

45° Reducing Lateral
Size Range: 3" x 3" x 2"
thru 24" x 24" x 20"

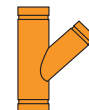

Fig. 7069

Pages 105-108
45° Lateral
Size Range: 1" - 24"



Fig. 7071 Pages 109-112

True Wye
Size Range: 1" - 24"

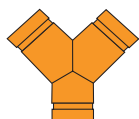

Fig. 7066 Pages 109-112

Tee Wye
Size Range: 2" x 2" x 2"
thru 12" x 12" x 12"

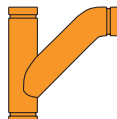

Fig. 7067 Pages 109-112

Reducing Tee Wye
Size Range: 4" x 3" x 3"
thru 8" x 6" x 8"

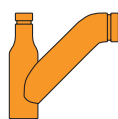

Fig. 7087 Pages 113-115

Female Thread Adapter
Size Range: 1" - 4"



Fig. 7055 Pages 113-115

90° Adapter Elbow
Size Range: 1" - 6"



Fig. 7056 Pages 113-115

45° Adapter Elbow
Size Range: 1" - 6"



Gruvlok® Pictorial Parts Index – Grooved Fittings

Fig. 7050RF Pages 113-115
Reducing Base Support Elbow
Groove x 150# Flange (GxF)
Size Range:
5" x 4" thru 12" x 10"



Fig. 7072GF Pages 116-119
Gr x Flange Concentric Reducer
Size Range:
3" x 2" thru 8" x 6"



Fig. 7084 Pages 120-122
Groove x Class 150 Flange Nipple
Size Range: 1" - 24"

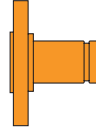

Fig. 7085 Pages 120-122
Groove x Class 300
Flange Nipple
Size Range: 1" - 24"

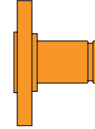

Fig. 7074 Pages 123-125
Cap
Size Range: 1" - 24"



Fig. 7075 Pages 123-125
Bull Plug
Size Range: 2" - 6"



Fig. 7068 Pages 123-125
Cross
Size Range: 1" - 24"

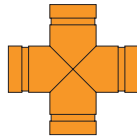

Fig. 7086 Pages 126-128
Groove x Hose Nipple
Size Range: 1" - 12"



Fig. 7065 Pages 129-131
Standpipe Tee
(Gr x Gr x FPT)
Size Range:
4" x 4" x 2 1/2" thru
6" x 6" x 2 1/2"



Fig. 7062 Pages 129-131
Bullhead Tee Specialty
Tees (Gr x Gr x FPT)
Size Range:
5" x 5" x 8" thru
6" x 6" x 8"



Fig. 7050DR Pages 129-131
90° Drain Elbow
Size Range: 1 1/4" - 12"



**Fig. 7080,
Fig. 7081 &
Fig. 7082**
Pages 126-128
Nipples
Size Range: 3/4" - 12"



Fig. 7080
Groove x Groove



Fig. 7081
Groove x MPT



Fig. 7082
Groove x Bevel

Fig. 7450 Pages 132-134
90° Short Pattern Elbow
Size Range: 2" - 8"



Fig. 7460 Pages 135-136
Short Pattern Tee
Size Range: 2" - 8"

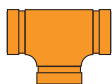

Fig. 7050-3D Pages 137-140
Long Radius Elbows
Size Range: 2" - 24"

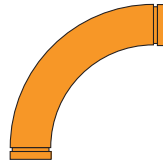

Fig. 7050-3D
90° Elbow



Fig. 7057-3D
60° Elbow



Fig. 7051-3D
45° Elbow



Fig. 7058-3D
30° Elbow



Fig. 7052-3D
22 1/2° Elbow



Fig. 7053-3D
11 1/4° Elbow

Fig. 7050-5D Pages 141-144
Long Radius Elbows
Size Range: 2" - 24"

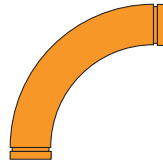

Fig. 7050-5D
90° Elbow



Fig. 7057-5D
60° Elbow



Fig. 7051-5D
45° Elbow



Fig. 7058-5D
30° Elbow



Fig. 7052-5D
22 1/2° Elbow



Fig. 7053-5D
11 1/4° Elbow

Fig. 7050-6D Pages 145-148
Long Radius Elbows
Size Range: 2" - 24"

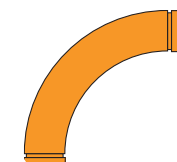

Fig. 7050-6D
90° Elbow

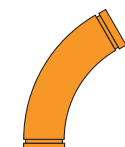

Fig. 7057-6D
60° Elbow



Fig. 7051-6D
45° Elbow



Fig. 7058-6D
30° Elbow



Fig. 7052-6D
22 1/2° Elbow

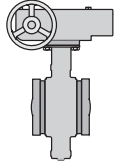

Fig. 7053-6D
11 1/4° Elbow

Gruvlok® Pictorial Parts Index – Valves & Accessories

Series 7700 Pages 149-152

Butterfly Valve – Epoxy
 Size Range: 2" – 12"



AE-7722-3
 Series 7700
 Butterfly Valve
 with Gear Operator

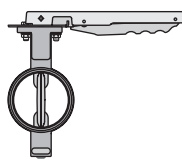

AE-7721-3
 Series 7700
 Butterfly Valve
 with 10 Position Lever Lock

Series 8000GR Pages 153-156

Butterfly Valve
 Size Range: 14" – 24"

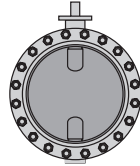
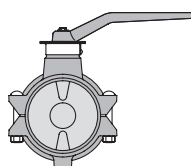

Fig. 70G Pages 157-158

Butterfly Valve
 Size Range: 2" – 6"



Model B333 Pages 162-164

Butterfly Valve
 Size Range: 14" – 24"

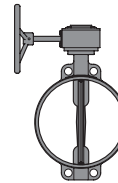

Series 8100 Page 165-166

Low Profile
 Butterfly Valve
 Size Range: 2" – 6"

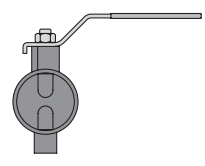

Model B8200L Pages 167-168

PVC Butterfly Valve
 Size Range: 2" – 8"

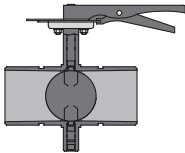

Series 7500 Pages 169-172

Ball Valve
 Size Range: 2" – 6"

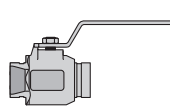

Fig. 90G Pages 175-176

Check Valve
 Size Range: 2" – 4"

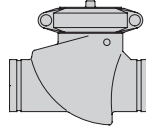
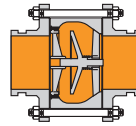

Fig. 400G Pages 177-178

Grooved-End
 Silent Check Valve
 Size Range: 2" – 10"



Model BV835 Pages 173-174

Grooved End Ball Valve with
 Lever or Gear Operator
 Size Range: 2" – 6"

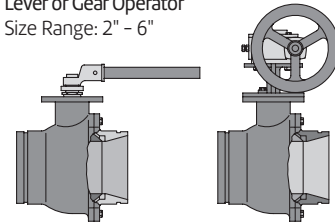

Series 7800 Pages 179-181

Check Valve for use
 in Grooved-End
 Piping Systems
 Size Range: 2" – 12"

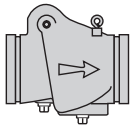
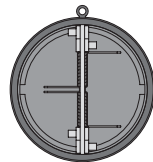

Fig. CV890 Pages 182-183

Dual Disc Check Valve
 Size Range: 14" – 24"



ABV-9900V Series Pages 184-187

Straight DZR Brass Automatic
 Balancing Valve
 Solder (ABV-S-9909)
 Threaded (ABV-T-9907)
 Size Range: 1/2" – 2 1/2"

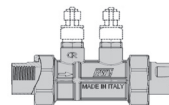

MBV-9510 Series Pages 188-191

Fixed Orifice Double
 Regulating Valve
 Solder (MBV-S-9519)
 Threaded (MBV-T-9517)
 Size Range: 1/2" – 2"

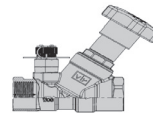

MBV-9510AB Series Pages 192-195

Fixed Orifice Double Regulating
 Low Lead Valve
 Solder (MBV-S-9519AB)
 Threaded (MBV-T-9517AB)
 Size Range: 1/2" – 2"

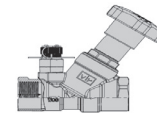

CSV-9520AB Series Pages 196-200

DZR Brass On/Off Terminal
 Low Lead Balancing Valve
 Solder (CSV-S-9529AB)
 Threaded (CSV-T-9527AB)
 Size Range: 1/2" – 1"

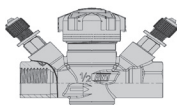

Fig. Anvil 92ST Pages 203-204

DZR Brass Ball Valve
 with Strainer
 Size Range: 1/2" – 2"

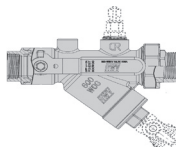

Fig. Anvil 92BPC Pages 205-206

DZR Brass Ball Valve
 with Bypass
 Size Range: 1/2" – 2"

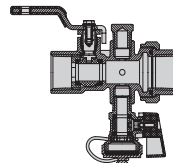

Fig. Anvil 991BV Pages 207-208

Ball Valve with Nut for 9900V
 Series Valves
 Size Range: 1/2" – 2 1/2"

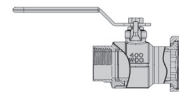

Fig. Anvil 92UN Pages 209-210

DZR Brass Union Body
 with Air Vent and
 Test Point
 Size Range: 1/2" – 2"

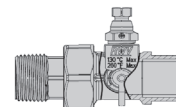

Fig. Anvil 92HS Pages 211-212

Stainless Steel
 Braided Hose
 Size Range: 1/2" – 2"



GBV-A & GBV-G Pages 213-216

Balancing Valve Ductile Iron,
 Grooved-End Straight or Angle
 Size Range: 2 1/2" – 12"

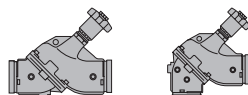

Model CB800 Pages 217-226

Circuit Balancing Valve, Grooved-End
 or Flanged End
 Size Range: 2 1/2" – 12"

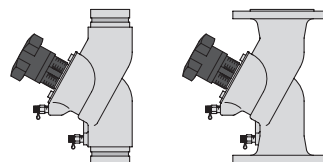

Gruvlok® Pictorial Parts Index – Valves & Accessories

FTV-S Pages 227-228
Tri-Service Valve (Straight)
Size Range: 2½" - 12"

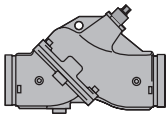

FTV-A Pages 227-228
Tri-Service Valve (Angle Body)
Size Range: 2½" - 12"

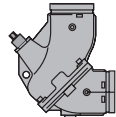
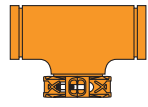

Fig. 7260 Pages 233-234
Gruvlok Tee Strainer
Size Range: 2" - 18"



Model 758G Pages 229-230
Grooved-End "Wye" Strainer
Size Range: 2" - 12"



Model 768G Pages 231-232
Grooved-End "Wye" Strainer
Size Range: 2" - 12"

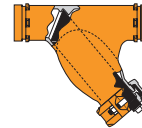

Fig. 7250 Pages 235-237
Suction Diffuser
Size Range: 2½" x 2½" thru 16" x 14"

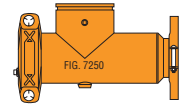
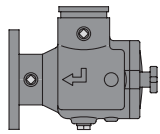
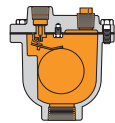

Fig. S810 Pages 238-242
Suction Diffuser
Size Range: 2" x 2" - 16" x 14"



Model GAV-15 Pages 243-244
Automatic Air Vent for Ultimate Performance
Size Range: ½" - 1"



Model GAV-30 Pages 245-246
Automatic Air Vent for Ultimate Performance
Size Range: ½" - ¾"

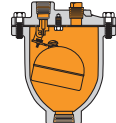

AnvilFlex® AF-21 Series Pages 247-256
Flex Connectors
Size Range: 2" - 12"



Fig. AF-21-GG
Grooved Ends



Fig. AF-21-GF
Grooved x Class 150 Flanged



Fig. AF-21-FF
Class 150 Flanged x Class 150 Flanged

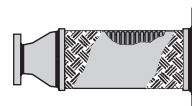

Fig. AF-21-RFF
Reducing Class 150 Flanged x Class 150 Flanged



Fig. AF-21-RGF
Reducing Grooved x Class 150 Flanged

High Pressure Systems

Fig. 7004 Pages 257-258
Coupling
Size Range: 2" - 12"

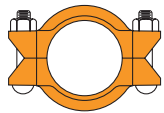

Fig. 7004EG Pages 259-260
High Pressure Coupling with EG Gasket
Size Range: 2" - 12"

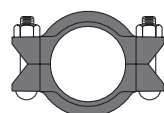

Fig. 770 Pages 261-262
Rigid Coupling
Size Range: 2" - 12"

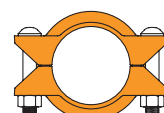

Fig. 7377 Pages 263-265
Double Groove Coupling
Size Range: 6" - 10"

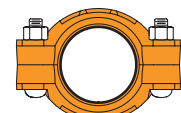

Fig. 7050 EG Pages 266-267
High Pressure 90° LR Elbow
Size Range: 2" - 12"



Fig. 7051 EG Pages 266-267
High Pressure 45° LR Elbow
Size Range: 2" - 12"



Fig. 7662 EG Pages 268-269
High Pressure Header Tee
Size: 2"

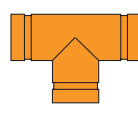

Fig. 7060 EG Pages 268-269
High Pressure Tee
Size Range: 2" - 12"

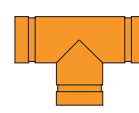
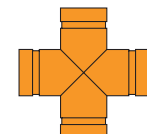

Fig. 7068 EG Pages 268-269
High Pressure Cross
Size Range: 2" - 12"



Gruvlok® Pictorial Parts Index – CTS Copper System

Fig. 64 Pages 271-272

CTS SlideLOK® Ready for Installation Coupling
Size Range: 2" - 8"

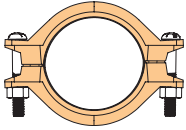

Fig. 617 Pages 273-274

Transition Coupling for Joining IPS to Copper Tubing Systems
Size Range: 2" - 4"

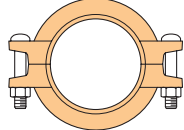

Fig. 6084 Page 275

Flange Adapter
Size Range: 2" - 6"

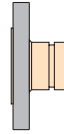

Fig. 610

Pages 276-277

90° CTS Elbow
Size Range: 2" - 8"

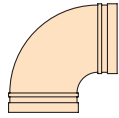

Fig. 601

Pages 276-277

45° CTS Elbow
Size Range: 2" - 8"

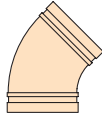

Fig. 660

Pages 276, 278

CTS Cap
Size Range: 2" - 8"

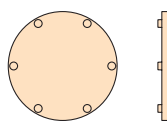

Fig. 619

Pages 276, 278

CTS Tee
Size Range: 2" - 8"

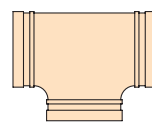

Fig. 621

Pages 276, 279

CTS Reducing Tee (Gr x Gr x Gr)
Size Range: 2" - 8"

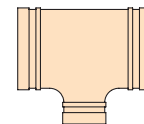

Fig. 618

Pages 276, 279

CTS Reducing Tee (Gr x Gr x Cup)
Size Range: 2" - 8"

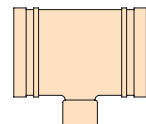

Fig. 650

Pages 276, 280

CTS Concentric Reducer (Gr x Gr)
Size Range: 2" - 8"

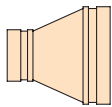
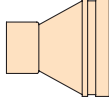

Fig. 652

Pages 276, 280

CTS Concentric Reducer (Gr x Cup)
Size Range: 2" - 8"



Series 6700 Pages 281-283

CTS Copper Butterfly Valve
Size Range: 2½" - 6"

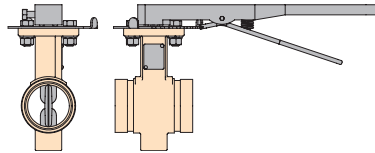

Di-Electric Nipples

Fig. 7088 Pages 284-285

Di-Electric Pipe Connection
Thread x Groove
Size Range: 1" - 4"



Fig. 7089 Pages 284-285

Di-Electric Pipe Connection
Groove x Groove
Size Range: 2" - 4"



Fig. 7090 Pages 284-285

Di-Electric Pipe Connection
Thread x Thread
Size Range: ½" - 3"



Fig. 7091 Pages 286-287

Gruvlok DI-LOK® Nipple
Di-Electric Pipe Connection
CTS Groove x IPS Groove
Size Range: 2" - 8"

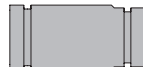

HDPE Couplings

Fig. 7305 Pages 302-304

HDPE Coupling
Size Range: 2" - 18"

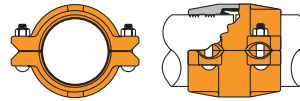

Fig. 7307 Pages 305-306

HDPE Transition Coupling
Size Range: 2" - 12"

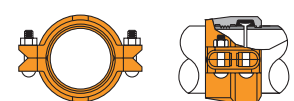
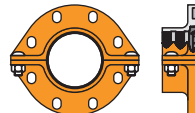

Fig. 7312 Pages 307-309

HDPE Flange Adapter
Size Range: 4" - 8"



Gruvlok® Pictorial Parts Index – Plain-End Fittings

Fig. 7005 Pages 288–289
Roughneck® Coupling
Size Range: 2" – 16"

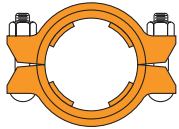

Fig. 7050P, 7051P & 7060P Pages 290–291
Gruvlok Plain-End Fittings
Size Range: 2" – 8"



Fig. 7050P
90° Elbow



Fig. 7051P
45° Elbow



Fig. 7060P
Tee

Fig. 7061P Pages 294–295
Reducing Tee
Size Range: 3" x 3" x 2" thru
12" x 12" x 10"

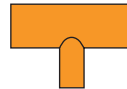

Fig. 7050LRP
Pages 296–297
90° LR Elbow
Size Range: 2" – 8"

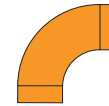

Fig. 7051LRP
Pages 296–297
45° LR Elbow
Size Range:
2" – 8"



Fig. 7071P Pages 293–293
90° True Wye
Size Range: 2" – 8"



Fig. 7068P Pages 292–293
Cross
Size Range: 2" – 8"

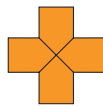

Fig. 7069P Pages 292–293
45° Lateral
Size Range: 2" – 8"



Fig. 7075P Pages 296–297
Bull Plug
Size Range: 2" – 8"



Fig. 7084P & 7085P
Pages 294–295
Flange Nipples
Size Range: 2" – 8"

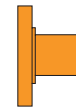

Fig. 7077P
Pages 300–301
Swaged Nipple
Size Range:
2½" x 2" thru
8" x 6"



Fig. 7080P, 7081P & 7082P Pages 298–299
Adapter Nipples
Size Range: 2" – 8"



Fig. 7080P
Plain x Groove



Fig. 7081P
Plain x Thread



Fig. 7082P
Plain x Bevel

Sock-It® Method

Fig. 7100 Pages 310–311
90° Elbow
(Sock-It x Sock-It)
Size Range: 1" – 2"



Fig. 7101 Pages 312–313
90° Reducing Elbow
(Sock-It x NPT)
Size Range:
1" x ½" thru 1½" x 1"

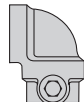

Fig. 7103 Pages 314–315
Straight Tee
(Sock-It x Sock-It x
Sock-It)
Size Range: 1" – 2"

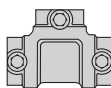

Fig. 7105 Pages 318–319
Reducing Outlet Tee
(Sock-It x Sock-It x NPT)
Size Range: 1" x 1" x ½" thru
2½" x 2½" x 1"

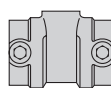

Fig. 7106 Pages 320–321
Reducing Tee
(Sock-It x Sock-It x NPT)
Size Range:
1¼" x 1" x ½" thru
2" x 1½" x 1"

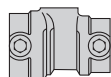
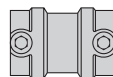

Fig. 7107 Page 316–317
Coupling
(Sock-It x Sock-It)
Size Range: 1" – 2"



Stainless Steel Method

Fig. 7001SS Pages 322–323
Stainless Steel Flexible Coupling
Size Range: 1" – 8"

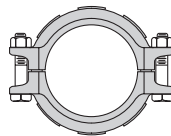

Fig. 7401SS Pages 324–325
Stainless Steel Rigid Coupling
Size Range: 1¼" – 8"

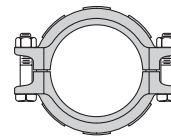

Fig. 7050SS Pages 326–327
90° Stainless Steel Elbow
Size Range: 1" – 12"

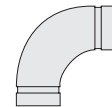

Fig. 7051SS
Pages 326, 327
45° Stainless
Steel Elbow
Size Range: 1" – 12"



Fig. 7060SS
Pages 326, 327
Stainless Steel Tee
Size Range: 1" – 12"

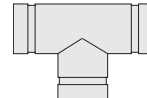

Fig. 7061SS Pages 326, 328
Stainless Steel Reducing Tee
Size Range: 1½" x 1½" x 1"
thru 12" x 12" x 10"

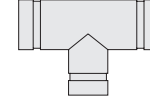

Fig. 7074SS
Pages 326, 329
Stainless Steel Cap
Size Range: 1" – 12"



Fig. 7084SS
Pages 326, 330
Stainless Steel
Flange Adapter
Size Range: 1" – 12"

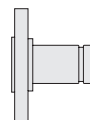

Fig. 7072SS
Pages 326, 331
Stainless Steel
Concentric Reducer
Size Range:
1½" x 1" thru 12" x 10"



Fig. 7073SS
Pages 326, 332
Stainless Steel
Eccentric Reducer
Size Range:
1½" x 1" thru 12" x 10"



Fig. 7788SS
Pages 326, 330
Cast SST
Flange Adapter
Size Range:
2" – 8"



Model B480 Pages 333–336
Grooved End Stainless Steel Butterfly Valve
Size Range: 2" – 6"



Model BV435 Pages 337–338
Grooved End Stainless
Steel Ball Valve
Size Range: 1½" – 4"

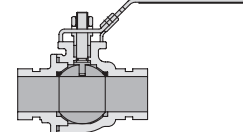

Gruvlok® Pictorial Parts Index – Roll Groovers

Gruvlok roll grooving technology is protected by U.S. Patents 5450738, 5570603, 5778715 and others pending.

Model 1007 Pages 339-340

Roll Groover
Groover Capability: 2" - 16"

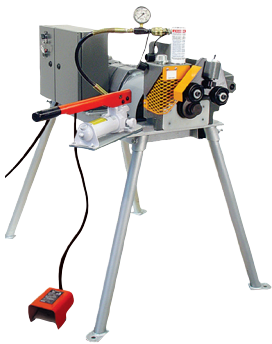

Model 3007 Pages 339-340

Roll Groover
Groover Capability: 2" - 16"



Model 3006 Pages 341-342

Roll Groover
Groover Capability: 2" - 12"



Nap® Shop-Gruv™ Page 343

Automated Roll Groover



Products for Grooved Piping System

The Gruvlok® System has been manufactured since the late 1960's. The Gruvlok product line has grown from standard couplings and fitting to today's extensive range of grooved product, plain-end product, butterfly valves, check valves, pump protection components, pipe

preparation tools and various accessories. Gruvlok is part of our overall commitment to provide today's piping industry with tomorrow's products.



Certified to
NSF/ANSI 61-G

For Listings/Approval Details and Limitations, visit our website at www.asc-es.com or contact an ASC Engineered Solutions Sales Representative.

ISO 9001:2015

Industry & Government Standards & Approvals

ANSI American National Standards Institute	FAA Federal Aviation Administration: HVAC, Plumbing, Fire Protection	NY-BSA New York Board of Standards and Appeals
API American Petroleum Institute: API Std. 5L, Sect. 7.5	FHA Federal Housing Administration	NYC New York City
ASHRAE American Society of Heating, Refrigerating and Air Conditioning Engineers	FM Factory Mutual Engineering Corp.	TVA Tennessee Valley Authority: Fire protection, storm drains
ASME American Society of Mechanical Engineers: Power Piping, B 31.1; Chemical Plant and Petroleum Refinery Piping, B 31.3; Refrigeration Piping, B 31.5; Building Services Piping, B 31.9; Slurry Pipelines, B 31.11	GSA General Services Administration: 15000 Series	UL Underwriter's Laboratories, Inc.
ASTM American Society of Testing and Materials: F 1476, F 1387	IAPMO International Association of Plumbing & Mechanical Official	ULC Underwriter's Laboratories of Canada
AWWA American Water Works Association: C 606	LPC Loss Prevention Council	Bureau of Marine Inspection: Salt and fresh water, oil transfer
BV Bureau Veritas	MEA Materials & Equipment Acceptance	Bureau of Public Roads; Div. of Bridges: Drain lines and bridge crossings
CDF California State Fire Marshal	MIL Military specifications: MILP-10388 Fittings; MIL-C-10387 Couplings; MIL-P-11087A(CE) Steel Pipe, Grooved MIL-I-45208 Inspection Procedure	Canadian Coast Guard
COE Corps of Engineers: CEGS 15000	NASA National Aeronautics and Space Administration: 15000 Series	U.S. Coast Guard – Approves each vessel individually
CSA Canadian Standards Association: B 242	NAVFAC Naval Facilities Engineering Command: NFGS 15000 Series	USGBC United States Green Building Council
DNV Det Norske Veritas Hong Kong Fire Services Board New Zealand Insurance Council New Zealand Building Act. (1991)	NFPA National Fire Protection Association	VA Veterans Affairs: 15000 Series
	NIH National Institute of Health (Dept. of Health): 15000 Series	VdS Verband der Sachversicherer e.V.
	NSF NSF International	

Note: Please refer to product specific pages for exact listings and approvals related to a specific sizes for a specific product.

Gruvlok® – The Engineered Coupling

Housing (A) Flexible or Rigid

The Gruvlok Coupling housing is designed to self-center around the pipe. The housing encircles and retains the gasket against the application of internal system pressure or vacuum.

The housing key sections fit into and engage the pipe-end grooves around the entire pipe circumference, thus restraining the pipe ends from separation due to the application of internal pressure.

Flexible Couplings provide designed-in clearances between the housing key sections and the pipe grooves to permit both angular and longitudinal movement of the pipe. Rigid couplings grip the pipe and lock the joint into position.

All housings are coated with paint for general service applications. The paint serves to provide protection against normal atmospheric corrosion. However, for couplings used in corrosive environments, hot-dip galvanizing, and stainless steel are available.

Gasket (B)

The unique single piece "C" style design of the gasket has been engineered to provide a pressure responsive, leak-tight seal in both pressure and vacuum applications without the aid of external forces. The "lips" of the gasket are molded so that upon installation onto the pipe ends they provide compression against the pipe surface to establish the leak-tight seal.

The gasket cavity functions as a "pressure reservoir". Pressure within the pipe system is applied to the internal surfaces of the gasket which increases the sealing force and enhances the leak-tight seal. In vacuum systems, non-pressure-responsive seals tend to "lift off" the pipe, producing leak paths. However, the Gruvlok gasket reacts to the negative pressure (higher outside atmospheric pressure) as to improve the sealing capability of the gasket.

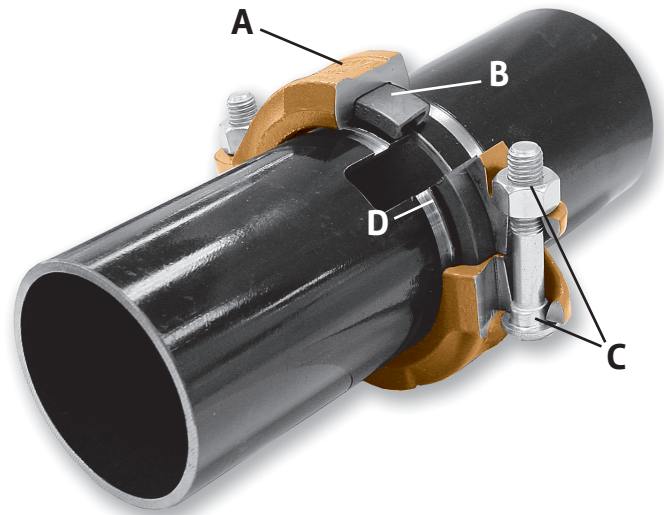
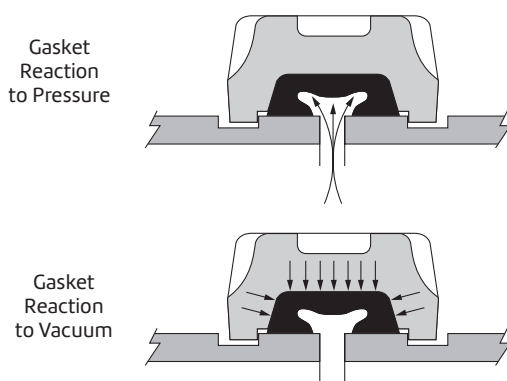

Bolts and Nuts (C)

Heat treated oval neck track head bolts serve to connect and secure the housing segments together. The oval neck design prevents turning of the bolt while tightening the hex nut with a single wrench. The bolt size and corresponding wrench (or socket) size for the hex nuts are shown in the chart below.

ANSI

Bolt Size	3/8"	1/2"	5/8"	3/4"	7/8"	1"	1 1/4"
Wrench Size	1 1/16"	7/8"	1 1/16"	1 1/4"	1 7/16"	1 5/8"	2"

Metric

Bolt Size	M10	M12	M16	M20	M22
Wrench Size	16	22	24	30	34

Grooved Pipe Ends (D)

The ends of the pipe must have a groove in them which may be either cut grooved or roll grooved. The grooved pipe ends engage the coupling keys, thus, providing a self-restraining, mechanical joint capable of resisting the separation of the pipe ends due to the application of system pressure. The grooved diameters must be dimensionally accurate to obtain the maximum benefit of the Gruvlok Coupling.

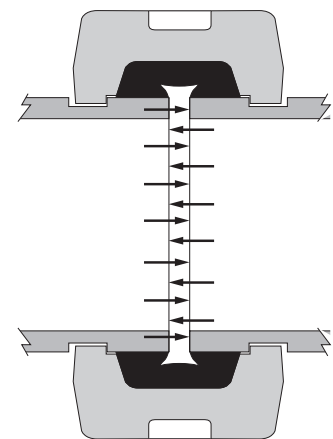

The Gruvlok® Piping Method

Gruvlok couplings and grooved-end fittings are widely used for joining pipe in a wide variety of piping systems. Gruvlok couplings for grooved-end pipe are designed to provide a self-centering joint which accommodates the application of pressure, vacuum and other external forces, while limiting the burdensome need for special supports, expansion joints, etc.

The Gruvlok piping method offers many mechanical design features which benefit the design engineer, the contractor, and the end user. Utilization of the functional characteristics of the Gruvlok coupling will aid in pipe system design and must be considered for proper installation, assembly and performance.

The design factors presented in the Gruvlok technical data section should always be referenced to when designing any grooved piping system to obtain the maximum benefit the Gruvlok piping method.



Gruvlok Features

Rigidity or Flexibility

Couplings are available where rigid connections are required. Rigid couplings are clearly marked with an "X" for identification.

Couplings with flexible design allow for pipe expansion and contractions with temperature changes. The need for an expansion joint is minimized or eliminated.

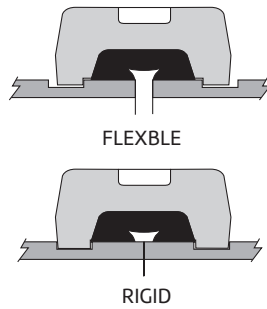

Self Restrained Joint

The couplings engage the pipe around the entire circumference and restrain the pipe ends from separation due to pressure and other forces, up to the maximum coupling rated working pressure.

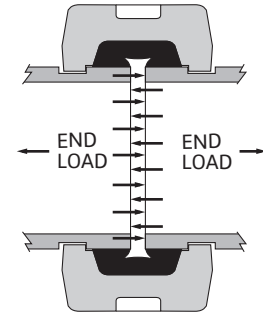

Union at Every Joint

Gruvlok couplings can be disassembled easily permitting maintenance and servicing of the piping system. It will facilitate periodic rotation of pipe to distribute internal wear from slurries or other abrasive media.

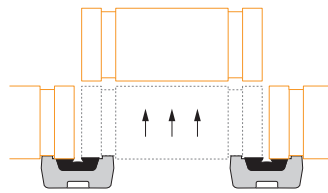

Stress-Free System

Flexibility designed in the Gruvlok coupling absorbs and eliminates stress from settlement of buried pipe or those induced by seismic tremors.

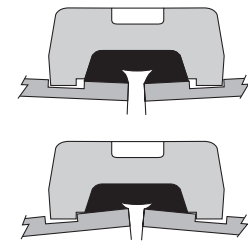

Minimizes Noise & Vibration

The resilient elastomeric gasket and pre-designed gap of the Gruvlok coupling help isolate and absorb noise and vibration, this minimizes vibration transmission.

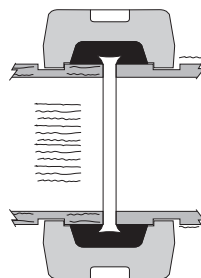

Accommodates Misalignment and Joint Deflection

The flexibility designed into the Gruvlok coupling will accommodate misalignments caused by imprecise location

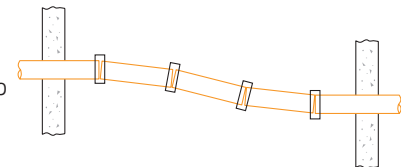

of pipe opening through walls and floors, will provide pitch for drainage piping systems and facilitate laying pipe on uneven terrain, thus permitting deflection in any direction.

Gruvlok® Couplings for Grooved-End Pipe

Gruvlok couplings for grooved-end pipe are available in nominal pipe sizes 1" through 60" and metric sizes. The variety of coupling designs provide a universal means for the connection of pipe, fittings and pipe system components. The wide assortment of Gruvlok couplings and gaskets permit selection of the most suitable combination for a specific application, thus providing the most versatile and economical pipe system installation.



Material Specifications

Bolts

SAE J429, Grade 5, Zinc Electroplated
ISO 898-1, Class 8.8, Zinc Electroplated followed by a Yellow Chromate Dip

Heavy Hex Nuts

ASTM A563, Grade A, Zinc Electroplated
ISO 898-2, Class 8.8, Zinc Electroplated followed by a Yellow Chromate Dip

Stainless Steel Bolts & Nuts

Stainless steel bolts and nuts are available upon request

Housing

Ductile Iron conforming to ASTM A 536, Grade 65-45-12

Coatings

Rust inhibiting paint Color: ORANGE
(standard Hot Dipped Zinc Galvanized optional)
Other Colors Available (IE: RAL3000 and RAL9000)
For other Coating requirements contact an ASC Representative.

Gaskets: Materials

Properties as designated in accordance with ASTM D 2000

Grade "EP" EPDM (Green/Red color code) NSF-61 Certified

-40°F to 250°F (Service Temperature Range) (-40°C to 121°C)
Recommended for water service, diluted acids, alkalies solutions, oil-free air and many other chemical services.
NOT FOR USE IN PETROLEUM APPLICATIONS.

Grade "E" EPDM (Green color code) NSF-61 Certified

-40°F to 230°F (Service Temperature Range) (-40°C to 110°C)
Recommended for water service, diluted acids, alkalies solutions, oil-free air and many chemical services.
NOT FOR USE IN PETROLEUM APPLICATIONS.

Grade "T" Nitrile (Orange color code)

-20°F to 180°F (Service Temperature Range) (-29°C to 82°C)
Recommended for petroleum applications. Air with oil vapors and vegetable and mineral oils.
NOT FOR USE IN HOT WATER OR HOT AIR

Grade "O" Fluoro-Elastomer (Blue color code)

Size Range: 1" - 12" (C style only)
20°F to 300°F (Service Temperature Range) (-29°C to 149°C)
Recommended for high temperature resistance to oxidizing acids, petroleum oils, hydraulic fluids, halogenated hydrocarbons and lubricants

Grade "L" Silicone (Red color code)

Size Range: 1" - 12" (C style only)
-40°F to 350°F (Service Temperature Range) (-40°C to 177°C)
Recommended for dry, hot air and some high temperature chemical services

Gasket Type:

Standard C Style
Flush Gap: 1" - 24"
End Guard: 2" - 12" (Fig. 7004 and 7377)
SlideLOK: 2" - 8"

Lubrication

Standard Gruvlok Lubricant
Gruvlok Xtreme™ Lubricant
(Do Not use with Grade "L")

Working Pressure, End Load, Pipe End Separation & Deflection from Center Line

Based on standard wall steel pipe with cut or roll grooves in accordance with Gruvlok specifications. Pressure ratings for light wall, stainless steel, aluminum, and ISO pipe available. See Technical Data section.

Rigidlok® Coupling Fig. 7401



The Fig. 7401 Rigidlok Coupling is an ideal connector for service and applications that require a rigid connection.

The Fig. 7401 Rigidlok coupling utilizes a technologically advanced housing design that conforms to and grips the pipe.

Coupling installation is fast and easy, remove only one nut and swing the housing over the gasket and into the grooves. The exclusive Guidelok feature automatically separates the grooved pipe ends and guides the coupling into position as the bolts are tightened. Precisely sized and oriented tines in the housing key section firmly grip the pipe. The combination of these designed in features produce a secure, rigid pipe joint connection.

The Fig. 7401 Rigidlok Coupling is designed for use with roll grooved or cut grooved standard weight and roll grooved lightweight pipe, as well as with grooved-end fittings and valves. The Rigidlok Coupling provides a rigid pipe connection allowing pipe hanging practices per ASME B31 pipe codes.

The Fig. 7401 Rigidlok Coupling allows for a maximum working pressure of 750 psi (51.7 bar) when used on standard wall roll or cut grooved pipe.

Material Specifications

Bolts

SAE J429, Grade 5, Zinc Electroplated (standard)

Heavy Hex Nuts

SAE A563, Grade A, Zinc Electroplated (standard)

Hardware Kits

304 Stainless Steel (available in sizes up to ¾")

Kit includes:

- (2) Bolts per ASTM A193, Grade B8 and
- (2) Heavy Hex Nuts per ASTM A194, Grade 8.

Hardware Kits

EcoGuard (available in sizes up to ¾")

Kit includes:

- Bolts per SAE J429, Grade 5, with EcoGuard corrosion-resistant zinc flake coating and
- (2) Heavy Hex Nuts per ASTM A563, Grade A, EcoGuard corrosion-resistant zinc flake coating.

Housing

Ductile Iron conforming to ASTM A536, Grade 65-45-12.

Coatings

Rust inhibiting paint

Color: Orange (standard)

Hot Dipped Zinc Galvanized (optional)

Gaskets

Properties as designated in accordance with ASTM D2000

Grade "EP" EPDM (Green and Red color code)

-40°F to 250°F (Service Temperature Range)

(-40°C to 121°C)

Recommended for water service, diluted acids, alkalies solutions, oil-free air and many other chemical services.

NOT FOR USE IN PETROLEUM APPLICATIONS.

For hot water applications the use of Gruvlok Xtreme Temperature lubricant is recommended. NSF-61.

Grade "T" Nitrile (Orange color code)

NOT FOR USE IN DRINKING WATER

-20°F to 180°F (Service Temperature Range)

(-29°C to 82°C)

Recommended for petroleum applications. Air with oil vapors and vegetable and mineral oils.

NOT FOR USE IN HOT WATER OR HOT AIR

Grade "O" Fluoro-Elastomer (Blue color code)

NOT FOR USE IN DRINKING WATER

Size Range: 1" - 12" (C style only)

20°F to 300°F (Service Temperature Range)

(-7°C to 149°C)

Recommended for high temperature resistance to oxidizing acids, petroleum oils, hydraulic fluids, halogenated hydrocarbons and lubricants.

Grade "L" Silicone (Red color code)

NOT FOR USE IN DRINKING WATER

Size Range: 1" - 8" (C style only)

-40°F to 350°F (Service Temperature Range)

(-40°C to 177°C)

Recommended for dry, hot air and some high temperature chemical services.

Gasket Type

C Style (1" - 24")

Flush Gap (1" - 24")

Lubrication

Standard

Gruvlok Xtreme (Do Not use for Grade "L")

Rigidlok® Coupling Fig. 7401

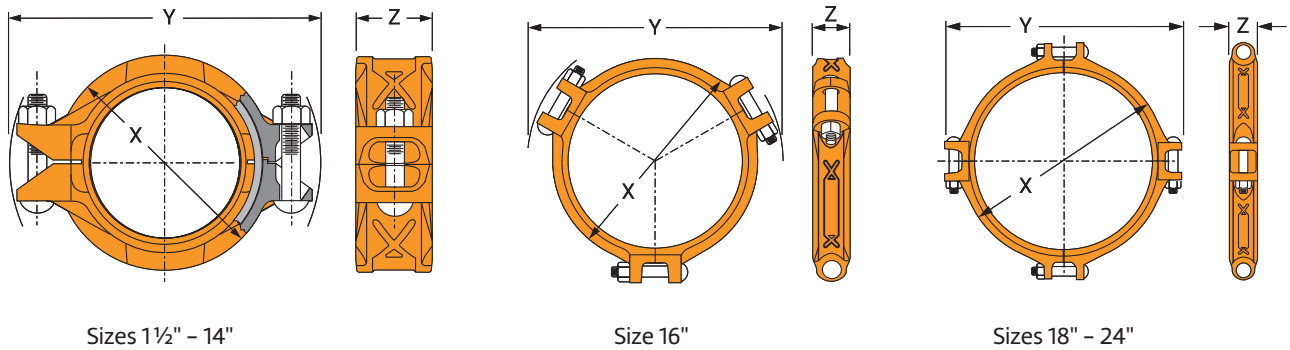

Nominal Size	Pipe O.D.	Max. Working Pressure†	Max. End Load	Allowable Pipe End Separation	Coupling Dimensions			Coupling Bolts		Approx. Wt. Ea.
					X	Y	Z	Qty.	Size	
In./DN(mm)	In./mm	PSI/bar	Lbs./kN	In./mm	In./mm	In./mm	In./mm		In./mm	Lbs./kg
1 1/2 40	1.900 48.3	750 51.7	2,126 9.46	0.13 3.18	3 76	5 1/8 130	1 7/8 48	2	3/8 x 2 1/4 M10 x 57	1.8 0.8
2 50	2.375 60.3	750 51.7	3,323 14.78	0.13 3.18	3 1/2 89	5 5/8 143	1 7/8 48	2	3/8 x 2 1/2 M10 x 63	2.4 1.1
2 1/2 65	2.875 73.0	750 51.7	4,869 21.66	0.13 3.18	4 102	6 1/8 156	1 7/8 48	2	3/8 x 2 1/2 M10 x 63	2.9 1.3
3 O.D. 76.1	2.996 76.1	750 51.7	5,207 23.52	0.13 3.18	4 1/8 105	6 1/8 156	1 7/8 48	2	3/8 x 2 1/2 M10 x 63	3.4 1.5
3 80	3.500 88.9	750 51.7	7,216 32.10	0.13 3.18	4 3/4 121	7 1/4 184	1 7/8 48	2	1/2 x 3 M12 x 76	3.6 1.6
4 100	4.500 114.3	750 51.7	11,928 53.06	0.20 5.08	5 7/8 149	8 3/8 213	2 1/8 54	2	1/2 x 3 M12 x 76	5.0 2.3
5 125	5.563 141.3	750 51.7	18,229 81.09	0.20 5.08	7 178	10 254	2 1/8 54	2	5/8 x 3 1/2 M16 x 85	6.9 3.1
6 1/2 O.D. 165.1	6.500 165.1	750 51.7	24,887 110.70	0.20 5.08	8 203	11 279	2 1/8 54	2	5/8 x 3 1/2 M16 x 85	7.6 3.4
6 150	6.625 168.3	750 51.7	25,854 115.00	0.20 5.08	8 1/8 206	11 1/8 283	2 1/8 54	2	5/8 x 3 1/2 M16 x 85	7.9 3.6

Notes:

Range of Pipe End Separation values are for roll grooved pipe and may be doubled for cut groove pipe.

† Maximum Working Pressure Rating is for schedule 40 steel pipe. For light wall, stainless steel, aluminum and ISO pipe pressure ratings, please refer to the technical data section.

For additional details see "Coupling Data Chart Notes" in the Introduction Section of the Gruvlok Catalog.
See Installation & Assembly directions in the Technical Data Section of the Gruvlok Catalog.

Rigidlok® Coupling Fig. 7401

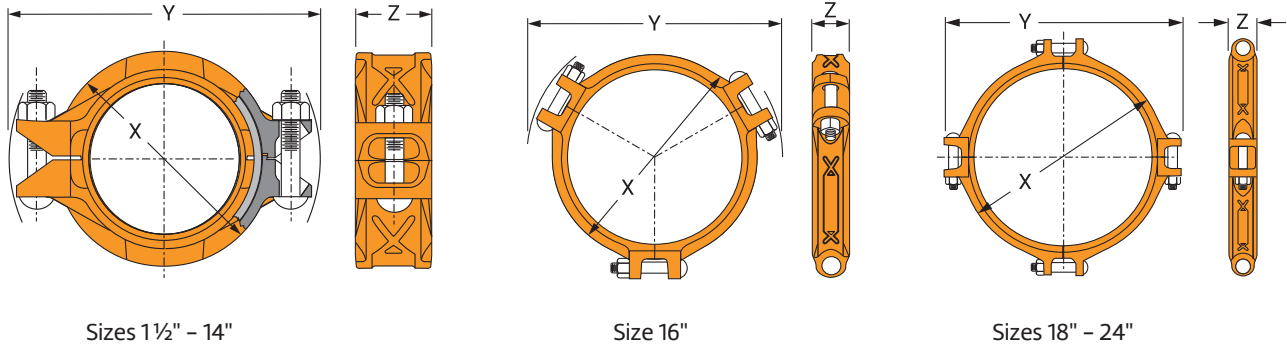

Nominal Size	Pipe O.D.	Max. Working Pressure†	Max. End Load	Allowable Pipe End Separation	Coupling Dimensions			Coupling Bolts		Approx. Wt. Ea.
					X	Y	Z	Qty.	Size	
In./DN(mm)	In./mm	PSI/bar	Lbs./kN	In./mm	In./mm	In./mm	In./mm		In./mm	Lbs./kg
8	8.625	600	35,056	0.20	10½	14⅞	2⅝	2	¾ x 4½	15.9
200	219.1	41.4	155.94	5.08	267	359	67		M20 x 110	7.2
10	10.750	500	45,381	0.20	12⅞	17½	2⅝	2	1 x 6	25.6
250	273.1	34.5	201.87	5.08	327	445	67		M24 x 150	11.6
12	12.750	400	51,070	0.20	15	19½	2⅝	2	⅞ x 6	30.5
300	323.9	27.6	227.17	5.08	381	495	67		M22 x 150	13.8
14	14.000	300	46,181	0.20	16¼	19¾	3	2	⅞ x 5½	36.1
350	355.6	20.7	205.43	5.08	413	502	76		M22 x 140	16.4
16	16.000	300	60,319	0.20	18⅞	22¼	3	3	⅞ x 5½	42.0
400	406.4	20.7	268.31	5.08	460	565	76		M22 x 140	19.1
18	18.000	300	76,341	0.20	20½	24⅜	3⅞	4	1 x 4	51.6
450	457.2	20.7	339.58	5.08	521	619	79		M24 x 100	23.4
20	20.000	300	94,248	0.20	23	26⅞	3⅞	4	1 x 4	68.3
500	508.0	20.7	419.23	5.08	581	683	79		M24 x 100	31.0
24	24.000	250	113,097	0.20	27⅞	30⅞	3⅞	4	1 x 4	89.3
600	609.6	17.2	503.08	5.08	689	784	79		M24 x 100	40.5

Notes:

Range of Pipe End Separation values are for roll grooved pipe and may be doubled for cut groove pipe.

† Maximum Working Pressure Rating is for schedule 40 steel pipe. For light wall, stainless steel, aluminum and ISO pipe pressure ratings, please refer to the technical data section.

For additional details see "Coupling Data Chart Notes" in the Introduction Section of the Gruvlok Catalog.

See Installation & Assembly directions in the Technical Data Section of the Gruvlok Catalog.

Rigidlok® Coupling
Fig. 7401-2



Gruvlok introduces new 2-piece large diameter standard groove couplings in both rigid and flexible styles

- Uses standard grooves (conforming to AWWA C-606)
- No special grooves or grooving tools needed
- Pressures to 350 P.S.I. on cut or roll grooved pipe with a wall thickness of 0.250" or greater
- No special fittings needed
- No special valves needed
- Up to 23% less weight than competitive models
- Sizes: 14" through 24" in Rigid: Figure 7401-2

Material Specifications

Bolts

SAE J429, Grade 5, Zinc Electroplated

Heavy Hex Nuts

ASTM A563, Grade A, Zinc Electroplated

Stainless Steel Bolts & Nuts

304SS bolts and nuts are available as a standard option. (316SS are available for special order).

Housing

Ductile Iron conforming to ASTM A 536, Grade 65-45-12

Coatings

- Rust inhibiting paint – Color: ORANGE (standard)
- Hot Dipped Zinc Galvanized (optional)
- Other Colors Available (IE: RAL3000 and RAL9000)

For other Coating requirements contact an ASC Engineered Solutions™ Representative.

Gasket Materials

Properties as designated in accordance with ASTM D 2000

Grade "E" EPDM (Green color code)

-40°F to 230°F (Service Temperature Range)
(-40°C to 110°C)

Recommended for water service, diluted acids, alkalies solutions, oil-free air and many other chemical services.

NOT FOR USE IN PETROLEUM APPLICATIONS.

Grade "T" Nitrile (Orange color code)

-20°F to 180°F (Service Temperature Range)
(-29°C to 82°C)

Recommended for petroleum applications. Air with oil vapors and vegetable and mineral oils.

NOT FOR USE IN HOT WATER OR HOT AIR.

Gasket Type

Flush Gap (Standard)

Lubrication

- Standard
- Gruvlok Xtreme

Working Pressure, End Load & Pipe End Separation

Based on standard wall steel pipe with cut or roll grooves in accordance with Gruvlok specifications. See technical data section for design factors.

Rigidlok® Coupling Fig. 7401-2

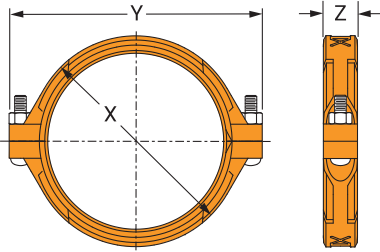

Nominal Size	O.D.	Max. Working Pressure	Max. End Load	Range of Pipe End Separation	Coupling Dimensions			Coupling Bolts*		Specified Torque§		Approx. Wt. Ea.
					X	Y	Z	Qty.	Size	Min.	Max.	
In./DN(mm)	In./mm	PSI/bar	Lbs./kN	In./mm	In./mm	In./mm	In./mm	In./mm		Ft.-Lbs/N-m	Lbs./kg	
14	14	350	53,878	0- ³ / ₃₂	16 ¹ / ₄	19 ³ / ₄	3	2	7/8 x 5 ¹ / ₂	180	220	36.5
350	355.6	24.1	239.66	0-2.38	413	502	76			—	245	300
16	16	350	70,372	0- ³ / ₃₂	18 ⁵ / ₁₆	22	3	2	1 x 5 ¹ / ₂	250	300	46.0
400	406.4	24.1	313.03	0-2.38	465	558	76			—	340	408
18	18	350	89,064	0- ³ / ₃₂	20 ³ / ₄	24 ¹ / ₄	3 ¹ / ₈	2	1 x 5 ¹ / ₂	250	300	62.5
450	457.2	24.1	396.18	0-2.38	527	615	79			—	340	408
20	20	350	109,956	0- ³ / ₃₂	23	27 ¹ / ₈	3 ¹ / ₈	2	1 ¹ / ₈ x 5 ¹ / ₂	375	425	73.5
500	508.0	24.1	489.11	0-2.38	582	691	79			—	510	578
24	24	350	158,336	0- ³ / ₃₂	27 ¹ / ₄	31 ¹ / ₈	3 ³ / ₁₆	2	1 ¹ / ₈ x 5 ¹ / ₂	375	425	90.5
600	609.6	24.1	704.31	0-2.38	688	791	81			—	510	578

Note:

Range of Pipe End Separation values are for roll grooved pipe and may be doubled for cut groove pipe. See Installation & Assembly directions in the Technical Data Section of the Gruvlok Catalog.

SlideLOK® Ready for Installation Coupling
Fig. 74



*Patented



The SlideLOK coupling is the most rigid ready for installation coupling designed to reduce installation time. The slide action eases assembly and reduces installation time. The patented gasket provides four separate sealing surfaces for added protection.

The SlideLOK coupling is designed to be used with roll groove or cut groove steel pipe, grooved light wall pipe, Gruvlok grooved-end fittings, and valves.

The SlideLOK coupling allows for pressures between full vacuum and 750 psi on roll or cut grooved carbon steel standard wall pipe. The SlideLOK coupling provides a rigid connection allowing pipe hanging practices per ASME B31 Pipe Codes.

*Patents: 8550502, 8615865, 2732427, D680629, D680630, D696751, 8282136, 9239123, 9297482, 9194516, 9297484, 9039046, 9500307

Material Specifications

Bolts

SAE J429, Grade 5, Zinc Electroplated

Heavy Hex Nuts

ASTM A563, Grade A, Zinc Electroplated

Hardware Kits

304 Stainless Steel (available in sizes up to ¾")
Kit includes:

- (2) Bolts per ASTM A193, Grade B8 and
- (2) Heavy Hex Nuts per ASTM A194, Grade 8.

EcoGuard® (available in sizes up to ¾")
Kit includes:

- Bolts per SAE J429, Grade 5, with EcoGuard corrosion-resistant zinc flake coating and
- (2) Heavy Hex Nuts per ASTM A563, Grade A, EcoGuard corrosion-resistant zinc flake coating.

Housing

Ductile Iron conforming to ASTM A 536, Grade 65-45-12

Coatings

Rust inhibiting paint
Color: Orange (standard)
Hot Dipped Zinc Galvanized (optional)

Gaskets

Properties as designated in accordance with ASTM D2000

Grade "EP" EPDM (Green and Red color code)
-40°F to 250°F (Service Temperature Range)
(-40°C to 121°C)

Recommended for water service, diluted acids, alkalis solutions, oil-free air and many other chemical services.

NOT FOR USE IN PETROLEUM APPLICATIONS.

Grade "T" Nitrile (Orange color code)
-20°F to 180°F (Service Temperature Range)
(-29°C to 82°C)

Recommended for petroleum applications.
Air with oil vapors and vegetable and mineral oils.
NOT FOR USE IN HOT WATER OR HOT AIR
NOT FOR USE IN DRINKING WATER

Gasket Type

SlideLOK (2" - 8")

Lubrication

Standard
Gruvlok Xtreme



SlideLOK Pressure Responsive Gasket



GRUVLOK
An ASC Engineered Solution

SlideLOK® Ready for Installation Coupling Fig. 74

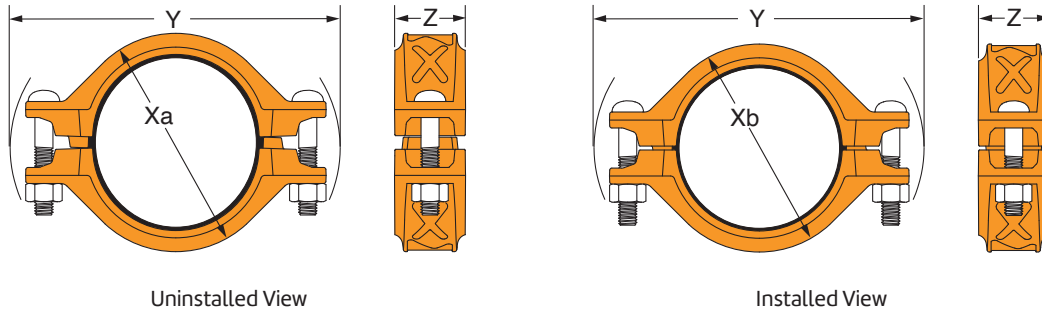

Nominal Size	O.D.	Max. Working Pressure▲	Max. End Load	Allowable Pipe End Separation	Coupling Dimensions				Coupling Bolts		Approx. Wt. Ea.
					Xa	Xb	Y	Z	Qty.	Size	
In./DN(mm)	In./mm	PSI/bar	Lbs./kN	In./mm	In./mm	In./mm	In./mm	In./mm		In./mm	Lbs./kg
2	2.375	750	3,323	0.13	3 ³ / ₄	3 ³ / ₈	6	2	2	1/2 x 2 ³ / ₄	2.9
50	60.3	51.7	14.78	3.18	95	86	152	51		M12 x 70	1.3
2½	2.875	750	4,869	0.13	4 ⁵ / ₈	4¼	6 ³ / ₈	2	2	1/2 x 2 ³ / ₄	3.1
65	73.0	51.7	21.66	3.18	117	108	163	51		M12 x 70	1.4
3	3.500	750	7,216	0.13	5 ¹ / ₆	4 ¹¹ / ₁₆	7	2	2	1/2 x 3½	3.6
80	88.9	51.7	32.10	3.18	132	119	178	51		M12 x 89	1.6
4	4.500	750	11,928	0.20	6½	6	8 ⁵ / ₁₆	2	2	1/2 x 3½	4.9
100	114.3	51.7	53.06	5.08	165	152	212	51		M12 x 89	2.2
5	5.563	750	18,229	0.20	7¼	6¾	10½	2	2	5/8 x 3½	5.5
125	141.3	51.7	81.09	5.08	184	171	267	51		M16 x 89	2.5
6	6.625	700	24,130	0.20	8 ⁵ / ₁₆	7¾	11	2	2	5/8 x 3½	6.3
150	168.3	48.3	107.34	5.08	211	197	279	51		M16 x 89	2.9
8	8.625	600	35,056	0.20	10¾	10 ¹ / ₈	14	2½	2	¾ x 4½	14.3
200	219.1	41.4	155.94	5.08	273	273	356	64		M20 x 115	6.5

Notes:

Allowable Range of Pipe End Separation values are for system layout reference only. Actual installation spacing may vary based on pipe condition.

▲ - Maximum Working Pressure Rating is for schedule 40 steel pipe. For light wall, stainless steel, aluminum and ISO pipe pressure ratings, please refer to the technical data section.

Not for use on "EG" rolled or cut grooved pipe ends.

For additional details see "Coupling Data Chart Notes" in the Introduction Section of the Gruvlok Catalog.

See Installation & Assembly directions in the Technical Data Section of the Gruvlok Catalog.

Not for use in copper systems.

SlideFLEX™ Ready for Installation Flexible Coupling Fig. 70



The SlideFLEX Fig 70 coupling is a flexible ready for installation coupling designed to ease assembly and reduce installation time. The patented gasket provides four separate sealing surfaces for added protection.

The SlideFLEX coupling is designed to be used with roll groove or cut groove steel pipe, Gruvlok grooved-end fittings, and valves.

The SlideFLEX coupling allows for pressures between full vacuum and up to 1,000 psi on roll or cut grooved carbon steel standard wall pipe.

The SlideFLEX coupling provides a flexible connection, allowing linear and angular deflection and standard pipe hanging practices per B31 Pipe Codes.

For Listings/Approval Details and Limitations, visit our website at www.asc-es.com or contact an ASC Engineered Solutions™ Sales Representative.

Material Specifications

Bolts

SAE J429, Grade 5, Ecoguard®
Corrosion-Resistant Zinc-Flake Coating

Heavy Hex Nuts

ASTM A563, Grade A, Ecoguard®
Corrosion-Resistant Zinc-Flake Coating

Housing

Ductile Iron conforming to ASTM A536, Grade 65-45-12

Coatings

Rust inhibiting paint Color: Orange (standard)
Hot Dipped Zinc Galvanized (optional)

Gaskets

Properties as designated in accordance with ASTM D2000

Grade "EP" EPDM (Green and Red color code)
-40°F to 250°F (Service Temperature Range)
(-40°C to 121°C)

Recommended for water service, diluted acids, alkalis solutions, oil-free air and many other chemical services.

NOT FOR USE IN PETROLEUM APPLICATIONS.

Grade "T" Nitrile (Orange color code)
-20°F to 180°F (Service Temperature Range)
(-29°C to 82°C)

Recommended for petroleum applications. Air with oil vapors and vegetable and mineral oils.
NOT FOR USE IN HOT WATER OR HOT AIR.
NOT FOR USE IN DRINKING WATER.

Gasket Type

SlideLOK (2" - 8")

Lubrication

Standard
Gruvlok Xtreme

Working Pressure, End Load, Pipe End Separation & Deflection from Center Line

Based on standard wall steel pipe with cut or roll grooves in accordance with Gruvlok specifications. See technical data section for design factors.



SlideLOK Pressure Responsive Gasket

- Introduction
- Couplings
- Outlets
- Fittings
- Valves & Accessories
- High Pressure
- CTS Copper System
- DI-Electric Nipples
- Plain-End Fittings
- HDPE Couplings
- Socket-It® Fittings
- Stainless Steel Method
- Roll Groovers
- Installation & Assembly
- Special Coatings
- Design Services
- Technical Data
- Master Format 3 Part Specs.
- Pictorial Index

SlideFLEX™ Ready for Installation Flexible Coupling Fig. 70

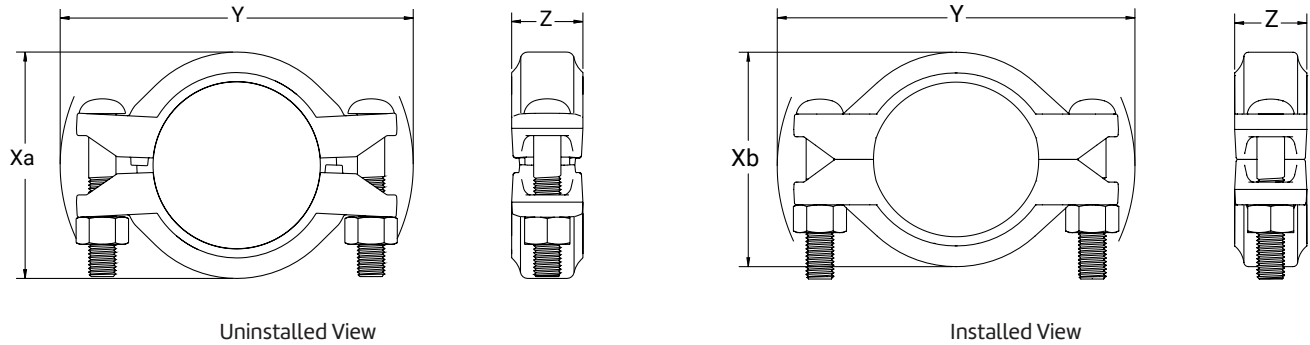

Nominal Size	O.D.	Max. Working Pressure ▲	Max. End Load	Nominal Range of Pipe End Separation	Deflection from C_L		Coupling Dimensions				Bolt Dimensions*		Approx. Wt. Ea.
					Angular	Linear	Xa	Xb	Y	Z	Qty.	Size	
In./DN(mm)	In./mm	PSI/bar	Lbs./kN	In./mm	Degrees	In./ft-mm/m	In./mm	In./mm	In./mm	In./mm		In./mm	Lbs./kg
2	2.375	1000	4,430	0 - 0.13	1.50	0.31	3.97	3.70	6.71	1.78	2	5/8 x 3 1/4	3.77
50	60.3	68.9	19.71	0 - 3.18		In./ft-mm/m	100.8	94	170.4	45.2		N/A	1.71
2 1/2	2.875	1000	6,492	0 - 0.13	1.23	0.26	4.54	4.31	7.15	1.78	2	5/8 x 3 1/4	4.15
65	73.0	68.9	28.88	0 - 3.18		In./ft-mm/m	115.3	109.5	181.6	45.2		N/A	1.88
3	3.5	1000	9,621	0 - 0.13	1.03	0.21	5.18	4.72	8.05	1.81	2	5/8 x 4	5.28
80	88.9	68.9	42.8	0 - 3.18		In./ft-mm/m	17.8	131.6	119.9	204.5		46.0	N/A
4	4.5	1000	15,904	0 - 0.25	1.60	0.33	6.25	6.00	9.21	1.96	2	3/4 x 4 1/2	6.85
100	114.3	68.9	70.75	0 - 6.35		In./ft-mm/m	27.7	158.8	152.4	233.9		49.8	N/A
6	6.625	1000	34,472	0 - 0.25	1.09	0.23	8.62	8.18	12.72	2.11	2	7/8 x 5	12.66
150	168.3	68.9	153.34	0 - 6.35		In./ft-mm/m	18.8	218.95	207.77	323.09		53.59	N/A
8	8.625	800	46,741	0 - 0.25	0.82	0.17	11.02	10.5	15.51	2.5	2	1 x 5 1/2	21.48
200	219.1	55.2	207.91	0 - 6.35		In./ft-mm/m	14.5	279.91	266.70	393.95		63.50	N/A

Notes:

Range of Pipe End Separation values are for system layout reference only. Actual installation spacing may vary based on pipe condition.

▲ Maximum Working Pressure Rating is for schedule 40 steel pipe. For light wall, stainless steel, aluminum and ISO pipe pressure ratings, please refer to the technical data section.
Not for use on "EG" rolled or cut grooved pipe ends.

For additional details see "Coupling Data Chart Notes" in the Introduction Section of the Gruvlok Catalog.
See Installation & Assembly directions in the Technical Data Section of the Gruvlok Catalog.
Not for use in copper systems.

Flexible Coupling Fig. 7001

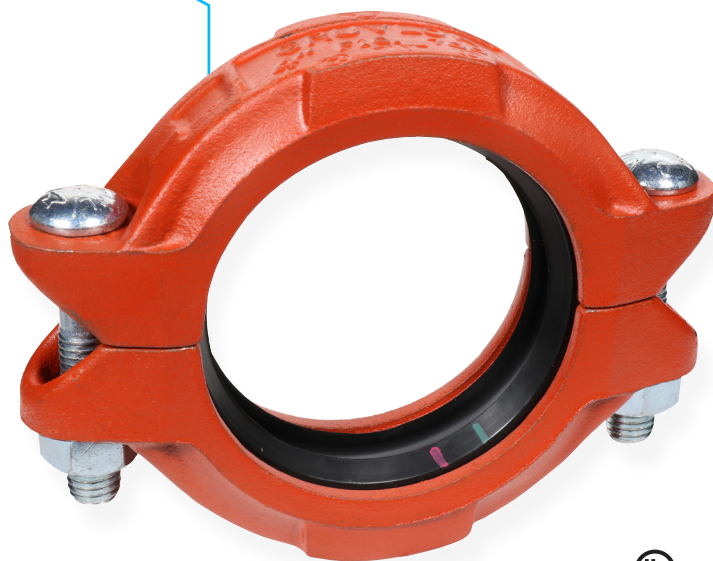

The Gruvlok Fig. 7001 Coupling forms a flexible grooved end pipe joint connection with the versatility for a wide range of applications. Services include mechanical and plumbing, process piping, mining and oil field piping, and many others. The coupling design supplies optimum strength for working pressures to 1000 PSL (69 bar) without excessive casting weight.

The flexible design eases pipe and equipment installation while providing the designed-in benefit of reducing pipeline noise and vibration transmission without the addition of special components. To ease coupling handling and assembly and to assure consistent quality, sizes 1" through 14" couplings have two 180° segment housings, 16" have three 120° segment housings, and 18" through 24" sizes have four 90° segment housings, while the 28" O.D. and 30" O.D. couplings have six 60° segment housings. The 28" O.D. and 30" O.D. are weld-ring couplings.

For Listings/Approval Details and Limitations, visit our website at www.asc-es.com or contact an ASC Engineered Solutions™ Sales Representative.

Material Specifications

Bolts

SAE J429, Grade 5, Zinc Electroplated
ISO 898-1, Class 8.8, Zinc Electroplated
followed by a Yellow Chromate Dip

Heavy Hex Nuts

ASTM A563, Grade A, Zinc Electroplated
ISO 898-2, Class 8.8, Zinc Electroplated
followed by a Yellow Chromate Dip

Hardware Kits

304 Stainless Steel (available in sizes up to ¾")
Kit includes:

- (2) Bolts per ASTM A193, Grade B8
- (2) Heavy Hex Nuts per ASTM A194, Grade 8

EcoGuard (available in sizes up to ¾")

Kit includes:

- (2) Bolts per SAE J429, Grade 5, with EcoGuard corrosion-resistant zinc flake coating
- (2) Heavy Hex Nuts per ASTM A563, Grade A, EcoGuard corrosion-resistant zinc flake coating

Material Specifications (Continued)

Housing

Ductile Iron conforming to ASTM A536, Grade 65-45-12

Coatings

- Rust inhibiting paint
- Color: Orange (standard)
- Hot Dipped Zinc Galvanized (optional)

Gaskets

Properties as designated in accordance with ASTM D2000

Grade "EP" EPDM (Green and Red color code)

-40°F to 250°F (Service Temperature Range)
(-40°C to 121°C)

Recommended for water service, diluted acids, alkalis solutions, oil-free air and many other chemical services. NOT FOR USE IN PETROLEUM APPLICATIONS.

For hot water applications the use of Gruvlok Extreme Temperature lubricant is recommended. NSF-61 Certify for cold and hot water applications up through 12".

Grade "T" Nitrile (Orange color code)

-20°F to 180°F (Service Temperature Range)
(-29°C to 82°C)

Recommended for petroleum applications. Air with oil vapors and vegetable and mineral oils.

NOT FOR USE IN HOT WATER OR HOT AIR

Grade "O" Fluoro-Elastomer (Blue color code)

Size Range: 1" - 12" (C style only)
20°F to 300°F (Service Temperature Range)
(-7°C to 149°C)

Recommended for high temperature resistance to oxidizing acids, petroleum oils, hydraulic fluids, halogenated hydrocarbons and lubricants.

Grade "L" Silicone (Red color code)

Size Range: 1" - 12" (C style only)
-40°F to 350°F (Service Temperature Range)
(-40°C to 177°C)

Recommended for dry, hot air and some high temperature chemical services. Contact an ASC Engineered Solutions Representative for availability.

Gasket Type

- C Style (1" - 30")
- Flush Gap (1" - 24")

Lubrication

- Standard
- Gruvlok Xtreme (Do Not use with Grade "L")

Working Pressure, End Load, Pipe End Separation & Deflection from Center Line

Based on standard wall steel pipe with cut or roll grooves in accordance with Gruvlok specifications. See technical data section for design factors.

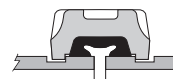

Fig. 7001 with Standard Gap Gasket

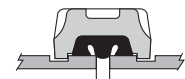
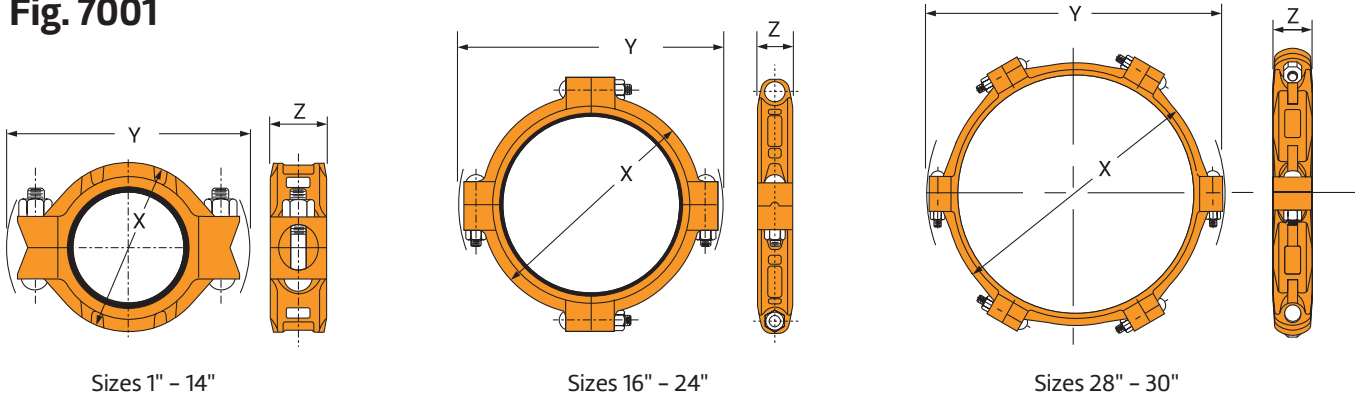

Fig. 7001 with Flush Gap Gasket

Flexible Coupling Fig. 7001



Nominal Size	O.D.	Max. Working Pressure†	Max. End Load	Nominal Range of Pipe End Separation	Deflection from C_L		Coupling Dimensions			Bolt Dimensions*		Specified Torque §		Approx. Wt. Ea.
					Angular	Linear	X	Y	Z	Qty.	Size	Min.	Max.	
In./DN(mm)	In./mm	PSI/bar	Lbs./kN	In./mm	Degrees	In./ft-mm/m	In./mm	In./mm	In./mm		In./mm	ft.-lbs/N-m	ft.-lbs/N-m	Lbs./kg
1 25	1.315 33.4	1000 68.9	1,358 6.04	0 - 0.13 0 - 3.18	2.73	0.57 47.6	2½ 64	4½ 114	1⅞ 48	2	⅜ x 2¼ M10 x 57	30 40	45 60	1.3 0.6
1¼ 32	1.660 42.2	1000 68.9	2,164 9.63	0 - 0.13 0 - 3.18	2.17	0.45 37.6	2¾ 70	4½ 114	1⅞ 48	2	⅜ x 2¼ M10 x 57	30 40	45 60	1.4 0.6
1½ 40	1.900 48.3	1000 68.9	2,835 12.61	0 - 0.13 0 - 3.18	1.90	0.40 33.0	3 76	4⅝ 117	1⅞ 48	2	⅜ x 2¼ M10 x 57	30 40	45 60	1.5 0.7
2 50	2.375 60.3	1000 68.9	4,430 19.71	0 - 0.13 0 - 3.18	1.50	0.31 26.2	3⅝ 92	6⅞ 156	1⅞ 48	2	½ x 3 M12 x 76	80 110	100 150	3.1 1.4
2½ 65	2.875 73.0	1000 68.9	6,492 28.88	0 - 0.13 0 - 3.18	1.23	0.26 21.8	4¼ 108	6½ 165	1⅞ 48	2	½ x 3 M12 x 76	80 110	100 150	3.7 1.7
3 O.D. 76.1	2.996 76.1	1000 68.9	7,050 31.36	0 - 0.13 0 - 3.18	1.20	0.25 20.8	4¼ 108	6¾ 171	1⅞ 48	2	½ x 3 M12 x 76	80 110	100 150	4.3 2.0
3 80	3.500 88.9	1000 68.9	9,621 42.80	0 - 0.13 0 - 3.18	1.03	0.21 17.8	4⅞ 124	7⅞ 181	1⅞ 48	2	½ x 3 M12 x 76	80 110	100 150	4.3 2.0
3½ 90	4.000 101.6	1000 68.9	12,566 55.90	0 - 0.13 0 - 3.18	0.90	0.19 15.6	5¼ 133	8¼ 210	1⅞ 48	2	⅝ x 3½ M16 x 89	100 135	130 175	5.1 2.3
4 100	4.500 114.3	1000 68.9	15,904 70.75	0 - 0.25 0 - 6.35	1.60	0.33 27.7	6¼ 159	8¾ 222	2 51	2	⅝ x 3½ M16 x 89	100 135	130 175	6.8 3.1
5 125	5.563 141.3	1000 68.9	24,306 108.12	0 - 0.25 0 - 6.35	1.29	0.27 22.4	7¼ 184	11¼ 286	2 51	2	¾ x 4½ M20 x 110	130 175	180 245	9.6 4.4
6½ O.D. 165.1	6.500 165.1	1000 68.9	33,183 147.61	0 - 0.25 0 - 6.35	1.11	0.23 19.2	8¼ 210	11¾ 298	2 51	2	¾ x 4½ M20 x 110	130 175	180 245	11.8 5.4

Notes:

Range of Pipe End Separation and Angular Deflection values are for roll grooved pipe and may be doubled for cut groove pipe.

See the Technical Data Section of the Gruvlok Catalog.

For Misalignment, Deflection and Curve Layout Calculations, refer to the Technical Data Section of the Gruvlok Catalog.

† Maximum Working Pressure Rating is for schedule 40 steel pipe. For light wall, stainless steel, aluminum and ISO pipe pressure ratings, please refer to the technical data section.

For additional details see "Coupling Data Chart Notes" in the Introduction Section of the Gruvlok Catalog.

*Available in ANSI or metric bolt sizes only as indicated.

§ - For additional Bolt Torque information, see the Technical Data Section of the Gruvlok Catalog.

See Installation & Assembly directions in the Technical Data Section of the Gruvlok Catalog.

Not for use in copper systems.

Flexible Coupling Fig. 7001

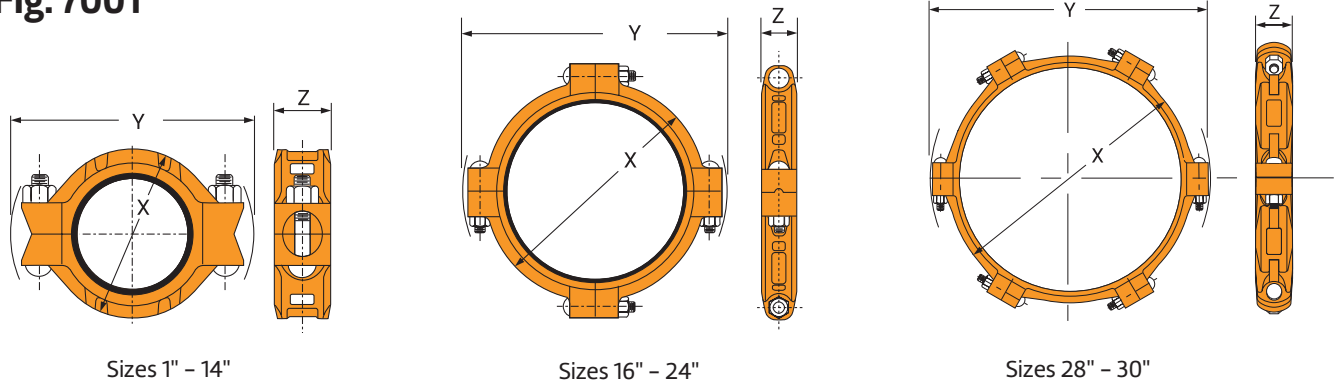

Nominal Size	O.D.	Max. Working Pressure †	Max. End Load	Nominal Range of Pipe End Separation	Deflection from C _L		Coupling Dimensions			Bolt Dimensions*		Specified Torque §		Approx. Wt. Ea.
					Angular	Linear	X	Y	Z	Qty.	Size	Min.	Max.	
In./DN(mm)	In./mm	PSI/bar	Lbs./kN	In./mm	Degrees	In./Ft-mm/m	In./mm	In./mm	In./mm		In./mm	Ft.-Lbs/N-m	Ft.-Lbs/N-m	Lbs./kg
6 150	6.625 168.3	1000 68.9	34,472 153.34	0 - 0.25 0 - 6.35	1.09	0.23 18.8	8 5/8 219	11 3/4 298	2 51	2	3/4 x 4 1/2 M20 x 110	130 175	180 245	11.8 5.4
8 200	8.625 219.1	800 55.2	46,741 207.91	0 - 0.25 0 - 6.35	0.82	0.17 14.5	11 279	14 3/8 365	2 3/8 60	2	7/8 x 5 1/2 M22 x 140	180 245	220 300	21.7 9.8
10 250	10.750 273.0	800 55.2	72,610 322.99	0 - 0.25 0 - 6.35	0.67	0.14 11.6	13 1/8 333	16 5/8 422	2 5/8 67	2	7/8 x 5 1/2 M22 x 140	180 245	220 300	27.0 12.2
12 300	12.750 323.9	800 55.2	102,141 454.35	0 - 0.25 0 - 6.35	0.56	0.12 9.7	15 1/2 394	18 5/8 473	2 5/8 67	2	7/8 x 6 M22 x 150	180 245	220 300	35.0 15.9
14 350	14.000 355.6	300 20.7	46,181 205.43	0 - 0.25 0 - 6.35	0.51	0.11 8.9	16 1/8 410	20 1/2 521	3 76	2	7/8 x 5 1/2 M22 x 140	180 245	220 300	37.0 16.8
16 400	16.000 406.4	300 20.7	60,319 268.31	0 - 0.25 0 - 6.35	0.44	0.09 7.9	18 1/8 460	22 7/8 581	3 76	4	1 x 4 *	200 -	250 -	50.0 22.7
18 450	18.000 457.2	300 20.7	76,341 339.58	0 - 0.25 0 - 6.35	0.40	0.08 6.9	21 1/8 537	25 3/8 645	3 1/8 79	4	1 x 4 *	200 -	250 -	72.0 32.7
20 500	20.000 508.0	300 20.7	94,248 419.23	0 - 0.25 0 - 6.35	0.36	0.08 6.3	23 584	28 1/4 718	3 1/8 79	4	1 1/8 x 4 1/2 *	225 -	275 -	82.0 37.2
24 600	24.000 609.6	300 20.7	135,717 603.70	0 - 0.25 0 - 6.35	0.29	0.06 5.2	27 686	32 3/8 822	3 1/8 79	4	1 1/8 x 4 1/2 *	225 -	275 -	90.0 40.8
28" I.D. 733.4	28.875 733.4	150 10.3	98,226 436.93	0 - 0.25 0 - 6.35	0.24	0.05 4.3	33 1/2 851	35 1/2 902	3 1/8 79	6	1 x 5 1/2 *	200 -	250 -	105.0 47.6
30" I.D. 787.4	31.00 787.4	150 10.3	113,215 503.61	0 - 0.25 0 - 6.35	0.22	0.05 4.0	33 3/4 857	38 1/4 972	3 5/8 92	6	1 x 5 1/2 *	200 -	250 -	137.0 62.1

Notes:

Range of Pipe End Separation and Angular Deflection values are for roll grooved pipe and may be doubled for cut groove pipe. See the Technical Data Section of the Gruvlok Catalog.
 For Misalignment, Deflection and Curve Layout Calculations, refer to the Technical Data Section of the Gruvlok Catalog.
 † Maximum Working Pressure Rating is for schedule 40 steel pipe. For light wall, stainless steel, aluminum and ISO pipe pressure ratings, please refer to the technical data section.

For additional details see "Coupling Data Chart Notes" in the Introduction Section of the Gruvlok Catalog.

*Available in ANSI or metric bolt sizes only as indicated.

§ - For additional Bolt Torque information, see the Technical Data Section of the Gruvlok Catalog.

See Installation & Assembly directions in the Technical Data Section of the Gruvlok Catalog.

Not for use in copper systems.

Flexible Coupling
Fig. 7001-2



Gruvlok introduces new 2-piece large diameter standard groove couplings in both rigid and flexible styles

- Uses standard grooves (conforming to AWWA C-606)
- No special grooves or grooving tools needed
- Pressures to 350 P.S.I. on cut or roll grooved pipe with a wall thickness of 0.250" or greater
- No special fittings needed
- No special valves needed
- Up to 23% less weight than competitive models
- Sizes: 14" through 24" in Flexible: Figure 7001-2

Material Specifications

Bolts

SAE J429, Grade 5, Zinc Electroplated

Heavy Hex Nuts

ASTM A563, Grade A, Zinc Electroplated

Stainless Steel Bolts & Nuts

304SS bolts and nuts are available as a standard option.

(316SS are available for special order).

Housing

Ductile Iron conforming to ASTM A536, Grade 65-45-12

Coatings

Rust inhibiting paint

Color: Orange (standard)

Hot Dipped Zinc Galvanized (optional)

Other Colors Available
(IE: RAL3000 and RAL9000)

For other Coating requirements contact an ASC Engineered Solutions™ Representative.

Gasket Materials

Properties as designated in accordance with ASTM D2000

Grade "E" EPDM (Green color code)

-40°F to 230°F (Service Temperature Range)
(-40°C to 110°C)

Recommended for water service, diluted acids, alkalis solutions, oil-free air and many other chemical services.

NOT FOR USE IN PETROLEUM APPLICATIONS.

Grade "T" Nitrile (Orange color code)

-20°F to 180°F (Service Temperature Range)
(-29°C to 82°C)

Recommended for petroleum applications. Air with oil vapors and vegetable and mineral oils.

NOT FOR USE IN HOT WATER OR HOT AIR.

Gasket Type

Flush Gap (14" - 24")

Lubrication

Standard

Gruvlok Xtreme

Working Pressure, End Load, Pipe End Separation & Deflection from Center Line

Based on standard wall steel pipe with cut or roll grooves in accordance with Gruvlok specifications. See technical data section for design factors.

Flexible Coupling Fig. 7001-2

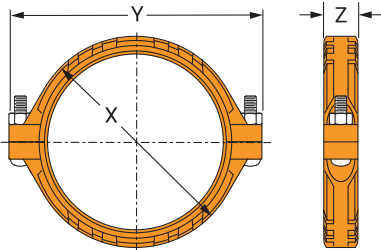

Nominal Size	O.D.	Max. Working Pressure	Max. End Load	Range of Pipe End Separation	Deflection from ζ of Pipe		Coupling Dimensions			Bolt Dimensions*		Specified Torque §		Approx. Wt. Ea.
					Per Coupling	of Pipe	X	Y	Z	Qty.	Size	Min.	Max.	
In./DN(mm)	In./mm	PSI/bar	Lbs./kN	In./mm	Deg(°)-Min(')	In./Ft-mm/m	In./mm	In./mm	In./mm		In./mm	Ft.-Lbs/N-m	Ft.-Lbs/N-m	Lbs./kg
14	14.000	350	53,878	0- ³ / ₃₂	0° 23'	0.08	16 ¹ / ₄	19 ³ / ₄	3	2	7/8 x 5 ¹ / ₂	180	220	36.0
350	355.6	24.1	239.66	0-2.38		6.7	413	502	76		—	245	300	16.3
16	16.000	350	70,372	0- ³ / ₃₂	0° 20'	0.07	18 ⁵ / ₁₆	22	3	2	1 x 5 ¹ / ₂	250	300	45.0
400	406.4	24.1	313.03	0-2.38		5.9	465	558	76		—	340	408	20.4
18	18.000	350	89,064	0- ³ / ₃₂	0° 18'	0.06	20 ³ / ₄	24 ¹ / ₄	3 ¹ / ₈	2	1 x 5 ¹ / ₂	250	300	60.0
450	457.2	24.1	396.18	0-2.38		5.2	527	615	79		—	340	408	27.2
20	20.000	350	109,956	0- ³ / ₃₂	0° 16'	0.06	23	27 ¹ / ₈	3 ¹ / ₈	2	1 ¹ / ₈ x 5 ¹ / ₂	375	425	72.5
500	508.0	24.1	489.11	0-2.38		4.7	582	691	79		—	510	578	32.9
24	24.000	350	158,336	0- ³ / ₃₂	0° 13'	0.05	27 ¹ / ₄	31 ¹ / ₈	3 ³ / ₁₆	2	1 ¹ / ₈ x 5 ¹ / ₂	375	425	90.0
600	609.6	24.1	704.31	0-2.38		3.9	688	791	81		—	510	578	40.8

Notes:

Range of Pipe End Separation and Angular Deflection values are for roll grooved pipe and may be doubled for cut groove pipe.

- Introduction
- Couplings
- Outlets
- Fittings
- Valves & Accessories
- High Pressure
- CTS Copper System
- DI-Electric Nipples
- Plain-End Fittings
- HDPE Couplings
- Socket-It® Fittings
- Stainless Steel Method
- Roll Groovers
- Installation & Assembly
- Special Coatings
- Design Services
- Technical Data
- Master Format 3 Part Specs.
- Pictorial Index

Standard Coupling Fig. 7011

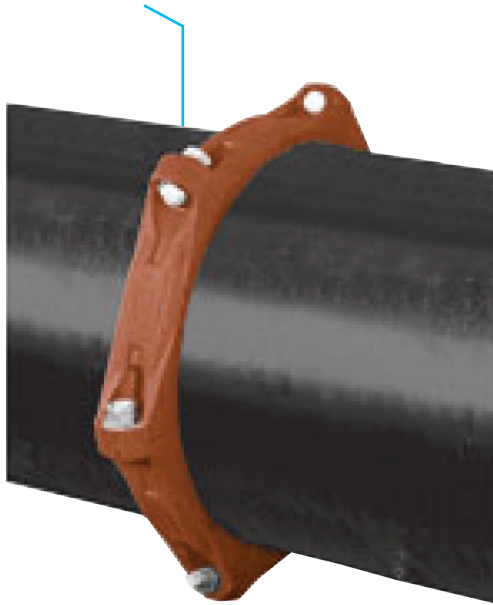

The Gruvlok Figure 7011 Standard Coupling is a flexible coupling designed to join roll grooved or cut grooved 30" O.D. pipe for a wide range of applications, including Commercial/Industrial Construction, Mining, Process Piping and many others. This coupling's operating temperature ranges from -40°F to 230°F (-40°C to 110°C) with the Grade E EPDM gasket and -20°F to 180°F (-29°C to 82°C) with the Grade T Nitrile gasket. The operating pressure ranges 15" of Hg. vacuum to 300 psig on standard wall steel pipe.

Material Specifications

Housing Design

This six-segment coupling housing is cast in ductile iron per ASTM A 536 Grade 65-45-12. Each housing segment is machined to assure a close dimensional fit with pipe ends that are prepared in accordance with Gruvlok "Large Diameter Roll and Cut Groove Specifications."

Gasket Design

The gasket design is a "C" Style cross section and features a larger cross section to provide optimal sealing throughout the range of pipe dimensional variations and operating conditions. The gasket is available in EPDM and Nitrile, to facilitate use in a wide range of applications. For Gruvlok gasket material recommendations see the Gruvlok catalog.

Bolts

SAE J429, Grade 5, Zinc Electroplated

Heavy Hex Nuts

ASTM A563, Grade A, Zinc Electroplated

Pipe End Preparation

Pipe grooving is simple, easy and quick. It is critical that the pipe ends be prepared in accordance with the Gruvlok "Large Diameter Roll and Cut Groove Specifications."

For roll grooved pipe, grinding the weld seam on the interior and exterior of the pipe may be required. Not performing this operation may result in improper assembly of the coupling, gasket leakage and damage to the roll grooving machine.

Standard Coupling Fig. 7011

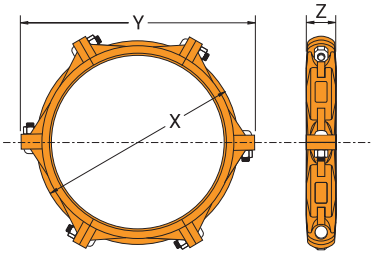

Nominal Size	O.D.	Max. Working Pressure	Max. End Load	Range of Pipe End Separation	Deflection from ϕ of Pipe		Coupling Dimensions			Coupling Bolts*		Specified Torque §		Approx. Wt. Ea.
					Per Coupling	of Pipe	X	Y	Z	Qty.	Size	Min.	Max.	
In./DN(mm)	In./mm	PSI/bar	Lbs./kN	In./mm	Deg(°)-Min(")	In./ft-mm/m	In./mm	In./mm	In./mm		In./mm	Ft.-Lbs./N-m	Lbs./kg	
30 O.D.	30.000	300	212,058	0- $\frac{9}{64}$	0° 16'	0.06	34	39½	5	6	1¼ X 4¾	600	800	200
750	762.0	20.7	943.2	0-3.57		4.7	864	1003	127					

Note:

Working pressure and end load values are for standard wall pipe. Range of pipe end separation values are for cut grooved pipe. Roll and Cut Grooving Specifications can be found in the technical data section.

For additional details see "Coupling Data Chart Notes" in the Introduction Section of the Gruvlok Catalog.

*Available in ANSI or metric bolt sizes only as indicated.
§ - For additional Bolt Torque information, see the Technical Data Section of the Gruvlok Catalog.

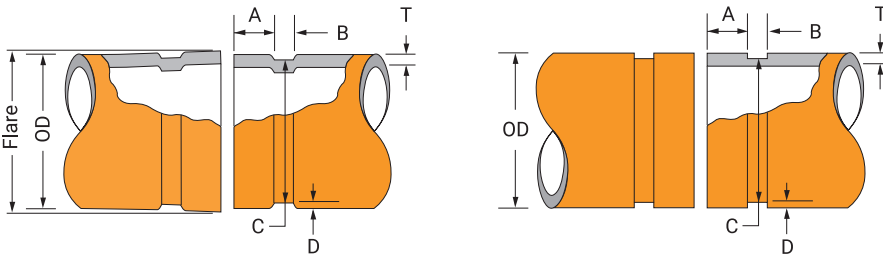

Nominal IPS Pipe Size	O.D.		Gasket Seat "A" +0.030/-0.060 +0.77/-1.54	Groove Width "B" ±0.030 ±.77	Groove Diameter "C"		Groove Depth "D" (Ref. Only) Y	Min. Wall Thickness "T"		Max. Flare Dia.	
	Actual	Tolerance			Actual	Tol +0.000		Roll Groove	Cut Groove		
In./DN(mm)	In./mm	+In./mm	-In./mm	In./mm	In./mm	In./mm	-In./mm	In./mm	In./mm	In./mm	
30 O.D.	30.000	0.093	0.031	1.750	0.625	29.500	0.063	0.250	0.250	0.625	30.200
750.0	762.0	2.36	0.79	44.45	15.88	749.30	1.60	6.35	6.35	15.88	767.1

Note:

Pipe O.D. must be within specified dimensions
Gasket Seat must be free from scores, seams, chips, rust or other scale, which may interfere with proper sealing of the gasket. Gasket Seat width, dimension A, is to be measured from the pipe end to the vertical flank in the groove.
Groove width, dimension B, is to be measured between the vertical flank of the groove side walls.
Groove depth must be uniform depth around the entire pipe circumference. (Reference column 6.)
Maximum Flare Diameter is to be measured at the most extreme pipe end.
Out of Roundness: Difference between the maximum and minimum pipe O.D. measured at 90° must not exceed the total pipe O.D. tolerance listed (Reference column 2).

The maximum allowable tolerance from square cut ends is .125" measured from a true square line.
Beveled end pipe in conformance with ANSI B16.25 (37½°) is acceptable, however square cut is preferred.

Special Roll Grooving Instruction

Weld seams must be ground flush with the pipe O.D. and I.D. prior to roll grooving. Failure to do so may result in damage to the roll grooving machine and unacceptable roll grooves may be produced.

Weld Ring Gruv-Ring® Coupling Fig. 7022

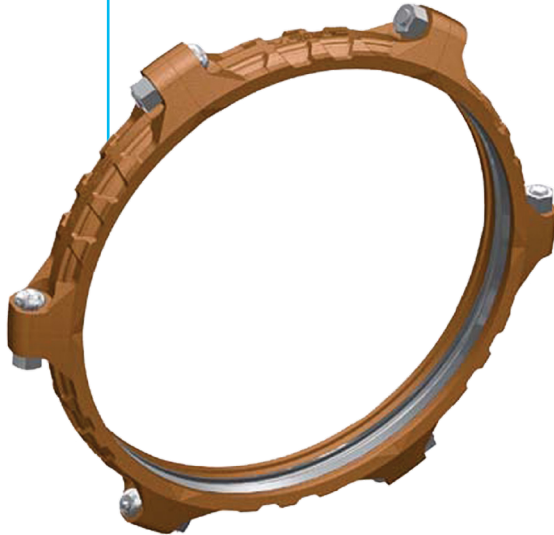

The Gruvlok Figure 7022 coupling with Gruv-Ring forms a flexible grooved end pipe joint for use on steel pipe. Services for this versatile connection include large O.D. mining applications such as process, tailings and slurries. The coupling's multi-segment design supplies optimum strength for working pressures to 175 PSL.

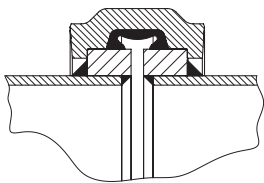

Fig. 7022 with Type C Ring

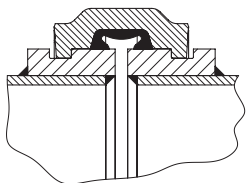

Fig. 7022 with Type D Ring

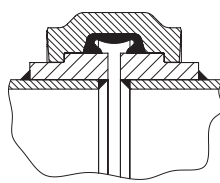

Fig. 7022 with Type E Ring

Material Specifications

Bolts

SAE J429, Grade 5, Zinc Electroplated

Heavy Hex Nuts

ASTM A563, Grade A, Zinc Electroplated

Stainless Steel Bolts & Nuts

304SS bolts and nuts are available as a standard option.

(316SS are available for special order).

Housing

Ductile Iron conforming to ASTM A536, Grade 65-45-12

Coatings

Rust inhibiting paint

Color: Orange (standard)

Hot Dipped Zinc Galvanized (optional)

Other Colors Available

(IE: RAL3000 and RAL9000)

For other Coating requirements contact an ASC Engineered Solutions™ Representative.

Gasket Materials

Properties as designated in accordance with ASTM D2000

Grade "E" EPDM (Green color code)

-40°F to 230°F (Service Temperature Range)

(-40°C to 110°C)

Recommended for water service, diluted acids, alkalies solutions, oil-free air and many other chemical services.

NOT FOR USE IN PETROLEUM APPLICATIONS.

Grade "T" Nitrile (Orange color code)

-20°F to 180°F (Service Temperature Range)

(-29°C to 82°C)

Recommended for petroleum applications, air with oil vapors and vegetable and mineral oils.

NOT FOR USE IN HOT WATER OR HOT AIR

Gasket Type

C Style cross section featuring an enhanced larger cross section to provide optimal sealing throughout the range of pipe dimensional variations and operating conditions.

Lubrication

Standard

Gruvlok Xtreme

Weld Ring Gruv-Ring® Coupling Fig. 7022

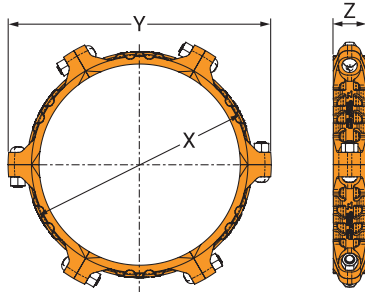

Nominal Size	Pipe O.D. Range		Applied Gruv-Ring O.D.	Max. Working Pressure	Max. End Load	Range of Pipe End Separation	Deflection from ϕ Per Coupling of Pipe		Coupling Dimensions			No. of Segments	Coupling Bolts		Approx. Wt. per Segment	Total Assembly Weight
	In.	In./mm	In./mm	PSI/kPa	Lbs./N	In./mm	Degrees(°)	In./ft-mm/n	X	Y	Z		Qty.	Size		
30	28.00-32.00 711.2-812.8	33.75 857	175 1207	156,558 696,405	0-1/2 0-12.7	0.85	0.18 15.0	37.00 940	43.25 1099	5.375 137	6	6	1 1/2 x 5 3/4	42 19.1	250 113.4	
36	34.00-38.00 863.6-965.2	40.19 1021	175 1207	221,978 987,407	0-1/2 0-12.7	0.72	0.15 12.5	43.47 1104	50.00 12.70	5.375 137	6	6	1 1/2 x 5 3/4	48 21.8	290 131.5	
42	40.00-44.00 1,016.0-1,117.6	46.63 1184	175 1207	298,790 1,329,084	0-1/2 0-12.7	0.62	0.12 10.0	49.84 1266	56.50 1435	5.375 137	8	8	1 3/4 x 6	46 20.8	345 156.5	
48	46.00-50.00 1,168.4-1,270.0	53.13 1350	175 1207	387,905 1,725,488	0-1/2 0-12.7	0.53	0.11 9.2	57.16 1452	62.50 1588	5.500 140	8	16	1 3/8 x 5 3/4	73 32.9	580 263.1	
54	52.00-56.00 1,320.8-1,422.4	59.69 1516	175 1207	489,660 2,178,116	0-1/2 0-12.7	0.48	0.10 8.3	63.60 1615	69.28 1760	5.625 143	8	16	1 1/2 x 5 3/4	81 36.7	650 294.8	
60	58.00-64.00 1,473.2-1,625.6	66.19 1681	175 1207	602,116 2,678,346	0-1/2 0-12.7	0.43	0.09 7.5	70.00 1778	75.71 1923	5.750 146	10	20	1 1/2 x 5 3/4	76 34.3	750 340.2	

Note:

Impact gun can be used for installation, verify that the output of the impact gun is within the required torque range.

For additional details see "Coupling Data Chart Notes" in the Introduction Section of the Gruvlok Catalog.

For additional Bolt Torque information, contact an ASC Engineered Solutions™ Representative.

- Introduction
- Couplings
- Outlets
- Fittings
- Valves & Accessories
- High Pressure
- CTS Copper System
- DI-Electric Nipples
- Plain-End Fittings
- HDPE Couplings
- Socket-It® Fittings
- Stainless Steel Method
- Roll Groovers
- Installation & Assembly
- Special Coatings
- Design Services
- Technical Data
- Master Format 3 Part Specs.
- Pictorial Index

Gruv-Ring® Welded Shoulder Rings For use with **Fig. 7022 Couplings**

Material Specifications

Material

ASTM A105

Additional material options available upon request.

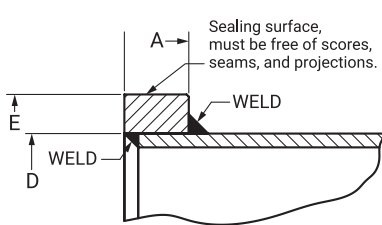

D – Ring I.D. based on Pipe O.D. Dimensions.

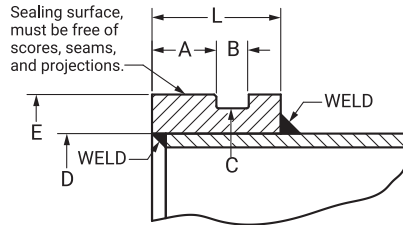

D – Ring I.D. based on Pipe O.D. Dimensions.

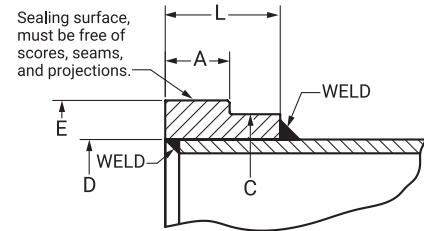

D – Ring I.D. based on Pipe O.D. Dimensions.

Gruv-Ring Type C

Size	Gasket Seat		Ring O.D.
	A	E	
In./mm	In./mm	In./mm	
30	1.75	33.75	
750	44.5	857.3	
36	1.75	40.19	
900	44.5	1020.8	
42	1.75	46.63	
1050	44.5	1184.3	
48	1.75	53.13	
1200	44.5	1349.4	
54	1.75	59.69	
1375	44.5	1516.1	
60	1.75	66.19	
1500	44.5	1681.2	

Gruv-Ring Type D

Size	Gasket Seat	Groove Width	Groove Diameter	Ring O.D.		Ring Width
				E	L	
In./mm	In./mm	In./mm	In./mm	In./mm	In./mm	In./mm
30	1.75	0.88	33.00	33.75	3.50	
750	44.5	22.2	838.2	857.3	88.9	
36	1.75	0.94	39.44	40.19	3.50	
900	44.5	23.8	1001.7	1020.8	88.9	
42	1.75	1.00	45.81	46.63	3.62	
1050	44.5	25.4	1163.6	1184.3	91.9	
48	1.75	1.06	52.19	53.13	3.88	
1200	44.5	27.0	1349.4	1349.4	98.4	
54	1.75	1.13	58.63	59.69	3.88	
1375	44.5	28.6	1489.1	1516.1	98.4	
60	1.75	1.13	65.06	66.19	3.88	
1500	44.5	28.6	1652.6	1681.2	98.4	

Gruv-Ring Type E

Size	Gasket Seat	Groove Diameter	Ring O.D.		Ring Width
			E	L	
In./mm	In./mm	In./mm	In./mm	In./mm	In./mm
30	1.75	33.00	33.75	3.50	
750	44.5	838.2	857.3	88.9	
36	1.75	39.44	40.19	3.50	
900	44.5	1001.7	1020.8	88.9	
42	1.75	45.81	46.63	3.62	
1050	44.5	1163.6	1184.3	91.9	
48	1.75	52.19	53.13	3.88	
1200	44.5	1349.4	1349.4	98.4	
54	1.75	58.63	59.69	3.88	
1375	44.5	1489.1	1516.1	98.4	
60	1.75	65.06	66.19	3.88	
1500	44.5	1652.6	1681.2	98.4	

Note:

Gruv-Rings are not to be considered as pipe reinforcement. Additional provision must be provided by the piping system designer if reinforcement is required.

Gruv-Ring® Welded Shoulder Rings For use with **Fig. 7022 Couplings**

When ordering, please provide the required information below to your ASC Engineered Solutions™ Representative.

JOINT TYPE		
Pipe to Pipe (Two Rings Required)		
Pipe to Shoulder (One Ring Required)		
APPLICATION		
Fluid Media:		
Working Pressure:		
Test Pressure:		
Temperature:	Minimum:	Maximum:
PIPE SPECIFICATION		
Pipe Material:		
Nominal Pipe Size:		
Measured Pipe OD:		
Pipe Schedule:		
Wall Thickness:		
COUPLING CONFIGURATION		
Size:		
Number of Joints:		
Gasket Materials:		
Grade "E" EPDM (Green color code)		
Grade "T" Nitrile (Orange color code)		
Coupling Finish:		
Rust inhibiting paint – Color: Orange (standard)		
Hot Dipped Zinc Galvanized (optional)		
Other Colors Available (IE: RAL3000 and RAL9000)		
LINED PIPE (optional)		
Abrasive		
Corrosive		
Lined Thickness:		
Lined Material:		

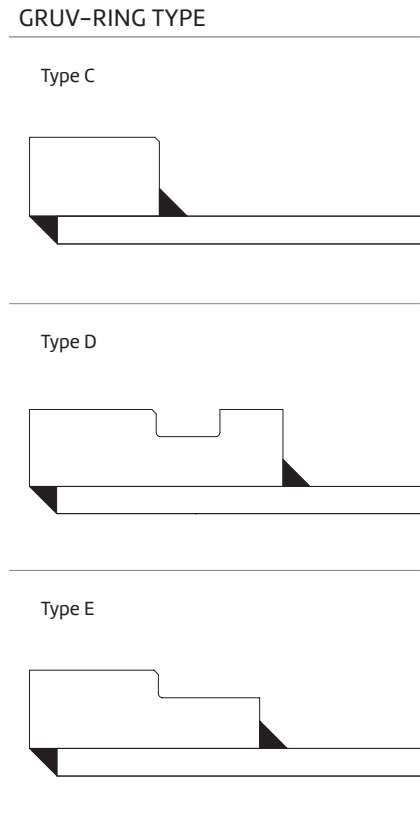

- Introduction
- Couplings**
- Outlets
- Fittings
- Valves & Accessories
- High Pressure
- CTS Copper System
- DI-Electric Nipples
- Plain-End Fittings
- HDPE Couplings
- Socket-Fittings
- Stainless Steel Method
- Roll Groovers
- Installation & Assembly
- Special Coatings
- Design Services
- Technical Data
- Master Format 3 Part Specs.
- Pictorial Index

Lightweight Flexible Coupling Fig. 7000



The Fig. 7000 Lightweight Flexible Coupling is designed for applications where system flexibility is desired.

The Fig. 7000 Coupling is approximately 30% lighter in weight than the Fig. 7001 Coupling, and allows for working pressure ratings up to 600 psi (41.4 bar).

The Figure 7000 Lightweight Flexible Coupling is intended for use in several applications. See gasket Grade Index for gasket recommendations.

See technical data section for design factors.

For Listings/Approval Details and Limitations, visit our website at www.asc-es.com or contact an ASC Engineered Solutions™ Sales Representative.

Material Specifications

Bolts

SAE J429, Grade 5, Zinc Electroplated
ISO 898-1, Class 8.8, Zinc Electroplated
followed by a Yellow Chromate Dip

Heavy Hex Nuts

ASTM A563, Grade A, Zinc Electroplated
ISO 898-2, Class 8.8, Zinc Electroplated
followed by a Yellow Chromate Dip

Hardware Kits

304 Stainless Steel (available in sizes
up to ¾")

Kit includes:

- (2) Bolts per ASTM A193, Grade B8 and
- (2) Heavy Hex Nuts per ASTM A194,
Grade 8.

EcoGuard® (available in sizes up to ¾")

Kit includes:

- Bolts per SAE J429, Grade 5, with
EcoGuard corrosion-resistant zinc flake
coating and
- (2) Heavy Hex Nuts per ASTM A563, Grade
A, EcoGuard corrosion-resistant zinc
flake coating.

Material Specifications (Continued)

Stainless Steel Bolts & Nuts

304SS bolts and nuts are available as a
standard option.

(316SS are available for special order).

Housing

Ductile Iron conforming to ASTM A536,
Grade 65-45-12

Coatings

Rust inhibiting paint

Color: Orange (standard)

Hot Dipped Zinc Galvanized (optional)

Gasket Materials

Properties as designated in accordance with
ASTM D2000

Grade "EP" EPDM (Green and Red color code)

-40°F to 250°F (Service Temperature Range)
(-40°C to 121°C)

Recommended for water service, diluted acids,
alkalies solutions, oil-free air and many other
chemical services.

NOT FOR USE IN PETROLEUM APPLICATIONS.

For hot water applications the use of Gruvlok Extreme
Temperature lubricant is recommended. NSF-61
Certified for cold and hot water applications up through
12".

Grade "T" Nitrile (Orange color code)

20°F to 180°F (Service Temperature Range)
(-29°C to 82°C)

Recommended for petroleum applications. Air with
oil vapors and vegetable and mineral oils.

NOT FOR USE IN HOT WATER OR HOT AIR

Grade "O" Fluoro-Elastomer (Blue color code)

Size Range: 1" - 8" (C style only)

-20°F to 300°F (Service Temperature Range)
(-29°C to 149°C)

Recommended for high temperature resistance
to oxidizing acids, petroleum oils, hydraulic fluids
halogenated hydrocarbons and lubricants.

Grade "L" Silicone (Red color code)

Size Range: 1" - 8" (C style only)

-40°F to 350°F (Service Temperature Range)
(-40°C to 177°C)

Recommended for dry, hot air and some high
temperature chemical services.

Gasket Type

Standard C Style (1" - 8")

Flush Gap (1" - 8")

Lubrication

Standard Gruvlok

Gruvlok Xtreme (Do Not use with Grade "L")

Lightweight Flexible Coupling Fig. 7000

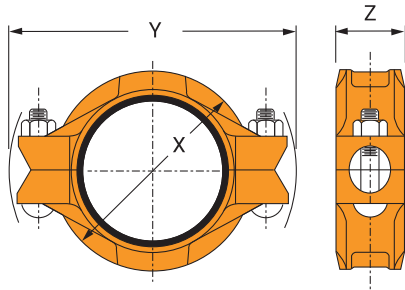

Nominal Size	O.D.	Max. Working Pressure †	Max. End Load	Nominal Range of Pipe End Separation	Deflection from C		Coupling Dimensions			Coupling Bolts		Specified Torque §		Approx. Wt. Ea.
					Angular	Linear	X	Y	Z	Qty.	Size	Min.	Max.	
In./DN(mm)	In./mm	PSI/bar	Lbs./kN	In./mm	Degrees	In./ft-mm/m	In./mm	In./mm	In./mm		In./mm	Ft.-Lbs/N-m	Ft.-Lbs/N-m	Lbs./kg
1	1.315	600	815	0-0.13	2.73	0.57	2 ³ / ₈	4 ¹ / ₄	1 ³ / ₄	2	3 ⁸ / ₁₆ x 2 ¹ / ₄	30	45	1.3
25	33.4	41.4	3.62	0-3.18		47.6	60	108	44		M10 x 57	40	60	0.6
1 ¹ / ₄	1.660	600	1,299	0-0.13	2.17	0.45	2 ³ / ₄	4 ³ / ₈	1 ³ / ₄	2	3 ⁸ / ₁₆ x 2 ¹ / ₄	30	45	1.4
32	42.2	41.4	5.78	0-3.18		37.6	70	111	44		M10 x 57	40	60	0.6
1 ¹ / ₂	1.900	600	1,701	0-0.13	1.90	0.40	3	4 ⁵ / ₈	1 ³ / ₄	2	3 ⁸ / ₁₆ x 2 ¹ / ₄	30	45	1.5
40	48.3	41.4	7.57	0-3.18		33.0	76	117	44		M10 x 57	40	60	0.7
2	2.375	600	2,658	0-0.13	1.50	0.31	3 ¹ / ₂	5 ¹ / ₂	1 ³ / ₄	2	3 ⁸ / ₁₆ x 2 ¹ / ₄	30	45	1.7
50	60.3	41.4	11.82	0-3.18		26.2	89	140	44		M10 x 57	40	60	0.8
2 ¹ / ₂	2.875	600	3,895	0-0.13	1.23	0.26	4	5 ³ / ₄	1 ³ / ₄	2	3 ⁸ / ₁₆ x 2 ¹ / ₄	30	45	1.9
65	73.0	41.4	17.33	0-3.18		21.8	102	146	44		M10 x 57	40	60	0.9
3	3.500	600	5,773	0-0.13	1.03	0.21	4 ⁵ / ₈	6 ³ / ₄	1 ³ / ₄	2	1 ¹ / ₂ x 2 ³ / ₄	80	100	2.9
80	88.9	41.4	25.68	0-3.18		17.8	117	171	44		M12 x 70	110	150	1.3
3 ¹ / ₂	4.000	600	7,540	0-0.13	0.90	0.19	5 ¹ / ₈	7 ⁵ / ₈	1 ³ / ₄	2	1 ¹ / ₂ x 3	80	100	3.1
90	101.6	41.4	33.54	0-3.18		15.6	130	194	44		M12 x 76	110	150	1.4
4	4.500	600	9,543	0-0.25	1.60	0.33	5 ⁷ / ₈	8 ¹ / ₈	2	2	1 ¹ / ₂ x 3	80	100	4.6
100	114.3	41.4	42.45	0-6.35		27.7	149	206	51		M12 x 76	110	150	2.1

Notes:

Range of Pipe End Separation and Angular Deflection values are for roll grooved pipe and may be doubled for cut groove pipe. See the Technical Data Section of the Gruvlok Catalog.

For Misalignment, Deflection and Curve Layout Calculations, refer to the Technical Data Section of the Gruvlok Catalog.

† Maximum Working Pressure Rating is for schedule 40 steel pipe. For light wall, stainless steel, aluminum and ISO pipe pressure ratings, please refer to the technical data section.

For additional details see "Coupling Data Chart Notes" in the Introduction Section of the Gruvlok Catalog.

§ - For additional Bolt Torque information, see the Technical Data Section of the Gruvlok Catalog.

See Installation & Assembly directions in the Technical Data Section of the Gruvlok Catalog.

Not for use in copper systems.

Lightweight Flexible Coupling Fig. 7000

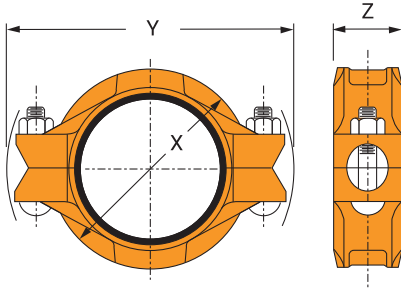

Nominal Size	O.D.	Max. Working Pressure †	Max. End Load	Nominal Range of Pipe End Separation	Deflection from ζ		Coupling Dimensions			Coupling Bolts		Specified Torque §		Approx. Wt. Ea.
					Angular	Linear	X	Y	Z	Qty.	Size	Min.	Max.	
In./DN(mm)	In./mm	PSI/bar	Lbs./kN	In./mm	Degrees	In./ft–mm/m	In./mm	In./mm	In./mm		In./mm	Ft.-Lbs/N-m	Ft.-Lbs/N-m	Lbs./kg
5	5.563	500	12,153	0-0.25	1.29	0.27	7	9 ⁵ / ₈	2	2	5/8 x 3 1/2	100	130	6.1
125	141.3	34.5	54.06	0-6.35		22.4	178	244	51		M16 x 85	135	175	2.8
6	6.625	500	17,236	0-0.25	1.09	0.23	8	11	2	2	5/8 x 3 1/2	100	130	8.1
150	168.3	34.5	76.67	0-6.35		18.8	203	279	51		M16 x 85	135	175	3.7
8	8.625	500	29,213	0-0.25	0.82	0.17	10 1/2	12 ¹³ / ₁₆	2 1/2	2	3/4 x 4 1/2	130	180	14.2
200	219.1	34.5	129.95	0-6.35		14.5	264	337	60		M20 x 110	175	245	6.4

Notes:

Range of Pipe End Separation and Angular Deflection values are for roll grooved pipe and may be doubled for cut groove pipe. See the Technical Data Section of the Gruvlok Catalog.

For Misalignment, Deflection and Curve Layout Calculations, refer to the Technical Data Section of the Gruvlok Catalog.

† Maximum Working Pressure Rating is for schedule 40 steel pipe. For light wall, stainless steel, aluminum and ISO pipe pressure ratings, please refer to the technical data section.

For additional details see "Coupling Data Chart Notes" in the Introduction Section of the Gruvlok Catalog.

§ – For additional Bolt Torque information, see the Technical Data Section of the Gruvlok Catalog.

See Installation & Assembly directions in the Technical Data Section of the Gruvlok Catalog.

Not for use in copper systems.

Rigidlite® Coupling
Fig. 7400

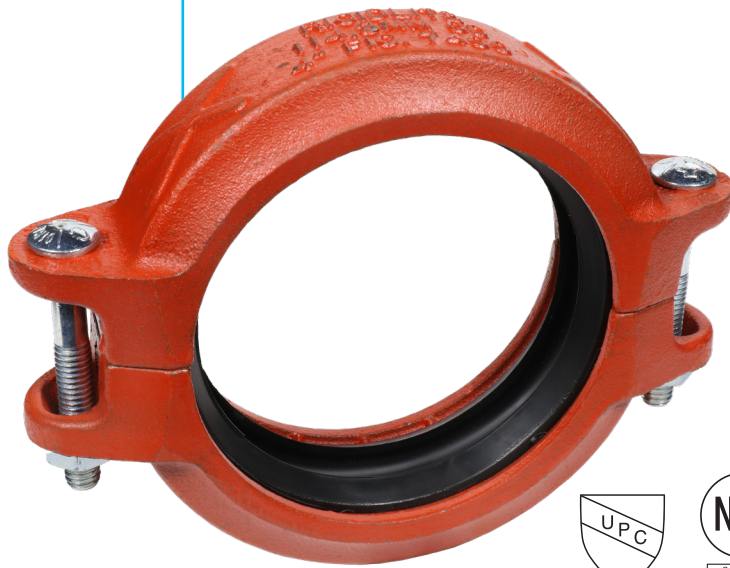

The Fig. 7400 Rigidlite Coupling from Gruvlok is specially designed to provide a rigid, locked-in pipe connection to meet the specific demands rigid design steel pipe systems. Fast and easy swing-over installation of the rugged lightweight housing produces a secure, rigid pipe joint.

The galvanized Fig. 7400 is ideal for stainless steel piping application where the external corrosion properties of stainless steel is not required. For Gruvlok coupling pressure ratings on stainless steel pipe, please refer to the technical data section of the Gruvlok catalog.

Material Specifications

Bolts

SAE J429, Grade 5, Zinc Electroplated (standard)

Heavy Hex Nuts

SAE A563, Grade A, Zinc Electroplated (standard)

Hardware Kits

304 Stainless Steel (available in sizes up to ¾")

Kit includes:

- (2) Bolts per ASTM A193, Grade B8 and
- (2) Heavy Hex Nuts per ASTM A194, Grade 8.

Hardware Kits (Continued)

EcoGuard (available in sizes up to ¾")
Kit includes:

- Bolts per SAE J429, Grade 5, with EcoGuard corrosion-resistant zinc flake coating and
- (2) Heavy Hex Nuts per ASTM A563, Grade A, EcoGuard corrosion-resistant zinc flake coating.

Housing

Ductile Iron conforming to ASTM A536, Grade 65-45-12.

Material Specifications (Continued)

Coatings

- Rust inhibiting paint
- Color: Orange (standard)
- Hot Dipped Zinc Galvanized (optional)

Gaskets

Properties as designated in accordance with ASTM D2000

Grade "EP" EPDM (Green and Red color code)
-40°F to 250°F (Service Temperature Range)
(-40°C to 121°C)

Recommended for water service, diluted acids, alkalis solutions, oil-free air and many other chemical services.

NOT FOR USE IN PETROLEUM APPLICATIONS.

For hot water applications the use of Gruvlok Xtreme Temperature lubricant is recommended. NSF-61 Certified

Grade "T" Nitrile (Orange color code)
NOT FOR USE IN DRINKING WATER

-20°F to 180°F (Service Temperature Range)
(-29°C to 82°C)

Recommended for petroleum applications. Air with oil vapors and vegetable and mineral oils. NOT FOR USE IN HOT WATER OR HOT AIR

Grade "L" Silicone (Red color code)
NOT FOR USE IN DRINKING WATER

Size Range: 1" - 8" (C style only)

-40°F to 350°F (Service Temperature Range)
(-40°C to 177°C)

Recommended for dry, hot air and some high temperature chemical services.

Gasket Type

- Standard C Style (1" - 8")
- Flush Gap (1" - 8")

Lubrication

- Standard Gruvlok
- Gruvlok Xtreme (Do Not use for Grade "L")

Rigidlite® Coupling Fig. 7400

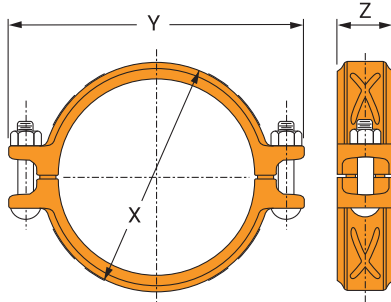

Nominal Size	O.D.	Max. Working Pressure †	Max. End Load	Range of Pipe End Separation	Dimensions			Coupling Bolts		Approx. Wt. Ea.
					X	Y	Z	Qty.	Size	
In./DN(mm)	In./mm	PSI/bar	Lbs./kN	In./mm	In./mm	In./mm	In./mm	In./mm	Lbs./kg	
1 25	1.315 33.4	300 20.7	407 1.81	0-1/32 0-0.79	2 1/4 57	4 1/2 114	1 3/4 44	2 M10 x 57	1.2 0.5	
1 1/4 32	1.660 42.2	300 20.7	649 2.89	0-1/32 0-0.79	2 5/8 67	4 3/4 121	1 3/4 44	2 M10 x 57	1.3 0.6	
1 1/2 40	1.900 48.3	300 20.7	851 3.78	0-1/32 0-0.79	2 7/8 73	4 7/8 124	1 3/4 44	2 M10 x 57	1.4 0.6	
2 50*	2.375 60.3	300 20.7	1,329 5.91	0-1/32 0-0.79	3 1/4 83	5 1/2 140	1 3/4 44	2 M10 x 57	1.6 0.7	
2 1/2 65	2.875 73.0	300 20.7	1,948 8.66	0-1/32 0-0.79	2 7/8 98	6 152	1 3/4 44	2 M10 x 57	1.9 0.9	
3 O.D. 76.1	2.996 76.1	300 20.7	2,115 9.41	0-1/32 0-0.79	4 102	5 7/8 149	1 3/4 44	2 M10 x 57	1.9 0.9	
3 80	3.500 88.9	300 20.7	2,886 12.84	0-1/32 0-0.79	4 1/2 114	6 1/4 159	1 3/4 44	2 M10 x 70	2.4 1.1	
4 100	4.500 114.3	300 20.7	4,771 21.22	0-3/32 0-2.38	5 3/4 146	7 7/16 189	1 7/8 48	2 M10 x 70	3.5 1.6	
5 1/2 O.D. 139.7	5.500 139.7	300 20.7	7,127 31.70	0-3/32 0-2.38	6 3/4 171	9 1/4 235	2 51	2 M12 x 76	4.5 2.0	
5 125	5.563 141.3	300 20.7	7,292 32.44	0-3/32 0-2.38	6 15/16 173	8 15/16 227	1 7/8 48	2 M12 x 70	4.5 2.0	
6 1/2 O.D. 165.1	6.500 165.1	300 20.7	9,955 44.28	0-3/32 0-2.38	7 3/4 200	10 3/8 264	2 51	2 M12 x 76	5.5 2.5	
6 150	6.625 168.3	300 20.7	10,341 46.00	0-3/32 0-2.38	7 7/8 200	10 1/16 256	1 15/16 49	2 M12 x 70	5.4 2.4	
8 200*	8.625 219.1	300 20.7	17,528 77.97	0-3/32 0-2.38	10 1/8 257	12 7/16 316	2 3/8 60	2 M12 x 70	9.5 4.3	

Notes:

Range of Pipe End Separation values are for roll grooved pipe and may be doubled for cut groove pipe.

† Maximum Working Pressure Rating is for schedule 40 steel pipe. For light wall, stainless steel, aluminum and ISO pipe pressure ratings, please refer to the technical data section.

For additional details see "Coupling Data Chart Notes" in the Introduction Section of the Gruvlok Catalog.
See Installation & Assembly directions in the Technical Data Section of the Gruvlok Catalog.

Hingelok Coupling Fig. 7003



Sizes: 5"–8"

Sizes: 1"–4"

The Fig. 7003 Hingelok Coupling is specially designed for applications requiring a quick connection and/or disconnection of a pipe joint. The Fig. 7003 Hingelok Coupling is ideal for those applications where frequent pipe removal is required for maintenance or any other reason. Fig. 7003 Hingelok Coupling provides for system working pressure ratings up to 300 psi (20.7 bar).

The Fig. 7003 Hingelok Coupling halves are permanently hinged to provide an assembly that eases handling and installation. The two coupling halves are hinged for ease of handling and are secured by a cam-action handle. Sizes 1" to 4" use toggle link plates and sizes 5" to 8" use a toggle bolt to attach the cam-action handle to the housings. The cam-action locking handle permits rapid installation without the need for additional tools and maintains secure closure of the coupling into the pipe grooves. Final assembly of the locking pin to the Hingelok Coupling adds an extra measure of security required in critical pipe joint applications.

Material Specifications

Housing

Ductile Iron conforming to ASTM A536, Grade 65–45–12.

Coatings

Rust inhibiting paint Color: Orange (standard)

Hot Dipped Zinc Galvanized (optional)

Other Colors Available
(IE: RAL3000 and RAL9000)

For other Coating requirements contact an ASC Engineered Solutions™ Representative.

Handle

Sizes 1" – 4": Cold Rolled Carbon Steel Handles

Sizes 5" – 8": Cast Ductile Iron Handles

Links

Sizes 1" – 4": Cold Rolled Carbon Steel Links

Sizes 5" – 8": Heat Treated Steel Links

Locking Pin

Locking Pin: Spring Steel

Material Specifications (Continued)

Gasket Materials

Properties as designated in accordance with ASTM D2000

Grade "EP" EPDM (Green and Red color code)
–40°F to 250°F (Service Temperature Range)
(–40°C to 121°C)

Recommended for water service, diluted acids, alkalis solutions, oil-free air and many other chemical services.

NOT FOR USE IN PETROLEUM APPLICATIONS.

For hot water applications the use of Gruvlok Extreme Temperature lubricant is recommended. NSF-61 Certified for cold and hot water applications up through 12".

Grade "T" Nitrile (Orange color code)
–20°F to 180°F (Service Temperature Range)
(–29°C to 82°C)

Recommended for petroleum applications air with oil vapors and vegetable and mineral oils.

NOT FOR USE IN HOT WATER OR HOT AIR.

Grade "O" Fluoro-Elastomer (Blue color code)
Size Range: 1" – 8" (C style only)
20°F to 300°F (Service Temperature Range)
(–29°C to 149°C)

Recommended for high temperature resistance to oxidizing acids, petroleum oils, hydraulic fluids, halogenated hydrocarbons and lubricants.

Grade "L" Silicone (Red color code)
Size Range: 1" – 8" (C style only)

–40°F to 350°F (Service Temperature Range)
(–40°C to 177°C)

Recommended for dry, hot air and some high temperature chemical services.

DO NOT USE GRUVLOK XTREME LUBRICANT WITH GRADE "L" SILICONE GASKET.

Gasket Type

Standard C Style (1" – 8")

Flush Gap (1" – 8")

Lubrication

Standard Gruvlok

Gruvlok Xtreme (Do Not use with Grade "L")

- Introduction
- Couplings
- Outlets
- Fittings
- Valves & Accessories
- High Pressure
- CTS Copper System
- DI-Electric Nipples
- Plain-End Fittings
- HDPE Couplings
- Socket-® Fittings
- Stainless Steel Method
- Roll Groovers
- Installation & Assembly
- Special Coatings
- Design Services
- Technical Data
- Master Format 3 Part Specs.
- Pictorial Index

Hingelok Coupling Fig. 7003

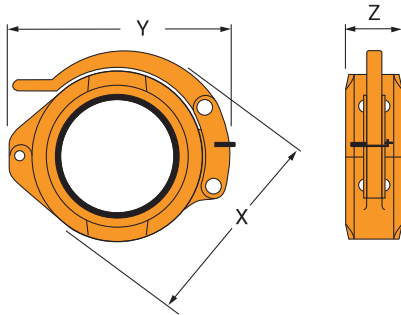

Nominal Size	O.D.	Max. Working Pressure †	Max. End Load	Range of Pipe End Separation	Deflection from ζ		Coupling Dimensions			Approx. Wt. Ea.
					Per Coupling	of Pipe	X	Y	Z	
In./DN(mm)	In./mm	PSI/bar	Lbs./kN	In./mm	Deg.(°)-Min (')	In./ft-mm/m	In./mm	In./mm	In./mm	Lbs./kg
1* 25	1.315 33.4	300 20.7	407 1.81	0-1/32 0-0.79	1° 22'	0.29 23.80	3 76	4 101	1 3/4 44	1.4 0.6
1 1/4* 32	1.660 42.2	300 20.7	649 2.89	0-1/32 0-0.79	1° 5'	0.23 18.80	3 7/16 87	4 7/16 113	1 7/8 48	1.5 0.7
1 1/2 40	1.900 48.3	300 20.7	851 3.78	0-1/32 0-0.79	0° 57'	0.2 16.50	3 5/8 92	4 1/4 108	1 7/8 48	1.7 0.8
2 50	2.375 60.3	300 20.7	1,329 5.91	0-1/32 0-0.79	0° 45'	0.16 13.10	4 1/4 108	4 7/8 124	1 7/8 48	2.2 1.0
2 1/2 65	2.875 73.0	300 20.7	1,948 8.66	0-1/32 0-0.79	0° 37'	0.13 10.90	5 1/4 133	5 7/8 149	1 7/8 48	3.2 1.5
3 80	3.500 88.9	300 20.7	2,886 12.84	0-1/32 0-0.79	0° 31'	0.11 8.90	5 5/8 143	6 1/2 165	1 7/8 48	3.6 1.6
4 100	4.500 114.3	300 20.7	4,771 21.22	0-3/32 0-2.38	1° 12'	0.25 20.80	7 178	7 3/4 197	2 51	5.1 2.3
5 125	5.563 141.3	300 20.7	7,292 32.44	0-3/32 0-2.38	0° 58'	0.2 16.80	8 5/8 219	9 1/2 241	2 1/8 54	9.5 4.3
6 150	6.625 168.3	300 20.7	10,341 46.00	0-3/32 0-2.38	0° 49'	0.17 14.14	9 7/8 251	10 7/8 276	2 1/8 54	11.2 5.1
8 200	8.625 219.1	300 20.7	17,528 77.97	0-3/32 0-2.38	0° 37'	0.13 10.90	12 305	13 1/8 333	2 1/2 64	18.1 8.2

Notes:

*1" and 1 1/4" are import products.

Range of Pipe End Separation and Angular Deflection values are for roll grooved pipe and may be doubled for cut groove pipe. See the Technical Data Section of the Gruvlok Catalog. For Misalignment, Deflection and Curve Layout Calculations, refer to the Technical Data Section of the Gruvlok Catalog for details.

† Maximum Working Pressure Rating is for schedule 40 steel pipe. For light wall, stainless steel, aluminum and ISO pipe pressure ratings, please refer to the technical data section.

For additional details see "Coupling Data Chart Notes" in the Introduction Section of the Gruvlok Catalog.

See Installation & Assembly directions in the Technical Data Section of the Gruvlok Catalog.

Not for use in copper systems.

Special Note:

Fig. 7003 Hingelok Couplings are not designed for eccentric loading and therefore are not recommended for use at the end of concrete pumping booms or vertical risers above 30 feet (9.1 meters). Shockload must be considered and is to be included in the maximum working pressure listed above. Coupling keys, gasket cavity, and pipe grooves must be kept free of all foreign matter. Proper anchoring practice must always be exercised.

CAUTION:

Hammering or banging on the handle or coupling housing could cause serious damage to the locking device and coupling assembly. The result may be an unsuitable pipe joint and unusable coupling assembly. When re-using, always check for gasket damage, housing hinge and handle for looseness, distortion, bending or any other damage.

Reducing Coupling Fig. 7010

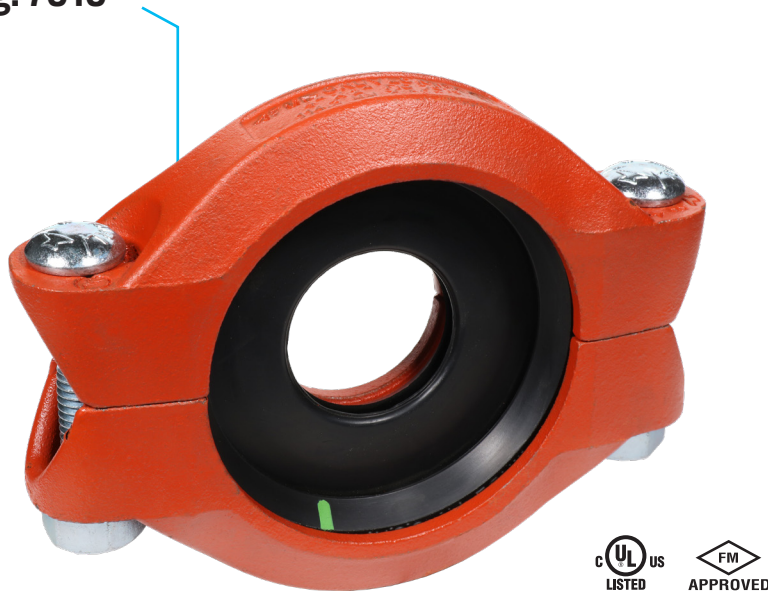

The Fig. 7010 Reducing Coupling makes it possible to directly connect two different pipe sizes, eliminating the need for two couplings and a reducing fitting. The specially designed reducing coupling gasket with a center rib assures proper positioning of the gasket and prevents the smaller pipe from telescoping into the larger during assembly. Fig. 7010 Reducing Coupling allows for working pressure ratings up to 500 PSI (34.5 bar). Not recommended for vacuum applications.

For Listings/Approval Details and Limitations, visit our website at www.asc-es.com or contact an ASC Engineered Solutions™ Sales Representative.

Material Specifications

Bolts

SAE J429, Grade 5, Zinc Electroplated
ISO 898-1, Class 8.8, Zinc Electroplated followed by a Yellow Chromate Dip

Heavy Hex Nuts

ASTM A563, Grade A, Zinc Electroplated
ISO 898-2, Class 8.8, Zinc Electroplated followed by a Yellow Chromate Dip

Hardware Kits

304 Stainless Steel (available in sizes up to ¾")

Kit includes:

- (2) Bolts per ASTM A193, Grade B8 and
- (2) Heavy Hex Nuts per ASTM A194, Grade 8.

EcoGuard (available in sizes up to ¾")

Kit includes:

- (2) Bolts per SAE J429, Grade 5, with EcoGuard corrosion-resistant zinc flake coating and
- (2) Heavy Hex Nuts per ASTM A563, Grade A, EcoGuard corrosion-resistant zinc flake coating.

Housing

Ductile Iron conforming to ASTM A 536, Grade 65-45-12, or

Malleable Iron conforming to ASTM A 47, Grade 32510.

Coatings

Rust inhibiting paint

Color: Orange (standard)

Hot Dipped Zinc Galvanized (optional)

Gaskets

Properties as designated in accordance with ASTM D2000

Grade "E" EPDM (Green color code)

-40°F to 230°F (Service Temperature Range)
(-40°C to 110°C)

Recommended for water service, diluted acids, alkalies solutions, oil-free air and many other chemical services.

NOT FOR USE IN PETROLEUM APPLICATIONS.

Grade "T" Nitrile (Orange color code)

-20°F to 180°F (Service Temperature Range)
(-29°C to 82°C)

Recommended for petroleum applications, air with oil vapors and vegetable and mineral oils.
NOT FOR USE IN HOT WATER OR HOT AIR.

Lubrication

Standard Gruvlok

Gruvlok Xtreme (Do Not use for Grade "L")

Reducing Coupling Fig. 7010

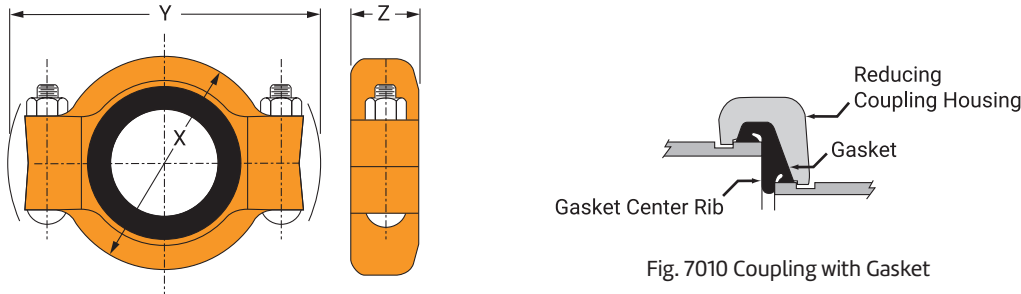

Fig. 7010 Coupling with Gasket

Nominal Size	Larger O.D.	Smaller O.D.	Max. Working Pressure†	Max. End Load	Range of Pipe End Separation	Deflection Per Coupling	Form ϕ of Pipe	Coupling Dimensions			Coupling Bolts Qty.	Coupling Bolts Size	Specified Torque §		Approx. Wt. Ea.
								X	Y	Z			Min.	Max.	
In./DN(mm)	In./mm	In./mm	PSI/bar	Lbs./kN	In./mm	Deg(°)-Min(')	In./Ft.-mm/m	In./mm	In./mm	In./mm	In./mm	Ft.-Lbs./N-m	Ft.-Lbs./N-m	Lbs./kg	
2 x 1½ 50 x 40	2.375 60.3	1.900 48.3	500 34.5	2,215 9.85	0-½ 0-0.79	0° 45'	0.16 13.1	3⅝ 92	5⅞ 149	1⅞ 48	2	½ x 2¾ M12 x 76	80 110	100 150	2.0 0.9
2½ x 2 65 x 50	2.875 73.0	2.375 60.3	500 34.5	3,246 14.44	0-½ 0-0.79	0° 37'	0.13 10.9	4¼ 108	6⅜ 162	1⅞ 48	2	½ x 2¾ M12 x 76	80 110	100 150	3.5 1.6
3 x 2 80 x 50	3.500 88.9	2.375 60.3	500 34.5	4,811 21.40	0-½ 0-0.79	0° 31'	0.11 8.9	4⅞ 124	7⅞ 181	1⅞ 48	2	½ x 2¾ M12 x 76	80 110	100 150	4.4 2.0
3 x 2½ 80 x 65	3.500 88.9	2.875 73.0	500 34.5	4,811 21.40	0-½ 0-0.79	0° 31'	0.11 8.9	4⅞ 124	7⅞ 181	1⅞ 48	2	½ x 2¾ M12 x 76	80 110	100 150	4.1 1.9
4 x 2 100 x 50	4.500 114.3	2.375 60.3	500 34.5	7,952 35.37	0-¾ 0-2.38	1° 12'	0.25 20.8	6¼ 159	8⅞ 225	2 51	2	⅝ x 3½ M16 x 95	100 135	130 175	8.9 4.0
4 x 2½ 100 x 65	4.500 114.3	2.875 73.0	500 34.5	7,952 35.37	0-¾ 0-2.38	1° 12'	0.25 20.8	6¼ 159	8⅞ 225	2 51	2	⅝ x 3½ M16 x 95	100 135	130 175	7.9 3.6
4 x 3 100 x 80	4.500 114.3	3.500 88.9	500 34.5	7,952 35.37	0-¾ 0-2.38	1° 12'	0.25 20.8	6¼ 159	8⅞ 225	2 51	2	⅝ x 3½ M16 x 95	100 135	130 175	6.7 3.0
5 x 4 125 x 100	5.563 141.3	4.500 114.3	500 34.5	12,153 54.06	0-¾ 0-2.38	1° 58'	0.20 16.8	7¼ 184	10⅝ 270	2⅞ 54	2	¾ x 4½ M20 x 115	130 175	180 245	11.4 5.2
6 x 4 150 x 100	6.625 168.3	4.500 114.3	500 34.5	17,236 76.67	0-¾ 0-2.38	0° 49'	0.17 14.1	8¼ 210	11⅝ 295	2⅞ 54	2	¾ x 4½ M20 x 115	130 175	180 245	13.4 6.1
6 x 5 150 x 125	6.625 168.3	5.562 141.3	500 34.5	17,236 76.67	0-¾ 0-2.38	0° 49'	0.17 14.1	8½ 216	11⅝ 295	2⅞ 54	2	¾ x 4½ M20 x 115	130 175	180 245	13.5 6.1
8 x 6 200 x 150	8.625 219.1	6.625 168.3	500 34.5	29,213 129.95	0-¾ 0-2.38	0° 37'	0.13 10.9	10½ 267	14 356	2¼ 57	2	¾ x 4½ M20 x 115	130 175	180 245	17.7 8.0

Notes:

Fig. 7010 Reducing Coupling should not be used with end caps in systems where a vacuum may be developed.

Contact your ASC Engineered Solutions™ Representative for details.

Range of Pipe End Separation and Angular Deflection values are for roll grooved pipe and may be doubled for cut groove pipe.

See the Technical Data Section of the Gruvlok Catalog for details.

For Misalignment, Deflection and Curve Layout Calculations, refer to the Technical Data Section of the Gruvlok Catalog.

† Maximum Working Pressure Rating is for schedule 40 steel pipe. For light wall, stainless steel, aluminum and ISO pipe pressure ratings, please refer to the technical data section.

For additional details see "Coupling Data Chart Notes" in the Introduction Section of the Gruvlok Catalog.

§ – For additional Bolt Torque information, see the Technical Data Section of the Gruvlok Catalog.

See Installation & Assembly directions in the Technical Data Section of the Gruvlok Catalog.

Not for use in copper systems.

Gruvlok Flange Adapter Fig. 7788

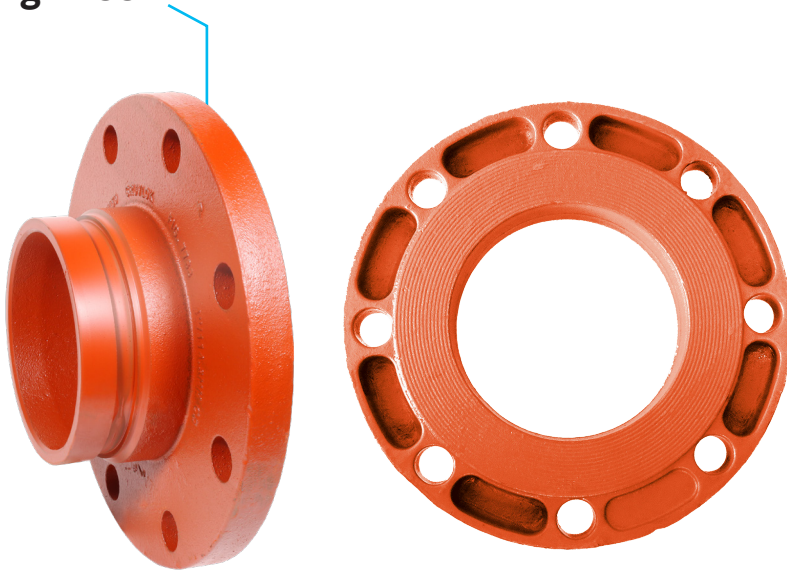

The Gruvlok Fig. 7788 Flange Adapter allows for direct connection of Class 125 or Class 150 flanged components to a grooved piping system. The Gruvlok Flange Adapter provides an alternative method of connecting to flanged components than the traditional Fig. 7012 Gruvlok Flange. The Gruvlok Flange Adapter provides a raised serrated face flange connection with a shorter overall length than ASC's Fig. 7084 Flange x Groove Nipple.

Material Specifications

Housing

Ductile Iron conforming to ASTM A536, Grade 65-45-12

Coatings

Rust inhibiting paint - Color: Orange (standard), Red (optional)

Hot Dipped Zinc Galvanized (optional)

Other Colors Available

(IE: RAL3000 and RAL9000)

For other Coating requirements contact an ASC Engineered Solutions™ Representative for more information.

Gruvlok Flange Adapter Fig. 7788

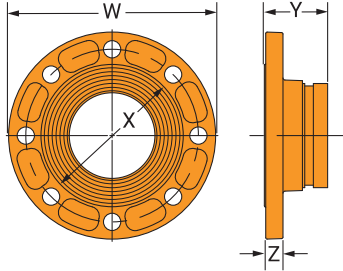

Nominal Size	O.D.	Max. Working Pressure	Coupling Dimensions				Qty.	Size	Coupling Bolts		Specified Torque		Approx. Wt. Ea.
			W	X	Y	Z			Bolt Circle Diameter	Bolt Hole Diameter	Min.	Max.	
In./DN(mm)	In./mm	PSI/bar	In./mm	In./mm	In./mm	In./mm	PN(10) (16)	In. (ISO)/mm	In./mm	In./mm	Ft.-Lbs/N-m		Lbs./kg
2 50	2.375 60.3	300 20.7	6 152.4	3 ⁵ / ₈ 91.9	2 ¹ / ₂ 63.5	1 ¹ / ₁₆ 17.5	4	5 ⁸ / ₈ X 2 ³ / ₄ M16 x 70	4 ³ / ₄ 120.7	3 ⁴ / ₄ 19.1	110 149	140 190	4.39 2.0
2 ¹ / ₂ 65	2.875 73.0	300 20.7	7 177.8	4 ¹ / ₈ 104.6	2 ¹ / ₂ 63.5	3 ⁴ / ₄ 19.1	4	5 ⁸ / ₈ X 2 ³ / ₄ M16 x 70	5 ¹ / ₂ 139.7	3 ⁴ / ₄ 19.1	110 149	140 190	6.17 2.8
3 80	3.500 88.9	300 20.7	7 ¹ / ₂ 190.5	5 127.0	2 ¹ / ₂ 63.5	3 ⁴ / ₄ 19.1	4	5 ⁸ / ₈ X 2 ³ / ₄ M16 x 70	6 152.4	3 ⁴ / ₄ 19.1	110 149	140 190	7.19 3.3
4 100	4.500 114.3	300 20.7	9 228.6	6 ³ / ₁₆ 157.2	2 ³ / ₄ 69.9	3 ⁴ / ₄ 19.1	8	5 ⁸ / ₈ X 2 ³ / ₄ M16 x 70	7 ¹ / ₂ 190.5	3 ⁴ / ₄ 19.1	110 149	140 190	10.68 4.9
5 125	5.563 141.3	300 20.7	10 254.0	7 ⁵ / ₁₆ 185.7	2 ³ / ₄ 69.9	7 ⁸ / ₈ 22.1	8	3 ⁴ / ₄ X 2 ⁷ / ₈ —	8 ¹ / ₂ 215.9	7 ⁸ / ₈ 22.2	220 298	250 339	13.99 6.4
6 150	6.625 168.3	300 20.7	11 279.4	8 ¹ / ₂ 215.9	2 ³ / ₄ 69.9	7 ⁸ / ₈ 22.1	8	3 ⁴ / ₄ X 3 ¹ / ₈ M20 x 80	9 ¹ / ₂ 241.1	7 ⁸ / ₈ 22.2	220 298	250 339	16.47 7.5
8* 200	8.625 219.1	300 20.7	13 ¹ / ₂ 342.9	10 ⁵ / ₈ 269.7	3 76.2	6 ¹ / ₆₄ 24.1	8	3 ⁴ / ₄ X 3 ¹ / ₄ M20 x 80	11 ³ / ₄ 298.5	7 ⁸ / ₈ 22.2	220 298	250 339	24.79 11.3
10* 250	10.750 273.1	300 20.7	16 406.4	12 ³ / ₄ 323.9	3 ³ / ₈ 85.7	1 25.4	12	7 ⁸ / ₈ X 3 ¹ / ₂ M20 x 90	14 ¹ / ₄ 362.0	1 25.4	320 439	400 542	36.75 16.7
12* 300	12.750 323.9	300 20.7	19 482.6	15 381.0	3 ¹ / ₂ 88.9	1 ¹³ / ₆₄ 30.5	12	7 ⁸ / ₈ X 3 ³ / ₄ —	17 431.8	1 25.4	320 439	400 542	56.31 25.6

Note:

*8", 10" and 12" Flange Adapters have a machined raise face. 2" through 6" Flange Adapters have a cast raised face.

Gruvlok® Flanges Fig. 7012

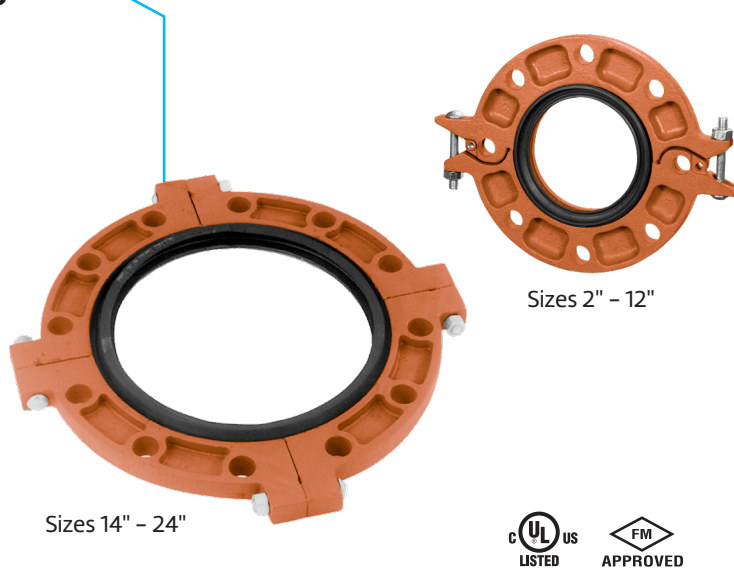

The Gruvlok Fig. 7012 Flange allows direct connection of Class 125 or Class 150 flanged components to a grooved piping system. The two interlocking halves of the 2" thru 12" sizes of the Gruvlok Flange are hinged for ease of handling, and are drawn together by a latch bolt which eases assembly on the pipe. Precision machined bolt holes, key and mating surfaces assure concentricity and flatness to provide exact fix-up with flanged, lug, and wafer styles of pipe system equipment. A specially designed gasket provides a leak-tight seal on both the pipe and the mating flange face.

The 14" thru 24" sizes of the Gruvlok Fig. 7012 Flange are cast in four segments. A sleek profile gasket design allows quick and easy assembly of the Gruvlok Flange onto the pipe.

All Gruvlok Fig. 7012 Flanges have designed-in anti-rotation tines which bite into and grip the sides of the pipe grooves to provide a secure, rigid connection.

The Gruvlok Fig. 7012 Flange requires the use of a steel adapter insert when used against rubber faced surfaces, wafer/lug design valves and serrated or irregular sealing surfaces. In copper systems a phenolic adapter insert is required, in place of the steel adapter insert. (See Installation and Assembly Instructions Section or contact your ASC Engineered Solutions™ Representative for details.)

For Listings/Approval Details and Limitations, visit our website at www.asc-es.com or contact an ASC Engineered Solutions Sales Representative.

Material Specifications

Latch Bolt (2" – 12", Segment Bolt (14" – 24"

SAE J429, Grade 5, Zinc Electroplated
ISO 898-1, Class 8.8, Zinc Electroplated followed by a Yellow Chromate Dip

Latch Nut (2" – 12", Segment Nut (14" – 24"

ASTM A563, Grade A, Zinc Electroplated
ISO 898-2, Class 8.8, Zinc Electroplated followed by a Yellow Chromate Dip

Housing

Ductile Iron conforming to ASTM A536, Grade 65-45-12.

Coatings

Rust inhibiting paint
Color: Orange (standard), Red (optional)
Hot Dipped Zinc Galvanized (optional)
Other Colors Available
(IE: RAL3000 and RAL9000)

For other Coating requirements contact an ASC Engineered Solutions Representative.

Gasket Materials

Properties as designated in accordance with ASTM D2000

Grade "E" EPDM (Green color code)

-40°F to 230°F (Service Temperature Range)
(-40°C to 110°C)

Recommended for water service, diluted acids, alkalis solutions, oil-free air and many other chemical services.

NOT FOR USE IN PETROLEUM APPLICATIONS.

Grade "T" Nitrile (Orange color code)

-20°F to 180°F (Service Temperature Range)
(-29°C to 82°C)

Recommended for petroleum applications.
Air with oil vapors and vegetable and mineral oils.
NOT FOR USE IN HOT WATER.

Lubrication

Standard Gruvlok

Gruvlok Xtreme (Do not use with Grade "L")



Gruvlok® Flanges Fig. 7012

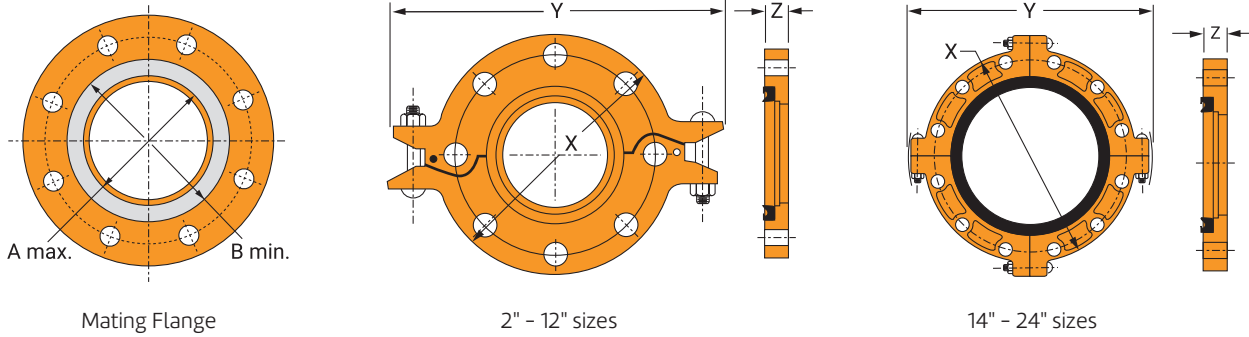

Nominal Size	O.D.	Max. Working Pressure†	Max. End Load▼	Latch Bolt		Dimensions			Sealing Surface		Mating Flange Bolts					Approx. Wt. Ea.		
				Latch Bolt Size*	Specified Torque §	X	Y	Z	A Max.	B Min.	Mating Flange Bolts Qty. ANSI Size (ANSI)	Bolt Circle Diameter	Bolt Hole Diameter	Specified Torque §				
In./DN(mm)	In./mm	PSI/bar	Lbs./kN	In./mm	Ft.-Lbs/N-m	In./mm	In./mm	In./mm	In./mm	In./mm	PN10 (16)	In. (ISO) mm	In./mm	In./mm	Ft.-Lbs/N-m	Lbs./kg		
2 50	2.375 60.3	300 20.7	1,329 5.91	3/8 x 2 3/4 M10 x 70	30 40	45 60	6 1/4 159	8 3/8 213	3/4 19	2 3/8 60	3 7/16 87	4 4	5/8 x 2 3/4 M16 x 70	4 3/4 120.7	3/4 19.1	110 149	140 190	4.2 1.9
2 1/2 65	2.875 73.0	300 20.7	1,948 8.66	3/8 x 2 3/4 M10 x 70	30 40	45 60	7 178	9 1/2 241	3/4 19	2 7/8 73	4 102	4 —	5/8 x 2 3/4 M16 x 70	5 1/2 139.7	3/4 19.1	110 149	140 190	4.6 2.1
3 O.D. 76.1	2.996 76.1	300 20.7	2,115 9.41	— M10 x 70	30 40	45 60	7 1/4 184	9 3/4 248	3/4 19	3 76	4 1/8 105	— 4	— M16 x 70	— —	— —	110 149	140 190	4.8 2.2
3 88.9	3.500 88.9	300 20.7	2,886 12.84	3/8 x 2 3/4 M10 x 70	30 40	45 60	7 7/8 200	10 1/2 267	3/4 19	3 1/2 89	4 9/16 116	4 8	5/8 x 2 3/4 M16 x 70	6 152.4	3/4 19.1	110 149	140 190	6.0 2.7
4 100	4.500 114.3	300 20.7	4,771 21.22	3/8 x 2 3/4 M10 x 70	30 40	45 60	9 229	11 1/2 292	3/4 19	4 1/2 114	5 9/16 141	8 8	5/8 x 2 3/4 M16 x 70	7 1/2 190.5	3/4 19.1	110 149	140 190	6.3 2.9
5 1/2 O.D. 139.7	5.500 139.7	300 20.7	7,127 31.70	— M10 x 70	30 40	45 60	9 7/8 251	12 7/8 327	7/8 22	5 9/16 141	6 3/4 171	— 8	— M16 x 75	— —	— —	220 298	250 339	15.6 7.1
5 125	5.563 141.3	300 20.7	7,292 32.44	3/8 x 2 3/4 M10 x 70	30 40	45 60	10 254	12 1/2 318	7/8 22	5 9/16 141	6 3/4 171	8 —	3/4 x 2 7/8 —	8 1/2 215.9	7/8 22.2	220 298	250 339	8.8 4.0
6 1/2 O.D. 165.1	6.500 165.1	300 20.7	9,955 44.28	— M10 x 70	30 40	45 60	11 1/4 286	14 356	7/8 22	6 5/8 168	7 13/16 198	— 8	— M20 x 80	— —	— —	220 298	250 339	9.7 4.4
6 150	6.625 168.3	300 20.7	10,341 46.00	3/8 x 2 3/4 M10 x 70	30 40	45 60	11 279	14 356	7/8 22	6 5/8 168	7 13/16 198	8 8	3/4 x 3 1/8 M20 x 80	9 1/2 241.1	7/8 22.2	220 298	250 339	9.6 4.4
8 200	8.625 219.1	300 20.7	17,528 77.97	3/8 x 2 3/4 M10 x 70	30 40	45 60	13 1/2 343	16 1/2 419	1 25	8 5/8 219	10 254	8 8 (12)	3/4 x 3 1/4 M20 x 80	11 3/4 298.5	7/8 22.2	220 298	250 339	15.6 7.1
10 250	10.750 273.1	300 20.7	27,229 121.12	3/8 x 2 3/4 M10 x 70	30 40	45 60	16 406	19 483	1 25	10 3/4 273	12 1/8 308	12 12	7/8 x 3 1/2 M20 x 90	14 1/4 362.0	1 25.4	320 439	400 542	18.2 8.3

Gruvlok® Flanges (Continued) Fig. 7012

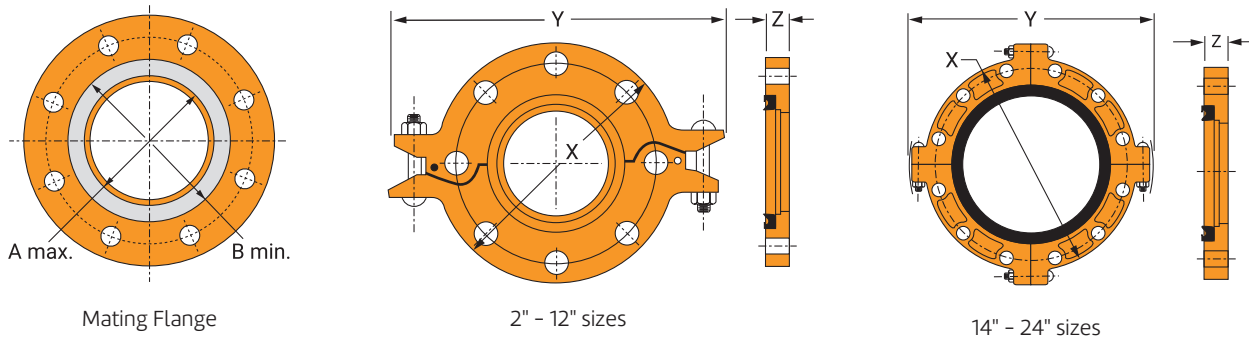

Nominal Size	O.D.	Max. Working Pressure †	Max. End Load ▼	Latch Bolt		Dimensions			Sealing Surface		Mating Flange Bolts				Approx. Wt. Ea.			
				Latch Bolt Size*	Specified Torque §	X	Y	Z	A Max.	B Min.	Mating Flange Bolts Qty. ANSI Size (ANSI)	Bolt Circle Diameter	Bolt Hole Diameter	Specified Torque §				
DN (mm)	In./mm	PSI/bar	Lbs./kN	In./mm	Ft.-Lbs/N-m	In./mm	In./mm	In./mm	In./mm	In./mm	PN10 (16)	In. (ISO) mm	In./mm	In./mm	Ft.-Lbs/N-m	Lbs./kg		
12	12.750	300	38,303	3/8 x 2 3/4	30	45	19	21 3/4	1 1/4	12 3/4	14 1/8	12	7/8 x 3 3/4	17	1	320	400	29.9
300	323.9	20.7	170.38	M10 x 70	40	60	483	552	32	324	359	12	—	431.8	25.4	439	542	13.6
14	14.000	300	46,181	5/8 x 4 1/4	100	130	21	24	1 1/2	14	16	12	1 x 4 1/4	18 3/4	1 1/8	360	520	52.5
350	355.6	20.7	205.43	—	136	176	533	610	38	356	406	—	—	476.3	28.6	488	705	23.8
16	16.000	300	60,319	5/8 x 4 1/4	100	130	23 1/2	26 1/2	1 1/2	16	18	16	1 x 4 1/4	21 1/4	1 1/8	360	520	67.0
400	406.4	20.7	268.31	—	136	176	597	673	38	406	457	—	—	539.8	28.6	488	705	30.4
18	18.000	300	76,341	3/4 x 5	130	180	25	29	1 5/8	18	20	16	1 1/8 x 4 3/4	22 3/4	1 1/4	450	725	82.5
450	457.2	20.7	339.58	—	176	244	635	737	41	457	508	—	—	577.9	31.8	610	983	37.4
20	20.000	300	94,248	3/4 x 5	130	180	27 1/2	31 1/2	1 3/4	20	22	20	1 1/8 x 4 3/4	25	1 1/4	450	725	106.5
500	508.0	20.7	419.23	—	176	244	699	800	44	508	559	—	—	635.0	31.8	610	983	48.3
24	24.000	250	113,097	7/8 x 5 1/2	180	220	32	36 1/2	1 7/8	24	26	20	1 1/8 x 5 1/2	29 1/2	1 3/8	620	1,000	138.5
600	609.6	17.2	503.08	—	244	298	813	927	48	610	660	—	—	749.3	34.92	841	1,356	62.8

Note:

† Maximum Working Pressure Rating is for schedule 40 steel pipe. For light wall, stainless steel, aluminum and ISO pipe pressure ratings, please refer to the Technical Data section.

The Gruvlok Flange bolt hole pattern conforms to ANSI Class 150 and Class 125 flanges.

To avoid interference issues, flanges cannot be assembled directly to Series 7700 butterfly valve. Flange can be assembled to one side of series 7500 and 7600 valve only. Mating flange bolts must be at least Intermediate Strength Bolting per ASME B16.5. Bolts with material properties equal or greater than SAE J429 Grade 5 are acceptable.

For additional details see "Coupling Dat Chart Notes" in the Introduction Section of the Gruvlok Catalog.

+ PN 16 uses M24 x 90 (PN) Dimensions for bolt circle PN 10 & 16 Flange.

* Available in ANSI or metric bolt sizes only as indicated.

▼ Based on use with standard wall pipe

§ – For additional Bolt Torque information, see the Technical Data Section of the Gruvlok Catalog. See Installation & Assembly directions in the Technical Data Section of the Gruvlok Catalog.

Gruvlok Flanges (300# Flange) Fig. 7013

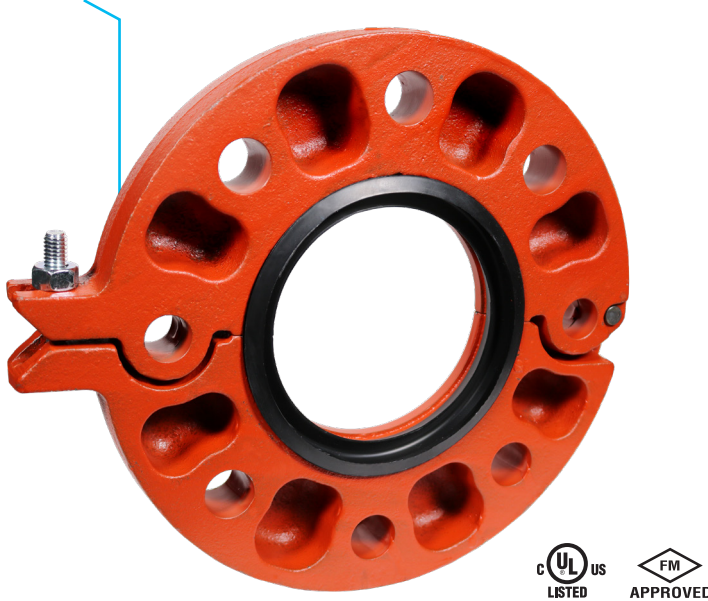

The Gruvlok Fig. 7013 300# Flange allows direct connection of Class 250 or Class 300 flanged components to a Gruvlok piping system. The two halves of the 2" thru 12" sizes of both Gruvlok Flanges are drawn together by a latch bolt which eases assembly on the pipe. A specially designed gasket provides a leak-tight seal on both the pipe and the mating flange face.

Gruvlok Flanges have designed-in anti-rotation tines which bite into and grip the side of the pipe groove to provide a secure, rigid connection.

Gruvlok flange adapter insert required when mating to rubber surfaces or serrated faced mating flanges.

***The 7013 Gruvlok adapter flange should not be used with the 78FP or 7800 check valve.**

For Listings/Approval Details and Limitations, visit our website at www.asc-es.com or contact an ASC Engineered Solutions™ Sales Representative.

Material Specifications

Bolts

SAE J429, Grade 5, Zinc Electroplated
ISO 898-1, Class 8.8, Zinc Electroplated
followed by a Yellow Chromate Dip

Heavy Hex Nuts

ASTM A563, Grade A, Zinc Electroplated
ISO 898-2, Class 8.8, Zinc Electroplated
followed by a Yellow Chromate Dip

Hardware Kits

304 Stainless Steel (available in sizes up to ½")
Kit includes:

- (2) Bolts per ASTM A193, Grade B8
- (2) Heavy Hex Nuts per ASTM A194, Grade 8

EcoGuard (available in sizes up to ½")

Kit includes:

- (2) Bolts per SAE J429, Grade 5, with EcoGuard corrosion-resistant zinc flake coating
- (2) Heavy Hex Nuts per ASTM A563, Grade A, EcoGuard corrosion-resistant zinc flake coating

Housing

Ductile Iron conforming to ASTM A536,
Grade 65-45-12

Coatings

Rust inhibiting paint

Color: Orange (standard)

Hot Dipped Zinc Galvanized (optional)

Gaskets

Properties as designated in accordance with
ASTM D2000

Grade "EP" EPDM (Green color code)

-40°F to 230°F (Service Temperature Range)
(-40°C to 110°C)

Recommended for water service, diluted acids, alkalis solutions, oil-free air and many other chemical services.

NOT FOR USE IN PETROLEUM APPLICATIONS.

Grade "T" Nitrile (Orange color code)

-20°F to 180°F (Service Temperature Range)
(-29°C to 82°C)

Recommended for petroleum applications. Air with oil vapors and vegetable and mineral oils.

NOT FOR USE IN HOT WATER OR HOT AIR.

Lubrication

Standard Gruvlok

Gruvlok Xtreme (Do Not use for Grade "L")

Gruvlok Flanges (300# Flange) Fig. 7013

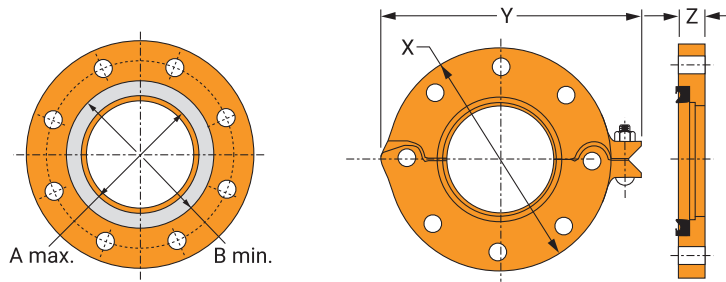

Mating Flange

ANSI Class 250 And 300 Bolt Pattern

Nominal Size	O.D.	Max. Working Pressure†	Max. End Load▼	Latch* Bolt Size	Specified Torque §		Dimensions			Sealing Surface		Qty. ANSI	Mating Flange Bolts			Approx. Wt. Ea.
					Min.	Max.	X	Y	Z	A Max.	B Min.		Size (ANSI) In.	Bolt Circle Diameter	Bolt Hole Diameter	
In./DN(mm)	In./mm	PSI/bar	Lbs./kN	In.	Fl.-Lbs/N-m	Ft.-Lbs/N-m	In./mm	In./mm	In./mm	In./mm	In./mm		(ISO) mm	In./mm	In./mm	Lbs./Kg
2 50	2.375 60.3	750 51.7	3,323 14.78	3/8 x 2 1/2 -	30 -	45 -	6 1/2 165	8 203	1 25	2 3/8 60	3 7/16 87	8 -	5/8 x 3 -	5 127.0	3/4 19.1	5.0 2.3
2 1/2 65	2.875 73.0	750 51.7	4,869 21.66	3/8 x 2 1/2 -	30 -	45 -	7 1/2 191	9 1/8 232	1 25	2 7/8 73	4 102	8 -	3/4 x 3 1/4 -	5 7/8 149.2	7/8 22.2	6.9 3.1
3 80	3.500 88.9	750 51.7	7,216 32.10	3/8 x 2 1/2 -	30 -	45 -	8 1/4 210	9 7/8 251	1 1/8 29	3 1/2 89	4 9/16 116	8 -	3/4 x 3 1/2 -	6 5/8 168.3	7/8 22.2	9.4 4.3
4 100	4.500 114.3	750 51.7	11,928 53.06	3/8 x 2 1/2 -	30 -	45 -	10 254	11 3/8 289	1 1/4 32	4 1/2 114	5 5/8 143	8 -	3/4 x 3 3/4 -	7 7/8 200.0	7/8 22.2	14.4 6.5
5 125	5.563 141.3	750 51.7	18,229 81.09	3/8 x 2 1/2 -	30 -	45 -	11 279	12 5/8 321	1 3/8 35	5 9/16 141	6 3/4 171	8 -	3/4 x 4 1/2 -	9 1/4 235.0	7/8 22.2	18.3 8.3
6 150	6.625 168.3	750 51.7	25,854 115.00	3/8 x 2 1/2 -	30 -	45 -	12 1/2 318	14 1/8 359	1 1/2 38	6 5/8 168	7 13/16 198	12 -	3/4 x 4 1/2 -	10 5/8 269.9	7/8 22.2	24.9 11.3
8 200	8.625 219.1	750 51.7	43,820 194.92	1/2 x 3 1/2 -	80 -	100 -	15 381	16 7/8 429	1 5/8 41	8 5/8 219	10 254	12 -	7/8 x 4 3/4 -	13 330.2	1 25.4	35.4 16.1
10 250	10.750 273.1	750 51.7	68,072 302.80	1/2 x 3 1/2 -	80 -	100 -	17 1/2 445	19 3/8 492	1 7/8 48	10 3/4 273	12 1/8 308	16 -	1 x 5 -	15 1/4 387.4	1 1/8 28.6	54.0 24.5
12 300	12.750 323.9	600 41.4	76,605 333.79	1/2 x 3 1/2 -	80 -	100 -	20 1/2 521	22 1/2 572	2 51	12 3/4 324	14 3/16 360	16 -	1 1/8 x 5 3/4 -	17 3/4 450.9	1 1/4 31.8	74.8 33.9

Notes:

† Maximum Working Pressure Rating is for schedule 40 steel pipe. For light wall, stainless steel, aluminum and ISO pipe pressure ratings, please refer to the technical data section.

Effective sealing area of mating flange must be free from gouges, undulations or deformities of any type to ensure proper sealing of the gasket.

Flange cannot be assembled directly to Series 7700 butterfly valve. Flange can be assembled to one side of series 7500 and 7600 valve.

For additional details see "Coupling Data Chart Notes" in the Introduction Section of the Gruvlok Catalog.

*Available in ANSI or metric bolt sizes only as indicated.

▼ Based on use with standard wall pipe.

§ - For additional Bolt Torque information, see the Technical Data Section of the Gruvlok Catalog.

See Installation & Assembly directions or contact your ASC Engineered Solutions™ Representative

Not for use with copper systems.

Gruvlok Flanges (300# Flange) Fig. 7013

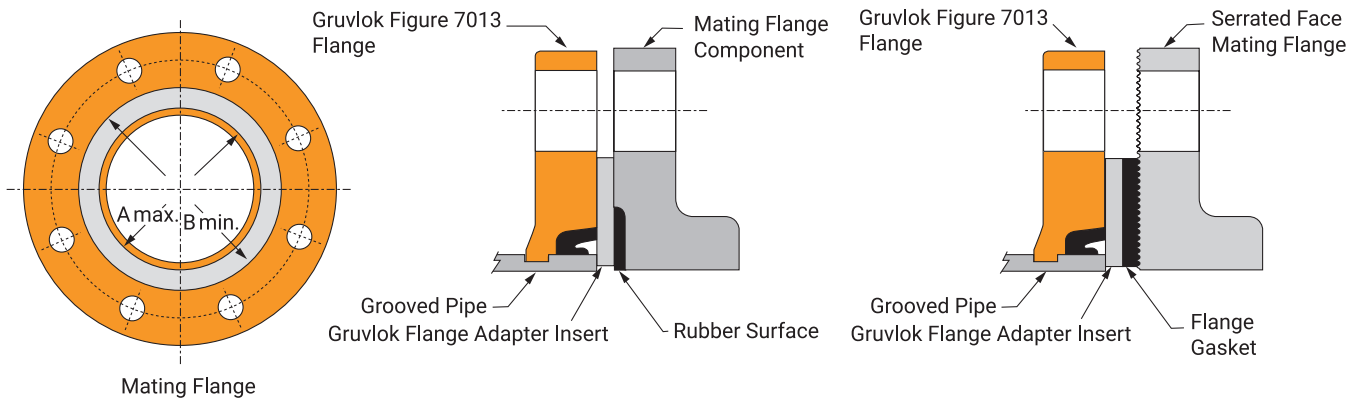

- A.** The sealing surfaces A Max. to B Min. of the mating flange must be free from gouges, undulations and deformities of any type to ensure proper sealing of the gasket.
- B.** Gruvlok Flanges are to be assembled on butterfly valves so as not to interfere with actuator or handle operation.
- C.** Do not use Gruvlok Flanges within 90 degrees of one another on standard fittings because the outside dimensions may cause interference.
- D.** Gruvlok Flanges should not be used as anchor points for tierods across non-restrained joints.
- E.** Fig. 7013 Gruvlok Flange sealing gaskets require a hard flat surface for adequate sealing. The use of a Gruvlok Flange Adapter Insert is required for applications against rubber faced valves or other equipment. The Gruvlok Flange Adapter Insert is installed between the Gruvlok Flange sealing gasket and the mating flange or surface to provide a good sealing surface area.
- F.** Gruvlok Flanges are not recommended for use against formed rubber flanges.
- G.** Contact an ASC Engineered Solutions™ Representative for Di-Electric Flange connections.

Applications which require a Gruvlok Flange Adapter Insert

- 1.** When mating to a wafer valve (lug valve), if the valve is rubber faced in the area designated by the sealing surface dimensions (A Max. to B Min.), place the Gruvlok Flange Adapter Insert between the valve and the Gruvlok flange.
- 2.** When mating to a rubber-faced metal flange, the Gruvlok Flange Adapter Insert is placed between the Gruvlok Flange and the rubber-faced flange.
- 3.** When mating to a serrated flange surface, a standard full-faced flange gasket is installed against the serrated flange face and the Gruvlok Flange Adapter Insert is placed between the Gruvlok Flange and the standard Flange gasket.
- 4.** When mating to valves or other component equipment where the flange face has an insert, use procedure described in note 3.

Flange Adapter Inserts for use with Fig. 7012/7013 Flanges Flanged Seal Rings



Material Specifications

Carbon steel conforming to ASTM A 1011
Carbon steel rings come zinc
electroplated standard
Ring thickness: 0.120" (all sizes and styles)

The Gruvlok flange adapter insert is designed for use with the Gruvlok 7012 & 7013. The flange adapter is required when mating the Gruvlok 7012 & 7013 to a rubber line valve or serrated face flange surface. The flange adapter ring is used in combination with a rubber lined valve or flange gasket to provide a smooth sealing surface for the 7012 & 7013 flange gasket.

- Introduction
- Couplings
- Outlets
- Fittings
- Valves & Accessories
- High Pressure
- CTS Copper System
- DI-Electric Nipples
- Plain-End Fittings
- HDPE Couplings
- Sock-It® Fittings
- Stainless Steel Method
- Roll Groovers
- Installation & Assembly
- Special Coatings
- Design Services
- Technical Data
- Master Format 3 Part Specs.
- Pictorial Index

Flange Adapter Inserts for use with Fig. 7012/7013 Flanges Flanged Seal Rings

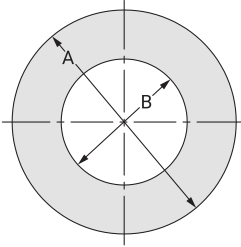

Nominal Size	O.D.	Fig. 7012 ANSI			Fig. 7012 PN 10/16		Fig. 7013 ANSI	
		A	B	PN	A	B	A	B
In./DN(mm)	In./mm	In./mm	In./mm	–	In./mm	In./mm	In./mm	In./mm
2	2.375	4	2¼	10/16	4 ¹¹ / ₆₄	2¼	4½	2¼
50	60.3	102	57		106	57	105	57
2½	2.875	4¾	2¾	–	–	–	5	2¾
65	73.0	121	70	–	–	–	127	70
3 O.D.	2.996	–	–	10/16	4 ³¹ / ₃₂	2 ⁷ / ₈	–	–
76.1	76.1	–	–		126	73	–	–
3	3.500	5¼	3⅝	10/16	5 ³⁹ / ₆₄	3⅝	5¾	3⅝
88.9	88.9	133	86		141	89	146	86
4	4.500	6¾	4⅝	10/16	6 ¹¹ / ₃₂	4⅝	7	4⅝
100	114.3	171	111		161	111	178	111
5½ O.D.	5.500	–	–	10/16	8 ³⁹ / ₆₄	5⅝	–	–
139.7	139.7	–	–		191	137	–	–
5	5.563	7⅝	5 ⁷ / ₁₆	–	–	–	8⅝	5 ⁷ / ₁₆
125	141.3	194	138	–	–	–	213	138
6½ O.D.	6.500	–	–	10/16	8 ³⁹ / ₆₄	6⅝	–	–
165.1	165.1	–	–		216	162	–	–
6	6.625	8⅝	6½	10/16	8 ³⁹ / ₆₄	6⅝	9¾	6½
150	168.3	219	165		216	162	248	165
8	8.625	10 ⁷ / ₈	8½	10/16	10 ²⁹ / ₃₂	8½	12	8½
200	219.1	276	216		272	216	305	216
10	10.750	13¼	10 ⁵ / ₈	10/16	12 ⁷ / ₈	10 ⁵ / ₈	14 ¹ / ₈	8½
250	273.1	337	270		327	270	359	216
12	12.750	16	12 ⁵ / ₈	–	–	–	16½	8½
300	323.9	406	321	–	–	–	419	216
12 (PN10)	12.750	–	–	10	14 ²⁷ / ₃₂	12 ⁵ / ₈	–	–
300	323.9	–	–		377	321	–	–
12 (PN16)	12.750	–	–	16	15 ⁵ / ₆₄	12 ⁵ / ₈	–	–
300	323.9	–	–		383	321	–	–
14	14.000	17 ⁵ / ₈	13¾	–	–	–	–	–
350	355.6	448	349	–	–	–	–	–
16	16.000	20 ¹ / ₈	15¾	–	–	–	–	–
400	406.4	511	400	–	–	–	–	–
18	18.000	21½	17¾	–	–	–	–	–
450	457.2	546	451	–	–	–	–	–
20	20.000	23¾	19¾	–	–	–	–	–
500	508.0	603	502	–	–	–	–	–
24	24.000	28 ¹ / ₈	23¾	–	–	–	–	–
600	609.6	714	603	–	–	–	–	–

Note:

HDPE Pipe Dimensions per ASTM F714, ASTM D2447, and ASTM D3035.

Expansion Joints Fig. 7240

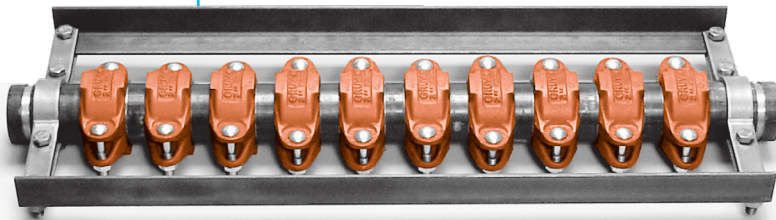

The Gruvlok Figure 7240 Expansion Joints take advantage of the axial expansion capabilities of the Gruvlok flexible couplings to produce a reliable grooved end expansion joint. The expansion joints are comprised of the Gruvlok Figure 7000 or 7001 flexible couplings and precision machined grooved end pipe nipples.

Ties are used to custom preset the expansion joints in the expanded, compressed or intermediate position to provide for the desired expansion and/or contraction compensation.

Installation is easy, simply follow the Gruvlok coupling installation and assembly instructions to install the expansion joint in the system and after installation is complete, remove the ties.

The expansion joints can be used as flexible connectors, however, they will not simultaneously provide for full axial expansion and angular deflection. Expansion joints require pipe anchoring capable of restraining the maximum system pressure end load.

Note: Expansion joint shown with shipping support. Contact an ASC Engineered Solutions™ representative for proper installation support requirements.

The service conditions are the same as the service conditions for coupling and gasket used in the expansions joint. Unless otherwise requested, this product will contain a silicone based lubricant. Refer to the Gruvlok catalog for coupling performance capabilities and material specifications. To order please provide the order form on the last page.

Note: The Gruvlok Figure 7240 Expansion Joint is also available in stainless steel.

- Introduction
- Couplings
- Outlets
- Fittings
- Valves & Accessories
- High Pressure
- CTS Copper System
- D-I-Electric Nipples
- Plain-End Fittings
- HDPE Couplings
- Sock-It® Fittings
- Stainless Steel Method
- Roll Groovers
- Installation & Assembly
- Special Coatings
- Design Services
- Technical Data
- Master Format 3 Part Specs.
- Pictorial Index

Expansion Joints Fig. 7240

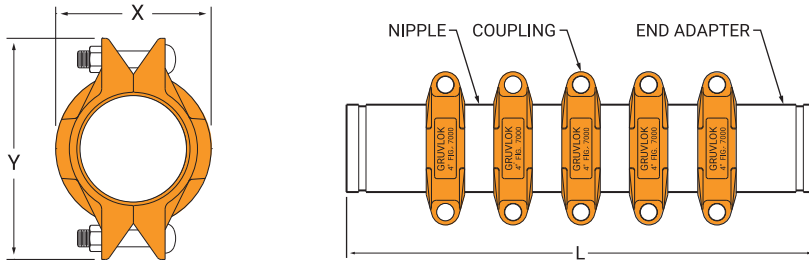

Performance Data (Inches)

Nominal Size	O.D.	Coupling Figure	X	Y	Compressed Length L	Expanded Length L	Coupling Movement Capability	Number of Couplings	Total Movement Capability
In./DN(mm)	In./mm		In./mm	In./mm	In./mm	In./mm	In./mm		In./mm
2 50	4.5 114.3	7000	3½ 89	5½ 125	30 762	31¼ 794	⅛ 3.2	10	1¼ 31.8
2½ 65	2.875 73.0	7000	4 100	5¾ 146	30 762	31¼ 794	⅛ 3.2	10	1¼ 31.8
3 80	3.5 88.9	7000	4⅝ 117	6¾ 171	30 762	31¼ 794	⅛ 3.2	10	1¼ 31.8
4 100	4.5 114.3	7000	5⅞ 149	8⅞ 206	17½ 445	18¾ 476	¼ 6.4	5	1¼ 31.8
5 125	5.562 141.3	7000	7 178	9⅝ 244	19 483	20¼ 514	¼ 6.4	5	1¼ 31.8
6 150	6.625 168.3	7000	8 200	11 279	19 483	20¼ 514	¼ 6.4	5	1¼ 31.8
8 200	8.625 219.0	7000	10½ 264	12 ¹³ / ₁₆ 337	22½ 572	23¾ 603	¼ 6.4	5	1¼ 31.8
10 250	10.75 273.1	7001	13⅞ 333	16⅝ 422	23½ 597	24¾ 629	¼ 6.4	5	1¼ 31.8
12 300	12.750 323.9	7001	15½ 394	18⅝ 433	23½ 597	24¾ 629	¼ 6.4	5	1¼ 31.8
14 350	14 355.6	7001	16⅞ 410	20½ 521	27 686	28½ 724	¼ 6.4	5	1¼ 31.8
16 400	16 406.4	7001-2	18 ¹⁵ / ₁₆ 465	22 558	27¾ 724	29 737	¼ 6.4	5	1¼ 31.8
18 450	18 457.2	7001-2	20¾ 527	24¼ 615	28½ 686	29¾ 756	¼ 6.4	5	1¼ 31.8
20 500	20 508	7001-2	23 582	27⅞ 691	28½ 724	29⅞ 765	¼ 6.4	5	1¼ 31.8
24 600	24 609.6	7001-2	27¼ 688	31⅞ 791	30½ 775	31¾ 807	¼ 6.4	5	1¼ 31.8

Expansion Joints Fig. 7240

Hanger Details

Vertical Support

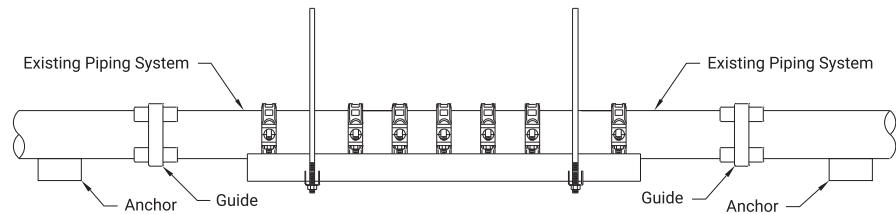
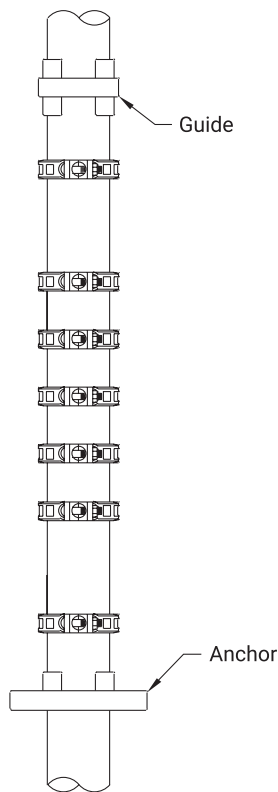

Horizontal Support

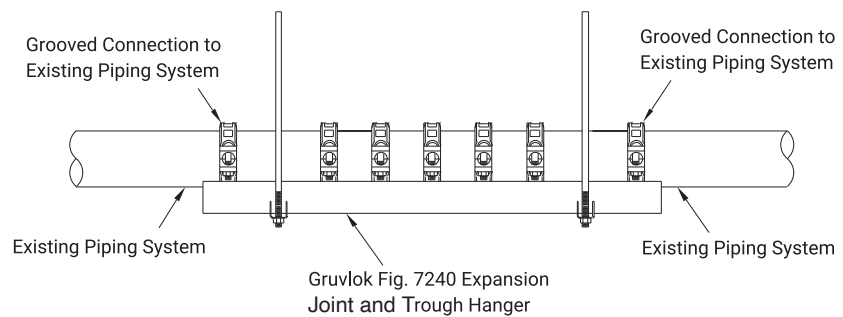

Trough and Hanger

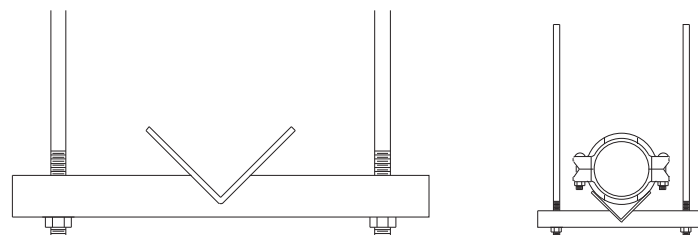
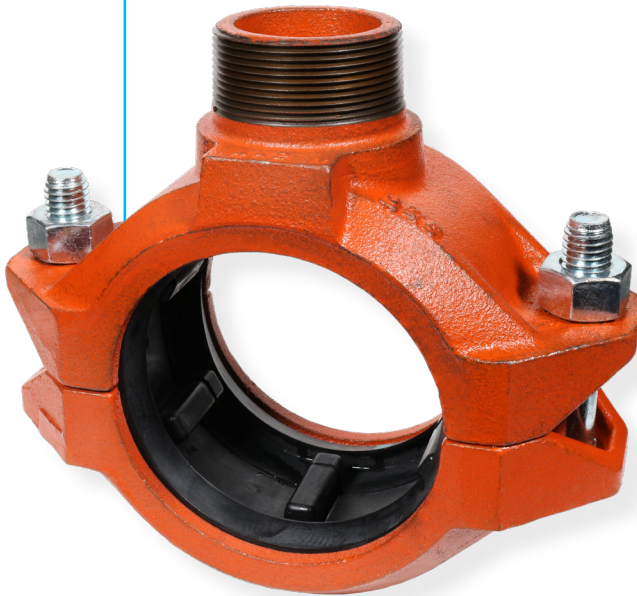

FIG. 7240 – ORDER FORM

When requesting a quotation or placing an order, please complete the following form.

1. Size and material of pipe to which the Expansion Joint will be connected: _____
2. Total overall movement capability: _____
3. Factory to preset the Expansion Joint to (select one): Full Expansion Full Contraction Intermediate _____
4. Pipe material for Expansion Joint (standard is sch. 40 steel): _____
5. Finish on pipe (standard is black): _____
6. Finish on couplings (standard is painted): _____
7. Gasket material (standard is Grade E EPDM): _____
8. Connecting pipe ends if different than standard roll or cut groove: _____
9. Are there any silicone restrictions for the application? Yes No _____

Outlet Coupling Fig. 7042



The Gruvlok Fig. 7042 Outlet Coupling is designed to join two sections of grooved end pipe and form a reducing outlet connection. The outlet couplings are available for the 1½" through 6" IPS or ISO run pipe sizes with the outlet pipe sizes ranging from ½" through 2".

Assembly of the coupling will create a gap between the pipe ends allowing the space required for the introduction of an outlet connection. The outlet connections are available grooved (Fig. 7042G), FPT (Fig. 7042F) and MPT (Fig. 7042M).

The gaskets are available in EPDM and Nitrile to suit a wide range of applications. The gasket design is a unique pressure responsive design that provides a higher sealing force as pressure is increased. The outlet gasket seal is reinforced by a steel ring and is mated to a machined housing surface to assure a leak-tight outlet seal. Center ribs inside the gasket ease positioning of the pipe during installation and provide additional support to the gasket. The outlet couplings are **NOT** recommended for vacuum applications or for use with beveled end pipe.

The Figure 7074 Cast Caps are NOT recommended for use on run connections. Contact an ASC Engineered Solutions™ Representative for additional details. Figure 7075 Bull Plugs must be used on end of line run connections. Figure 7074 Cast Caps may be used on Figure 7042G outlet connections. Flow into the outlet connection of the Figure 7042 Outlet Couplings must not exceed 7 ft./sec.

Material Specifications

Bolts

SAE J429, Grade 5, Zinc Electroplated
ISO 898-1, Class 8.8, Zinc Electroplated
followed by a Yellow Chromate Dip

Heavy Hex Nuts

ASTM A563, Grade A, Zinc Electroplated
ISO 898-2, Class 8.8, Zinc Electroplated
followed by a Yellow Chromate Dip

Stainless Steel Bolts & Nuts

304SS Stainless Steel bolts and nuts are available as a standard option.
(316SS are available for special order).

Housing

Ductile Iron conforming to ASTM A 536,
Grade 65-45-12.

Coatings

Rust inhibiting paint
Color: Orange (standard)
Hot Dipped Zinc Galvanized (optional)
Hot Dipped Zinc Galvanized (optional)

For other Coating requirements contact an ASC Engineered Solutions Representative.

Gasket Materials

Grade "E" EPDM (Green color code)

-40°F to 230°F (Service Temperature Range)
(-40°C to 110°C)

Recommended for water service, diluted acids, alkalies solutions, oil-free air and many other chemical services.

NOT FOR USE IN PETROLEUM APPLICATIONS.

Grade "T" Nitrile (Orange color code)

-20°F to 180°F (Service Temperature Range)
(-29°C to 82°C)

Recommended for petroleum applications. air with oil vapor and vegetable and mineral oils.

NOT FOR USE IN HOT WATER OR HOT AIR.

Lubrication

Standard Gruvlok
Gruvlok Xtreme (Do Not use with Grade "L")

Outlet Coupling Fig. 7042

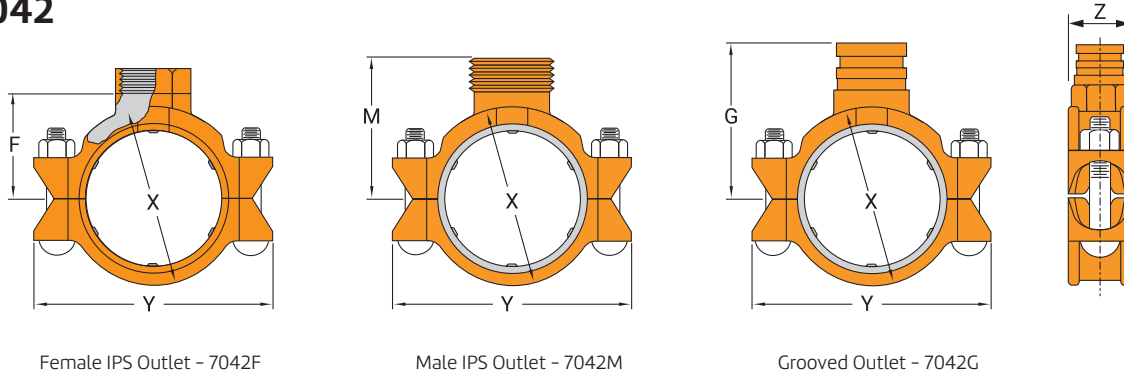

Run	Nominal Pipe Size		Working Pressure	Max. Run End Load	Range of Pipe End Separation	Coupling Dimensions						Bolt Size	Approx. Wt. Each
	FPT F	MPT/Grv. M/G				X	Y	Z	FPT F	MPT M	Grv. G		
In./DN(mm)	In./mm	In./mm	PSI/bar	Lbs./kN	In./mm	In./mm	In./mm	In./mm	In./mm	In./mm	In./mm	In./mm	Lbs./kg
	1/2	—	500	1418	3/4-1 1/16	2 15/16	4 3/4	2 3/4	2 1/16	—	—	3/8 x 2 1/8	2.6
	15	—	34.5	6.31	19-27	75	121	70	52	—	—	—	1.2
1 1/2	3/4	—	500	1418	3/4-1 1/16	2 15/16	4 3/4	2 3/4	2 1/16	—	—	3/8 x 2 1/8	2.6
	20	—	34.5	6.31	19-27	75	121	70	52	—	—	—	1.2
40	1	—	500	1418	3/4-1 1/16	2 15/16	4 3/4	2 3/4	1 15/16	—	—	3/8 x 2 1/8	2.9
	25	—	34.5	6.31	19-27	75	121	70	49	—	—	—	1.3
	1/2	—	500	2215	1 1/16-1	3 7/16	5 1/4	2 3/4	2 5/16	—	—	3/8 x 2 1/8	3.1
	15.0	—	34.5	9.85	17-25	87	133	70	59	—	—	—	1.4
2	3/4	—	500	2215	1 1/16-1	3 7/16	5 1/4	2 3/4	2 5/16	—	—	3/8 x 2 1/8	3.1
	20	—	34.5	9.85	17-25	87	133	70	59	—	—	—	1.4
50	1	1	500	2215	1 1/16-1	3 7/16	5 1/4	2 3/4	2 3/16	2 7/8	3 1/2	3/8 x 2 1/8	3.3
	25	25	34.5	9.85	17-25	87	133	70	56	73	89	—	1.5
	1/2	—	500	3246	1 3/16-1 1/2	4 3/16	6 1/2	3 1/4	2 9/16	—	—	1/2 x 2 3/8	4.8
	15	—	34.5	14.44	30-38	106	165	83	65	—	—	—	2.2
	3/4	—	500	3246	1 3/16-1 1/2	4 3/16	6 1/2	3 1/4	2 9/16	—	—	1/2 x 2 3/8	4.6
	20	—	34.5	14.44	30-38	106	165	83	65	—	—	—	2.1
2 1/2	1	—	500	3246	1 3/16-1 1/2	4 3/16	6 1/2	3 1/4	2 7/16	—	—	1/2 x 2 3/8	4.4
	25	—	34.5	14.44	30-38	106	165	83	62	—	—	—	2.2
65	—	1 1/4	500	3246	1 3/16-1 1/2	4 3/16	6 1/2	3 1/4	—	3 5/8	3 5/8	1/2 x 2 3/8	5.1
	—	32	34.5	14.44	30-38	106	165	83	—	92	92	—	2.3
	—	1 1/2	500	3246	1 3/16-1 1/2	4 3/16	6 1/2	3 1/4	—	3 5/8	3 5/8	1/2 x 2 3/8	5.9
	—	40	34.5	14.44	30-38	106	165	83	—	92	92	—	2.4

Note:

Pipe ends must be prepared in accordance with Gruvlok "Roll or Cut Groove Specifications for Steel and Other IPS or ISO size Pipe". Not recommended on beveled pipe. Pressure and end load ratings are for use with standard wall steel pipe.

For a one-time field test only, the maximum working pressure may be increased 1 1/2 times the figure shown.

For additional details see "Coupling Data Chart Notes" in the Introduction Section of the Gruvlok Catalog.

See Installation & Assembly directions in the Technical Data Section of the Gruvlok Catalog.

Not for use in copper systems.

Outlet Coupling Fig. 7042

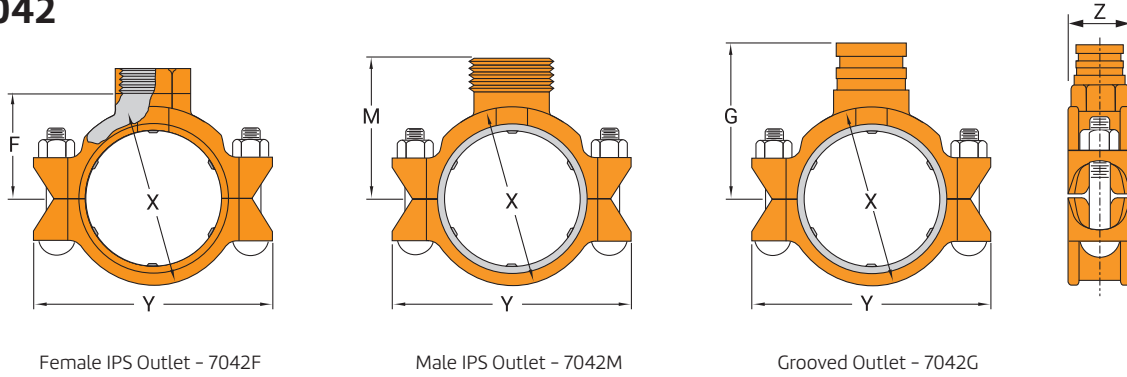

Run	Nominal Pipe Size		Working Pressure	Max. Run End Load	Range of Pipe End Separation	Coupling Dimensions						Bolt Size	Approx. Wt. Each
	Outlet					X	Y	Z	FPT F	MPT M	Grv. G		
	FPT F	MPT/Grv. M/G											
In./DN(mm)	In./mm	In./mm	PSI/bar	Lbs./kN	In./mm	In./mm	In./mm	In./mm	In./mm	In./mm	In./mm	In./mm	Lbs./kg
3 80	¾	—	500	4811	1 ¾-1 ½	4 ¾	7 ¼	3 ¼	2 13/16	—	—	½ x 3	5.9
	20	—	34.5	21.40	30-38	121	184	83	72	—	—	—	2.7
	1	1	500	4811	1 ¾-1 ½	4 ¾	7 ¼	3 ¼	2 ¾	3 ¾	4	½ x 3	6.2
	25	25	34.5	21.40	30-38	121	184	83	70	86	102	—	2.8
4 100	—	1 ½	500	4811	1 ¾-1 ½	4 ¾	7 ¼	3 ¼	—	4	4	½ x 3	6.4
	—	40	34.5	21.40	30-38	121	184	83	—	102	102	—	2.9
	¾	—	500	7952	1 ¾-1 7/8	6 ¾	8 7/8	3 5/8	3 11/16	—	—	5/8 x 3 ½	9.2
	20	—	34.5	35.37	40-48	157	225	92	94	—	—	—	4.2
6 150	1	—	500	7952	1 ¾-1 7/8	6 ¾	8 7/8	3 5/8	3 9/16	—	—	5/8 x 3 ½	9.5
	25	—	34.5	35.37	40-48	157	225	92	91	—	—	—	4.3
	—	1 ½	500	7952	1 ¾-1 7/8	6 ¾	8 7/8	3 5/8	—	4 7/8	4 7/8	5/8 x 3 ½	9.5
	—	40	34.5	35.37	40-48	157	225	92	—	124	124	—	4.3
6 150	—	2	500	7952	1 ¾-1 7/8	6 ¾	8 7/8	3 5/8	—	4 7/8	4 7/8	5/8 x 3 ½	9.9
	—	50	34.5	35.37	40-48	157	225	92	—	124	124	—	4.5
	1	—	500	17236	1 5/8-1 15/16	8 1/8	11 ¼	3 11/16	4 ¾	—	—	5/8 x 3 ½	13.2
	25	—	34.5	76.66	41-51	206	286	94	121	—	—	—	6.0
6 150	1 ½	1 ½	500	17236	1 5/8-1 15/16	8 1/8	11 ¼	3 11/16	4 ¾	6	6	5/8 x 3 ½	13.6
	40	40	34.5	76.66	41-51	206	286	94	121	154	152	—	6.2
6 150	—	2	500	17236	1 5/8-1 15/16	8 1/8	11 ¼	3 11/16	—	6	6	5/8 x 3 ½	14.3
	—	50	34.5	76.66	41-51	206	286	94	—	154	152	—	6.5

Note:

Pipe ends must be prepared in accordance with Gruvlok "Roll or Cut Groove Specifications for Steel and Other IPS or ISO size Pipe". Not recommended on beveled pipe. Pressure and end load ratings are for use with standard wall steel pipe.

For a one-time field test only, the maximum working pressure may be increased 1 ½ times the figure shown.

For additional details see "Coupling Data Chart Notes" in the Introduction Section of the Gruvlok Catalog.

See Installation & Assembly directions in the Technical Data Section of the Gruvlok Catalog.

Not for use in copper systems.

Clamp-T, FPT Branch Fig. 7045

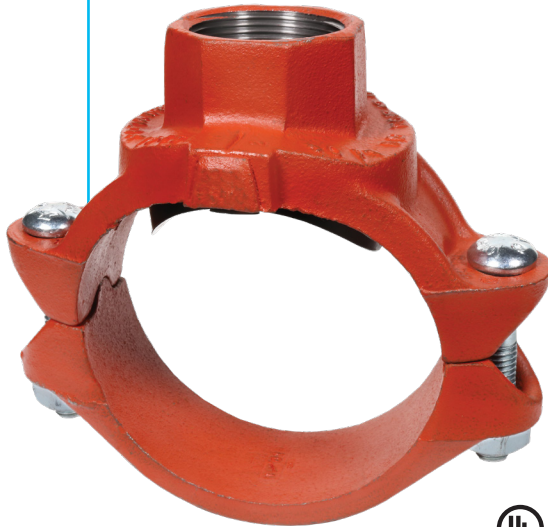

The Gruvlok Clamp-T provides a quick and easy outlet at any location along the pipe. A hole drilled or cut in the pipe to receive the locating collar of the Clamp-T is all that is required. The full, smooth outlet area provides for optimum flow characteristics.

The Clamp-T housing is specially engineered to conform to the pipe O.D. and the Clamp-T gasket providing a leak tight reliable seal in both positive pressure and vacuum conditions. The maximum working pressure for all sizes is 500 PSI (34.5 bar) when assembled on standard wall steel pipe.

The Gruvlok Clamp-T provides for a branch or cross connection in light wall or standard wall steel pipe.

The Fig. 7045 Clamp-T female pipe thread branch is available with NPT or ISO 7/1 connection and the Fig. 7046 Clamp-T has grooved-end branch connection.

Clamp-T cross connections are available in various sizes allowing greater versatility in piping design.

Note: Variable End Configurations are Possible — Thd x Thd and Gr. x Thd.

Sizes — 2" x 1/2" through 8" x 4"

For Listings/Approval Details and Limitations, visit our website at www.asc-es.com or contact an ASC Engineered Solutions™ Sales Representative.

Clamp-T Flow Data (Frictional Resistance)

Branch Size Inches	Fig. 7045 Threaded Branch	
	C.V. Value	Equiv. Pipe Length Feet
DN/mm	Meters	
1/2	22	1.0
15	—	0.3
3/4	25	2.0
20	—	0.6
1	44	2.0
25	—	0.6
1 1/4	76	2.5
32	—	0.8
1 1/2	89	4.0
40	—	1.2
2	164	3.5
50	—	1.1
2 1/2	152	12.5
65	—	3.8
3	318	8.5
80	—	2.6
4	536	8.0
100	—	2.4

Material Specifications

Bolts

SAE J429, Grade 5, Zinc Electroplated
ISO 898-1, Class 8.8, Zinc Electroplated followed by a Yellow Chromate Dip

Heavy Hex Nuts

ASTM A563, Grade A, Zinc Electroplated
ISO 898-2, Class 8.8, Zinc Electroplated followed by a Yellow Chromate Dip

U-Bolt

Cold drawn steel and zinc plated.

Housing

Ductile Iron conforming to ASTM A 536, Grade 65-45-12

Coatings

Rust inhibiting paint
Color: Orange (standard)
Hot Dipped Zinc Galvanized (optional)
Other Colors Available
(IE: RAL3000 and RAL9000)

For other Coating requirements Contact an ASC Representative for more information.

Gasket Materials

Properties as designated in accordance with ASTM D2000

Grade "E" EPDM (Green color code)

-40°F to 230°F (Service Temperature Range)
(-40°C to 110°C)

Recommended for water service, diluted acids, alkalis solutions, oil-free air and many other chemical services.

NOT FOR USE IN PETROLEUM APPLICATIONS.

Grade "T" Nitrile (Orange color code)

-20°F to 180°F (Service Temperature Range)
(-29°C to 82°C)

Recommended for petroleum applications, air with oil vapors and vegetable and mineral oils.
NOT FOR USE IN HOT WATER OR HOT AIR.

Lubrication

Standard Gruvlok

Gruvlok Xtreme (Do Not use with Grade "L")

Clamp-T, FPT Branch Fig. 7045

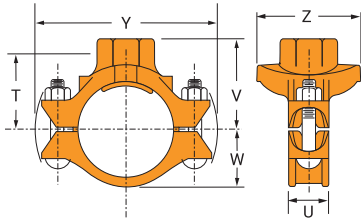

Fig. 7045

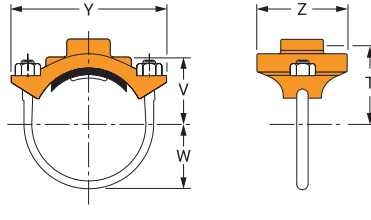

Fig. 7045 (U-Bolt)

Nominal Size	O.D.	Hole Dimensions		▼Max. Working Pressure	Clamp-T Dimensions						Bolt Size	Specified Torque §		Approx. Wt. Each
		Min. Diam.	Max. Diam.		T	U	V Threaded	W	Y	Z		Min.	Max.	
In./DN(mm)	In./mm	In./mm	In./mm	PSI/bar	In./mm	In./mm	In./mm	In./mm	In./mm	In./mm	In./mm	Ft.-Lbs/N-m	Ft.-Lbs/N-m	Lbs./kg
2 x 1/2 50 x 15	2.375 x 0.840 60.3 x 21.3	1 1/2 38	1 5/8 41	500 34.5	2 3/16 56	9/16 14	2 5/8 67	1/2 12	5 1/2 140	3 76	1/2 U-Bolt —	30	40	2.3 1.0
2 x 3/4 50 x 20	2.375 x 1.050 60.3 x 26.7	1 1/2 38	1 5/8 41	500 34.5	2 1/16 52	9/16 14	2 5/8 67	1 1/2 38	5 1/2 140	3 76	1/2 U-Bolt —	30	40	2.3 1.0
2 x 1 50 x 25	2.375 x 1.315 60.3 x 33.7	1 1/2 38	1 5/8 41	500 34.5	1 15/16 51	9/16 14	2 5/8 67	1 1/2 38	5 1/2 140	3 76	1/2 U-Bolt —	30	40	2.6 1.2
2 x 1 1/4 50 x 32	2.375 x 1.660 60.3 x 42.4	2 51	2 1/8 54	500 34.5	2 3/16 55	9/16 14	2 7/8 73	1 1/2 38	5 1/2 140	3 1/2 89	1/2 U-Bolt —	30	40	2.7 1.2
2 x 1 1/2 50 x 40	2.375 x 1.900 60.3 x 48.3	2 51	2 1/8 54	500 34.5	2 3/16 55	9/16 14	2 7/8 73	1 1/2 38	7 178	3 1/2 89	1/2 U-Bolt —	30	40	2.5 1.1
2 1/2 x 1/2 65 x 15	2.875 x 0.840 73.0 x 21.3	1 1/2 38	1 5/8 41	500 34.5	2 7/16 62	9/16 14	2 7/8 73	1 3/4 44	5 1/2 140	3 76	1/2 U-Bolt —	30	40	3.0 1.4
2 1/2 x 3/4 65 x 20	2.875 x 1.050 73.0 x 26.7	1 1/2 38	1 5/8 41	500 34.5	2 5/16 59	9/16 14	2 7/8 73	1 3/4 44	5 1/2 140	3 76	1/2 U-Bolt —	30	40	2.9 1.3
2 1/2 x 1 65 x 25	2.875 x 1.315 73.0 x 33.7	1 1/2 38	1 5/8 41	500 34.5	2 3/16 55	9/16 14	2 7/8 73	1 3/4 44	6 1/8 156	3 76	1/2 U-Bolt —	30	40	2.9 1.3
2 1/2 x 1 1/4 65 x 32	2.875 x 1.660 73.0 x 42.4	2 51	2 1/8 54	500 34.5	2 7/16 62	9/16 14	3 1/8 79	1 3/4 44	6 1/8 156	3 3/8 86	1/2 U-Bolt —	30	40	3.4 1.5
2 1/2 x 1 1/2 65 x 40	2.875 x 1.900 73.0 x 48.3	2 51	2 1/8 54	500 34.5	2 7/16 62	9/16 14	3 1/8 79	1 3/4 44	6 1/8 156	3 3/8 86	1/2 U-Bolt —	30	40	3.4 1.5
3 x 1/2 80 x 15	3.500 x 0.840 88.9 x 21.3	1 1/2 38	1 5/8 41	500 34.5	2 9/16 65	9/16 14	3 76	2 1/8 54	7 178	3 3/4 95	1/2 U-Bolt —	30	40	2.8 1.2
3 x 3/4 80 x 20	3.500 x 1.050 88.9 x 26.7	1 1/2 38	1 5/8 41	500 34.5	2 7/16 62	9/16 14	3 76	2 1/8 54	7 178	3 3/4 95	1/2 U-Bolt —	30	40	2.7 1.2
3 x 1 80 x 25	3.500 x 1.315 88.9 x 33.7	1 1/2 38	1 5/8 41	500 34.5	2 5/16 59	9/16 14	3 76	2 1/8 54	7 178	3 3/4 95	1/2 U-Bolt —	30	40	2.7 1.2

Note:

2 1/2", 5" and 6" Nom. Run pipe size Clamp-T may be used on 3" O.D., 5 1/2" O.D. and 6 1/2" O.D. pipe.

▼ Based on use with standard wall pipe.

§ - For additional Bolt Torque information, see the Technical Data Section of the Gruvlok Catalog.

See Installation & Assembly directions in the Technical Data Section of the Gruvlok Catalog.

Not for use with copper systems.

(Additional larger sizes on next page.)

Clamp-T, FPT Branch Fig. 7045

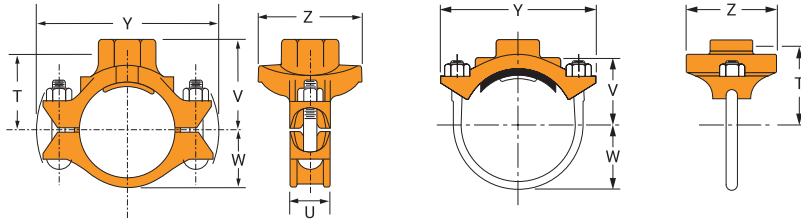

Fig. 7045

Fig. 7045 (U-Bolt)

Nominal Size	O.D.	Hole Dimensions		▼Max. Working Pressure	Clamp-T Dimensions						Specified Torque §		Approx. Wt. Each		
		Min. Diam.	Max. Diam.		T	U	V Threaded	W	Y	Z	Bolt Size	Min.		Max.	
In./DN(mm)	In./mm	In./mm	In./mm	PSI/bar	In./mm	In./mm	In./mm	In./mm	In./mm	In./mm	In./mm	In./mm	Ft.-Lbs/N-m	Ft.-Lbs/N-m	Lbs./kg
3 x 1¼ 80 x 32	3.500 x 1.660 88.9 x 42.4	2 51	2½ 54	500 34.5	2¹¹⁄₁₆ 68	1½ 38	3¾ 86	2½ 54	6⅞ 175	3¾ 95	½ x 2¾ —	80	100	3.4 1.5	
3 x 1½ 80 x 40	3.500 x 1.900 88.9 x 48.3	2 51	2½ 54	500 34.5	2¹¹⁄₁₆ 68	1½ 38	3¾ 86	2½ 54	6⅞ 175	3¾ 95	½ x 2¾ —	80	100	4.4 2.0	
3 x 2 80 x 50	3.500 x 2.375 88.9 x 60.3	2½ 64	2⅝ 67	500 34.5	2¹¹⁄₁₆ 68	1½ 38	3¾ 86	2½ 54	6⅞ 175	4⅞ 105	½ x 2¾ —	80	100	4.6 2.1	
4 x ½ 100 x 15	4.500 x 0.840 114.3 x 21.3	1½ 38	1⅝ 41	500 34.5	3¹⁄₁₆ 76	¾ 14	3½ 89	2⅝ 67	7¾ 197	3¾ 95	½ U-Bolt —	30	40	2.9 1.3	
4 x ¾ 100 x 20	4.500 x 1.050 114.3 x 26.7	1½ 38	1⅝ 41	500 34.5	3¹⁄₁₆ 78	¾ 14	3½ 89	2⅝ 67	7¾ 197	3¾ 95	½ U-Bolt —	30	40	2.8 1.3	
4 x 1 100 x 25	4.500 x 1.315 114.3 x 33.7	1½ 38	1⅝ 41	500 34.5	2¹³⁄₁₆ 73	¾ 14	3½ 89	2⅝ 67	7¾ 197	3¾ 95	½ U-Bolt —	30	40	2.7 1.2	
4 x 1¼ 100 x 32	4.500 x 1.660 114.3 x 42.4	2 51	2½ 54	500 34.5	3¹⁄₁₆ 81	1⅞ 48	3⅞ 98	2⅝ 67	7½ 191	3¾ 95	½ x 2¾ —	80	100	4.5 2.0	
4 x 1½ 100 x 40	4.500 x 1.900 114.3 x 48.3	2 51	2½ 54	500 34.5	3¹⁄₁₆ 81	1⅞ 48	3⅞ 98	2⅝ 67	7½ 191	3¾ 95	½ x 2¾ —	80	100	4.6 2.1	
4 x 2 100 x 50	4.500 x 2.375 114.3 x 60.3	2½ 64	2⅝ 67	500 34.5	3¹⁄₁₆ 84	1⅞ 48	4 102	2⅝ 67	7½ 191	4⅞ 105	½ x 2¾ —	80	100	7.7 3.5	
4 x 2½ 100 x 65	4.500 x 2.875 114.3 x 73.0	2¾ 70	2⅞ 73	500 34.5	3¹¹⁄₁₆ 78	1⅞ 48	4 102	2⅝ 67	7½ 191	4⅞ 111	½ x 2¾ —	80	100	5.2 2.4	
4 x 3 O.D. 100 x 80	4.500 x 2.996 114.3 x 76.1	2¾ 70	2⅞ 73	500 34.5	3 76	1⅞ 48	4 102	2⅝ 67	7½ 191	4⅞ 111	½ x 2¾ —	80	100	5.2 2.4	
4 x 3 100 x 80	4.500 x 3.500 114.3 x 88.9	3½ 89	3⅝ 92	500 34.5	3¼ 83	1⅞ 48	4¼ 108	2⅝ 67	7½ 191	5¼ 133	½ x 3½ —	80	100	6.5 2.9	

Note:

2½", 5" and 6" Nom. Run pipe size Clamp-T may be used on 3" O.D., 5½" O.D. and 6½" O.D. pipe.

▼ Based on use with standard wall pipe.

§ - For additional Bolt Torque information, see the Technical Data Section of the Gruvlok Catalog. See Installation & Assembly directions in the Technical Data Section of the Gruvlok Catalog. Not for use with copper systems.

(Additional smaller sizes on previous page and larger sizes on next page.)

Clamp-T, FPT Branch Fig. 7045

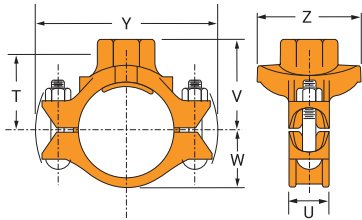

Fig. 7045

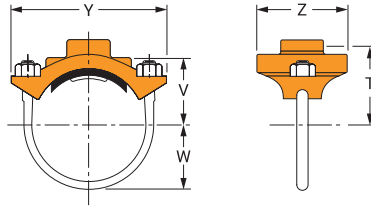

Fig. 7045 (U-Bolt)

Nominal Size	O.D.	Hole Dimensions		▼Max. Working Pressure	Clamp-T Dimensions						Specified Torque §		Approx. Wt. Each		
		Min. Diam.	Max. Diam.		T	U	V Threaded	W	Y	Z	Bolt Size	Min.		Max.	
In./DN(mm)	In./mm	In./mm	In./mm	PSI/bar	In./mm	In./mm	In./mm	In./mm	In./mm	In./mm	In./mm	In./mm	Ft.-Lbs/N-m	Ft.-Lbs/N-m	Lbs/kg
5 x 1 1/4 125 x 32	5.563 x 1.660 141.3 x 42.4	2 51	2 1/8 54	500 34.5	3 11/16 94	1 7/8 48	4 3/8 111	3 1/4 83	9 1/8 232	3 3/4 95	5/8 x 3 3/4 —	100	130	5.4 2.4	
5 x 1 1/2 125 x 40	5.563 x 1.900 141.3 x 48.3	2 51	2 1/8 54	500 34.5	3 11/16 94	1 7/8 48	4 3/8 111	3 1/4 83	9 1/8 232	3 3/4 95	5/8 x 3 3/4 —	100	130	5.5 2.5	
5 x 2 125 x 50	5.563 x 2.375 141.3 x 60.3	2 1/2 64	2 5/8 67	500 34.5	3 13/16 97	1 7/8 48	4 1/2 114	3 1/4 83	9 1/8 232	4 1/8 105	5/8 x 3 3/4 —	100	130	5.7 2.6	
5 x 2 1/2 125 x 65	5.563 x 2.875 141.3 x 73.0	2 3/4 70	2 7/8 73	500 34.5	3 13/16 97	1 7/8 48	4 3/4 121	3 1/4 83	9 1/8 232	4 3/8 111	5/8 x 3 3/4 —	100	130	7.0 3.2	
5 x 3 O.D. 125 x 80	5.563 x 2.996 141.3 x 76.1	2 3/4 70	2 7/8 73	500 34.5	3 3/4 95	7/8 48	4 3/4 121	3 1/4 83	9 1/8 232	4 3/8 111	5/8 x 3 3/4 —	130	180	7.0 3.2	
5 x 3 125 x 80	5.563 x 3.500 141.3 x 88.9	3 1/2 89	3 5/8 92	500 34.5	4 102	1 7/8 48	5 127	3 1/4 83	9 1/8 232	5 1/4 133	5/8 x 3 3/4 —	100	130	8.7 3.9	
6 x 1 1/4 150 x 32	6.625 x 1.660 168.3 x 42.4	2 51	2 1/8 54	500 34.5	4 3/16 106	2 51	4 7/8 124	3 7/8 98	10 1/8 257	3 3/4 95	5/8 x 4 1/4 —	100	130	7.8 3.5	
6 x 1 1/2 150 x 40	6.625 x 1.900 168.3 x 48.3	2 51	2 1/8 54	500 34.5	4 3/16 106	2 51	4 7/8 124	3 7/8 98	10 1/8 257	3 3/4 95	5/8 x 4 1/4 —	100	130	7.8 3.5	
6 x 2 150 x 50	6.625 x 2.375 168.3 x 60.3	2 1/2 64	2 5/8 67	500 34.5	4 3/16 106	2 51	4 7/8 124	3 7/8 98	10 1/8 257	4 1/8 105	5/8 x 4 1/4 —	100	130	7.8 3.5	
6 x 2 1/2 150 x 65	6.625 x 2.875 168.3 x 73.0	2 3/4 70	2 7/8 73	500 34.5	4 3/16 106	2 51	5 1/8 130	3 7/8 98	10 1/8 257	4 3/8 111	5/8 x 4 1/4 —	100	130	8.4 3.8	
6 x 3 O.D. 150 x 80	6.625 x 2.996 168.3 x 76.1	2 3/4 70	2 7/8 73	500 34.5	4 1/8 105	2 51	5 1/8 130	3 7/8 98	10 1/8 257	4 3/8 111	5/8 x 4 1/4 —	100	130	8.4 3.8	
6 x 3 150 x 80	6.625 x 3.500 168.3 x 88.9	3 1/2 89	3 5/8 92	500 34.5	4 3/8 111	2 51	5 3/8 137	3 7/8 98	10 1/8 257	5 1/4 133	5/8 x 4 1/4 —	100	130	9.6 4.4	
6 x 4 150 x 100	6.625 x 4.500 168.3 x 114.3	4 1/2 114	4 5/8 117	500 34.5	4 3/8 111	2 51	5 1/2 140	3 7/8 98	10 1/8 257	6 1/2 165	5/8 x 4 1/4 —	100	130	10.5 4.8	
8 x 2 200 x 50	8.625 x 2.750 219.1 x 70.0	2 1/2 64	2 5/8 67	500 34.5	5 3/16 132	2 1/4 57	5 7/8 149	5 127	12 3/4 324	4 1/8 105	3/4 x 4 1/4 —	130	180	11.3 5.1	
8 x 2 1/2 200 x 65	8.625 x 2.875 219.1 x 73.0	2 3/4 70	2 7/8 73	500 34.5	5 3/16 134	2 1/4 57	6 1/4 159	5 127	12 3/4 324	4 3/8 111	3/4 x 4 1/2 —	130	180	11.1 5.0	
8 x 3 O.D. 200 x 80	8.625 x 2.996 219.1 x 76.1	2 3/4 70	2 7/8 73	500 34.5	5 1/4 133	2 1/4 57	6 1/4 159	5 127	12 3/4 324	4 3/8 111	3/4 x 4 1/2 —	130	180	11.1 5.0	
8 x 3 200 x 80	8.625 x 3.500 219.1 x 88.9	3 1/2 89	3 5/8 92	500 34.5	5 3/8 137	2 1/4 57	6 3/8 162	5 127	12 3/4 324	5 1/4 133	3/4 x 4 1/2 —	130	180	13.0 5.9	
8 x 4 200 x 100	8.625 x 4.500 219.1 x 114.3	4 1/2 114	4 5/8 117	500 34.5	5 3/8 137	2 1/4 57	6 1/2 165	5 127	12 3/4 324	6 1/2 165	3/4 x 4 1/2 —	130	180	16.2 7.3	

Note:

2 1/2", 5" and 6" Nom. Run pipe size Clamp-T may be used on 3" O.D., 5 1/2" O.D. and 6 1/2" O.D. pipe.

▼ Based on use with standard wall pipe.

§ - For additional Bolt Torque information, see the Technical Data Section of the Gruvlok Catalog. See Installation & Assembly directions in the Technical Data Section of the Gruvlok Catalog.

Not for use with copper systems.

(Additional smaller sizes on previous page.)

Clamp-T, Grooved Branch Fig. 7046



The Gruvlok Clamp-T provides a quick and easy outlet at any location along the pipe. A hole drilled or cut in the pipe to receive the locating collar of the Clamp-T is all that is required. The full, smooth outlet area provides for optimum flow characteristics.

The Clamp-T housing is specially engineered to conform to the pipe O.D. and the Clamp-T gasket providing a leak-tight reliable seal in both positive pressure and vacuum conditions. The maximum working pressure for all sizes is 500 PSI (34.5 bar) when assembled on standard wall steel pipe.

The Gruvlok Clamp-T provides for a branch or cross connection in light wall or standard wall steel pipe.

Clamp-T cross connections are available in most sizes allowing greater versatility in piping design.

For Listings/Approval Details and Limitations, visit our website at www.asc-es.com or contact an ASC Engineered Solutions™ Sales Representative.

Clamp-T Flow Data (Frictional Resistance)

Branch Size	Fig. 7046 Grooved Branch	
	C.V. Value	Equiv. Pipe Length
DN/mm		Meters
1 ¼ 32	5.4	5.0 1.5
1 ½ 40	95	3.5 1.1
2 50	148	4.5 1.4
2 ½ 65	205	7.0 2.1
3 80	294	9.5 2.9
4 100	571	7.0 2.1

Material Specifications

Bolts

SAE J429, Grade 5, Zinc Electroplated
ISO 898-1, Class 8.8, Zinc Electroplated followed by a Yellow Chromate Dip

Heavy Hex Nuts

ASTM A563, Grade A, Zinc Electroplated
ISO 898-2, Class 8.8, Zinc Electroplated followed by a Yellow Chromate Dip

U-Bolt

Cold drawn steel and zinc plated.

Housing

Ductile Iron conforming to ASTM A536, Grade 65-45-12

Coatings

Rust inhibiting paint
Color: Orange (standard)
Hot Dipped Zinc Galvanized (optional)
Other Colors Available
(IE: RAL3000 and RAL 9000)

For other Coating requirements contact an ASC Engineered Solutions™ Representative for more information.

Gasket Materials

Properties as designated in accordance with ASTM D2000

Grade "E" EPDM (Green color code)
-40°F to 230°F (Service Temperature Range)
(-40°C to 110°C)

Recommended for water service, diluted acids, alkalis solutions, oil-free air and many other chemical services.

NOT FOR USE IN PETROLEUM APPLICATIONS.

Grade "T" Nitrile (Orange color code)
-20°F to 180°F (Service Temperature Range)
(-29°C to 82°C)

Recommended for petroleum applications. Air with oil vapors and vegetable and mineral oils.
NOT FOR USE IN HOT WATER OR HOT AIR.

Lubrication

Standard Gruvlok
Gruvlok Xtreme (Do Not use with Grade "L")

- Introduction
- Couplings
- Outlets
- Fittings
- Valves & Accessories
- High Pressure
- CTS Copper System
- DI-Electric Nipples
- Plan-End Fittings
- HDPE Couplings
- Socket-Fittings
- Stainless Steel Method
- Roll Groovers
- Installation & Assembly
- Special Coatings
- Design Services
- Technical Data
- Master Format 3 Part Specs.
- Pictorial Index

Clamp-T, Grooved Branch Fig. 7046

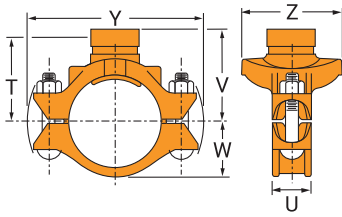

Fig. 7046

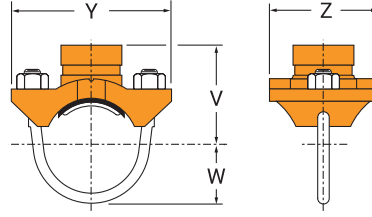

Fig. 7046 (U-Bolt)

Nominal Size	O.D.	Hole Dimensions		▼Max. Working Pressure	Clamp-T Dimensions					Bolt Size	Specified Torque §		Approx. Wt. Each
		Min. Diam.	Max. Diam.		U	V Grooved	W	Y	Z		Min.	Max.	
In./DN(mm)	In./mm	In./mm	In./mm	PSI/bar	In./mm	In./mm	In./mm	In./mm	In./mm	In./mm	Ft.-Lbs/N-m	Lbs./kg	
2½ x 1¼ 65 x 32	2.875 x 1.660 73.0 x 42.4	2 51	2⅝ 54	500 34.5	⅞ 14	3⅝ 79	1¾ 44	6⅝ 156	3½ 89	½ U-Bolt —	30 40	3.4 1.5	
2½ x 1½ 65 x 40	2.875 x 1.900 73.0 x 48.3	2 51	2⅝ 54	500 34.5	⅞ 14	3⅝ 79	1¾ 44	6⅝ 156	3½ 89	½ U-Bolt —	30 40	3.4 1.5	
3 x 1¼ 80 x 32	3.500 x 1.660 88.9 x 42.4	2 51	2⅝ 54	500 34.5	1½ 38	3½ 89	2⅝ 54	6⅞ 175	¾ 95	½ x 2¾ —	80 100	3.4 1.5	
3 x 1½ 80 x 40	3.500 x 1.900 88.9 x 48.3	2 51	2⅝ 54	500 34.5	1½ 38	3½ 89	2⅝ 54	6⅞ 175	¾ 95	½ x 2¾ —	80 100	4.4 2.0	
3 x 2 80 x 50	3.500 x 2.375 88.9 x 60.3	2½ 64	2⅝ 67	500 34.5	1½ 38	3½ 89	2⅝ 54	6⅞ 175	4⅝ 105	½ x 2¾ —	80 100	4.6 2.1	
4 x 1¼ 100 x 32	4.500 x 1.660 114.3 x 42.4	2 51	2⅝ 54	500 34.5	1⅞ 48	4 102	2⅝ 67	7½ 191	¾ 95	½ x 2¾ —	80 100	4.2 1.9	
4 x 1½ 100 x 40	4.500 x 1.900 114.3 x 48.3	2 51	2⅝ 54	500 34.5	1⅞ 48	4 102	2⅝ 67	7½ 191	¾ 95	½ x 2¾ —	80 100	4.3 2.0	
4 x 2 100 x 50	4.500 x 2.375 114.3 x 60.3	2½ 64	2⅝ 67	500 34.5	1⅞ 48	4 102	2⅝ 67	7½ 191	4⅝ 105	½ x 2¾ —	80 100	4.6 2.1	
4 x 2½ 100 x 65	4.500 x 2.875 114.3 x 73.0	¾ 70	2⅞ 73	500 34.5	1⅞ 48	4 102	2⅝ 67	7½ 191	4⅝ 111	½ x 2¾ —	80 100	5.0 2.3	
4 x 3 O.D. 100 x 80	4.500 x 2.996 114.3 x 76.1	¾ 70	2⅞ 73	500 34.5	1⅞ 48	4 102	2⅝ 67	7½ 191	4⅝ 111	½ x 2¾ —	80 100	5.0 2.3	
4 x 3 100 x 80	4.500 x 3.500 114.3 x 88.9	¾ 89	3⅝ 92	500 34.5	1⅞ 48	4 102	2⅝ 67	7½ 191	5¼ 133	½ x 3½ —	80 100	5.6 2.5	
5 x 1¼ 125 x 32	5.563 x 1.660 141.3 x 42.4	2 51	2⅝ 54	500 34.5	1⅞ 48	4¼ 108	3¼ 83	9⅝ 232	¾ 95	⅝ x 3¼ —	80 100	5.6 2.5	
5 x 1½ 125 x 40	5.563 x 1.900 141.3 x 48.3	2 51	2⅝ 54	500 34.5	1⅞ 48	4¼ 108	3¼ 83	9⅝ 232	¾ 95	⅝ x 3¼ —	100 130	5.6 2.5	
5 x 2 125 x 50	5.563 x 2.375 141.3 x 60.3	2½ 64	2⅝ 67	500 34.5	1⅞ 48	4¼ 108	3¼ 83	9⅝ 232	4⅝ 105	⅝ x 3¼ —	100 130	5.5 2.5	

Note:

2½", 5" and 6" Nom. Run pipe size Clamp-T may be used on 3" O.D., 5½" O.D. and 6½" O.D. pipe.

• Cannot be used in cross configuration.

▼ Based on use with standard wall pipe.

§ – For additional Bolt Torque information, see the Technical Data Section of the Gruvlok Catalog. See Installation & Assembly directions in the Technical Data Section of the Gruvlok Catalog.

Not for use with copper systems.

Clamp-T, Grooved Branch Fig. 7046

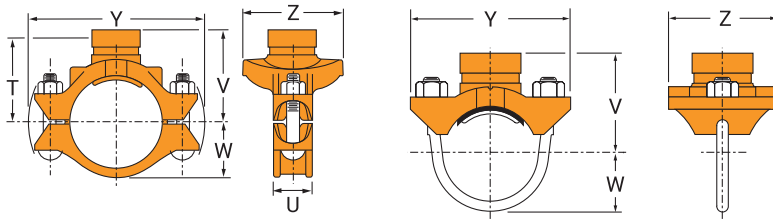

Fig. 7046

Fig. 7046 (U-Bolt)

Nominal Size	O.D.	Hole Dimensions		▼ Max. Working Pressure	Clamp-T Dimensions					Bolt Size	Specified Torque §		Approx. Wt. Each
		Min. Diam.	Max. Diam.		U	V Grooved	W	Y	Z		Min.	Max.	
In./DN(mm)	In./mm	In./mm	In./mm	PSI/bar	In./mm	In./mm	In./mm	In./mm	In./mm	In./mm	Ft.-Lbs/N-m	Lbs./kg	
5 x 2½ 125 x 65	5.563 x 2.875 141.3 x 73.0	2¾ 70	2⅞ 73	500 34.5	1⅞ 48	4¼ 108	3¼ 83	9⅞ 232	4⅞ 111	⅝ x 3¼ —	100	130	5.8 2.6
5 x 3 125 x 80	5.563 x 3.500 141.3 x 88.9	3½ 89	3⅝ 92	500 34.5	1⅞ 48	4⅝ 117	3¼ 83	9⅞ 232	5¼ 133	⅝ x 3¼ —	100	130	7.1 3.2
6 x 1¼ 150 x 32	6.625 x 1.660 168.3 x 42.4	2 51	2⅞ 54	500 34.5	2 51	5 127	3⅞ 98	10⅞ 257	3¾ 95	⅝ x 4¼ *	100	130	7.2 3.3
6 x 1½ 150 x 40	6.625 x 1.900 168.3 x 48.3	2 51	2⅞ 54	500 34.5	2 51	5 127	3⅞ 98	10⅞ 257	3¾ 95	⅝ x 4¼ *	100	130	7.2 3.3
6 x 2 150 x 50	6.625 x 2.375 168.3 x 60.3	2½ 64	2⅝ 67	500 34.5	2 51	5 127	3⅞ 98	10⅞ 257	4⅞ 105	⅝ x 4¼ *	100	130	7.8 3.5
6 x 2½ 150 x 65	6.625 x 2.875 168.3 x 73.0	2¾ 70	2⅞ 73	500 34.5	2 51	5⅞ 130	3⅞ 98	10⅞ 257	4⅞ 111	⅝ x 4¼ *	100	130	7.6 3.4
6 x 3 O.D. 150 x 80	6.625 x 2.996 168.3 x 76.1	2¾ 70	2⅞ 73	500 34.5	2 51	5⅞ 130	3⅞ 98	10⅞ 257	4⅞ 111	⅝ x 4¼ *	100	130	7.6 3.4
6 x 3 150 x 80	6.625 x 3.500 168.3 x 88.9	3½ 89	3⅝ 92	500 34.5	2 51	5⅞ 130	3⅞ 98	10⅞ 257	5¼ 133	⅝ x 4¼ *	100	130	8.0 3.6
6 x 4 150 x 100	6.625 x 4.500 168.3 x 114.3	4½ 114	4⅝ 117	500 34.5	2 51	5¼ 133	3⅞ 98	10⅞ 257	6½ 165	⅝ x 4¼ *	100	130	10.4 4.7
8 x 2 200 x 50	8.625 x 2.375 219.1 x 60.3	2½ 64	2⅝ 67	500 34.5	2¼ 57	6⅞ 156	5 127	12¾ 324	4¼ 108	¾ x 4½ —	130	180	10.4 4.7
8 x 2½ 200 x 65	8.625 x 2.875 219.1 x 73.0	2¾ 70	2⅞ 73	500 34.5	2¼ 57	6⅞ 156	5 127	12¾ 324	4⅞ 111	¾ x 4½ M20 x 110	130 175	180 245	10.6 4.8
8 x 3 200 x 80	8.625 x 3.500 219.1 x 88.9	3½ 89	3⅝ 92	500 34.5	2¼ 57	6⅞ 156	5 127	12¾ 324	5¼ 133	¾ x 4½ M20 x 110	130 175	180 245	11.5 5.2
8 x 4 200 x 100	8.625 x 4.500 219.1 x 114.3	4½ 114	4⅝ 117	500 34.5	2¼ 57	6¼ 159	5 127	12¾ 324	6½ 165	¾ x 4½ M20 x 110	130 175	180 245	16.2 7.3

Note:

- 2½", 5" and 6" Nom. Run pipe size Clamp-T may be used on 3" O.D., 5½" O.D. and 6½" O.D. pipe. (Additional larger sizes on next page.)
- Cannot be used in cross configuration.

▼ Based on use with standard wall pipe.

§ – For additional Bolt Torque information, see the Technical Data Section of the Gruvlok Catalog.

See Installation & Assembly directions in the Technical Data Section of the Gruvlok Catalog.

Not for use with copper systems.

Fig. 7047 Clamp-T Cross (Thread x Thread)
Fig. 7048 Clamp-T Cross (Groove x Groove)
Fig. 7049 Clamp-T Cross (Groove x Thread)

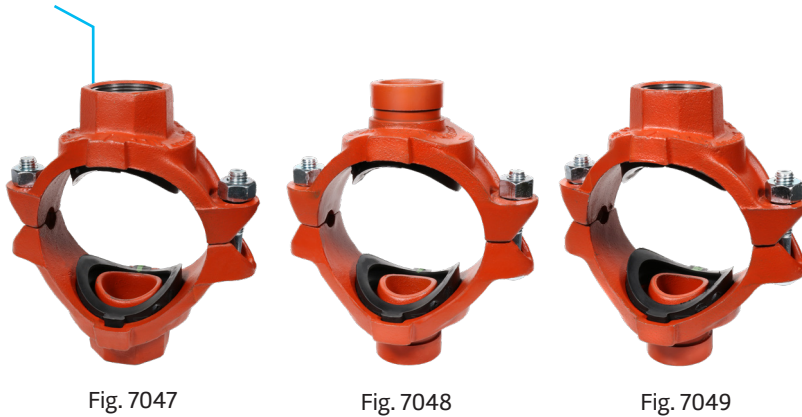

Material Specifications

Bolts

SAE J429, Grade 5, Zinc Electroplated
 ISO 898-1, Class 8.8, Zinc Electroplated
 followed by a Yellow Chromate Dip

Heavy Hex Nuts

ASTM A563, Grade A, Zinc Electroplated
 ISO 898-2, Class 8.8, Zinc Electroplated
 followed by a Yellow Chromate Dip

Housing

Ductile Iron conforming to ASTM A 536,
 Grade 65-45-12 or Malleable Iron conforming to
 ASTM A 47, Grade 32510.

Coatings

Rust inhibiting paint
 Color: Orange (standard)
 Hot Dipped Zinc Galvanized (optional)
 Other Colors Available
 (IE: RAL3000 and RAL9000)

For other Coating requirements contact an
 ASC Engineered Solutions™ Representative
 for more information.

Gasket Materials

Properties as designated in accordance with
 ASTM D2000

Grade "E" EPDM (Green color code)

-40°F to 230°F (Service Temperature Range)
 (-40°C to 110°C)

Recommended for water service, diluted acids,
 alkalis solutions, oil-free air and many other
 chemical services.

NOT FOR USE IN PETROLEUM APPLICATIONS.

Grade "T" Nitrile (Orange color code)

-20°F to 180°F (Service Temperature Range)
 (-29°C to 82°C)

Recommended for petroleum applications. air with
 oil vapors and vegetable and mineral oils.

NOT FOR USE IN HOT WATER OR HOT AIR.

Lubrication

Standard Gruvlok

Gruvlok Xtreme (Do Not use with Grade "L")

Not for use in copper systems.

The Gruvlok® Clamp-T provides a branch or cross connection in light wall
 or standard wall steel pipe.

The Fig. 7045 Clamp-T female pipe thread branch is available with NPT
 or ISO 7/1 connection and the Fig. 7046 Clamp-T has grooved-end
 branch connection.

Clamp-T cross connections are available allowing greater versatility
 in piping design.

NOTE: 2 1/2" x 1 1/4" Figure 7046 cannot be used in cross configuration.

For Listings/Approval Details and Limitations, visit our website at www.asc-es.com
 or contact an ASC Engineered Solutions™ Sales Representative.

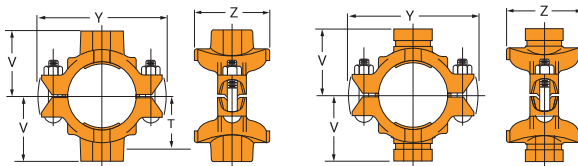

Fig. 7047 - Thread x Thread

Fig. 7048 - Groove x Groove

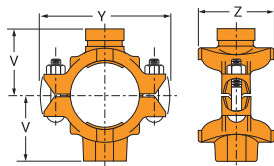
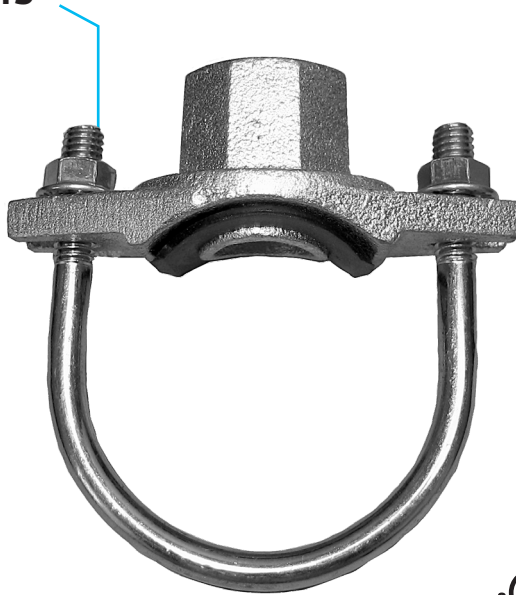

Fig. 7049 - Groove x Thread

Branch Outlet
Fig. 7043



The Gruvlok Figure 7043 Branch Outlet is for direct connection of sprinkler heads and drop nipples. Just cut a hole, saddle up and fasten it with the U-bolt. The branch outlet provides an economical, quick, and easy outlet at any location along a pipe. Specially engineered to conform to the pipe O.D., the Fig. 7043 provides a leak tight reliable seal in both positive pressure and vacuum conditions. Ductile iron housings with Grade E gasket and carbon steel U-bolt (3/8" dia.) with flanged nuts. Ductile iron housing is available painted or galvanized.

The maximum working pressure for all sizes is 175 PSI (12.1 bar).

For Listings/Approval Details and Limitations, visit our website at www.asc-es.com or contact an ASC Engineered Solutions™ Sales Representative.

Material Specifications

Gasket Materials

Properties as designated in accordance with ASTM D2000

Grade "E" EPDM (Green color code)

-40°F to 150°F (Service Temperature Range (-40°C to 66°C) Recommended for water service, diluted acids, alkalis solutions, oil-free air and many chemical services.

NOT FOR USE IN PETROLEUM APPLICATIONS.

Housing

Ductile Iron conforming to ASTM A536, Grade 65-45-12.

Coatings

Rust inhibiting paint

Color: Orange (standard)

Hot Dipped Zinc Galvanized (optional)

U-Bolt

Plated U-bolt conforming to ASTM A307 with plated hex nuts conforming to ASTM A563.

Lubrication

Standard Gruvlok

Gruvlok Xtreme

Introduction

Couplings

Outlets

Fittings

Valves & Accessories

High Pressure

CTS Copper System

DI-Electric Nipples

Plan-End Fittings

HDPE Couplings

Sock-It® Fittings

Stainless Steel Method

Roll Groovers

Installation & Assembly

Special Coatings

Design Services

Technical Data

Master Format 3 Part Specs.

Pictorial Index

Branch Outlet Fig. 7043

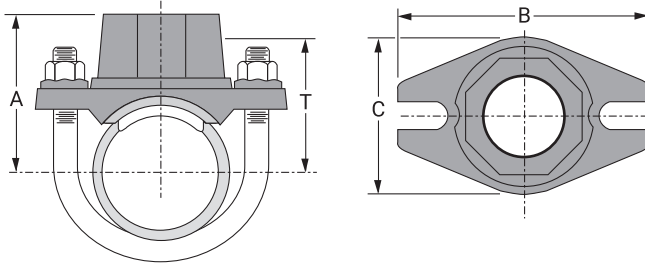

Nominal Size	O.D.	Home Diameter		Dimensions				Specified Torque §		Approx. Wt. Each
		Min. Dia.	Max. Dia.	A	B	C	Take-out T	Min.	Max.	
In./DN(mm)	In./mm	In./mm	In./mm	In./mm	In./mm	In./mm	In./mm	Ft.-Lbs./N-m		Lbs./kg
1¼ x ½ 32 x 15	1.660 x 0.840 42.4 x 21.3	1 ³ / ₁₆ 30	1¼ 32	2 ¹ / ₁₆ 53	3½ 89	2 ⁷ / ₃₂ 56	1 ³ / ₈ 35	27 —	33 —	0.8 0.4
1¼ x ¾ 32 x 20	1.660 x 1.050 42.4 x 26.7	1 ³ / ₁₆ 30	1¼ 32	2 ¹ / ₁₆ 53	3½ 89	2 ⁷ / ₃₂ 56	1 ³ / ₈ 35	27 —	33 —	0.8 0.4
1¼ x 1 32 x 25	1.660 x 1.315 42.4 x 33.7	1 ³ / ₁₆ 30	1¼ 32	2 ³ / ₁₆ 56	3½ 89	2 ⁷ / ₃₂ 56	1½ 38	27 —	33 —	0.9 0.4
1½ x ½ 40 x 15	1.900 x 0.840 48.3 x 21.3	1 ³ / ₁₆ 30	1¼ 32	2 ⁵ / ₃₂ 55	3½ 89	2 ⁷ / ₃₂ 56	1 ³ / ₈ 35	27 —	33 —	0.8 0.4
1½ x ¾ 40 x 20	1.900 x 1.050 48.3 x 26.7	1 ³ / ₁₆ 30	1¼ 32	2 ⁵ / ₃₂ 55	3½ 89	2 ⁷ / ₃₂ 56	1 ³ / ₈ 35	27 —	33 —	0.8 0.4
1½ x 1 40 x 25	1.900 x 1.315 48.3 x 33.7	1 ³ / ₁₆ 30	1¼ 32	2 ⁹ / ₃₂ 58	3½ 89	2 ⁷ / ₃₂ 56	1½ 38	27 —	33 —	0.9 0.4
2 x ½ 50 x 15	2.375 x 0.840 60.3 x 21.3	1 ³ / ₁₆ 30	1¼ 32	2½ 64	3 ⁷ / ₈ 98	2 ⁷ / ₃₂ 56	1 ⁵ / ₈ 42	27 —	33 —	0.8 0.4
2 x ¾ 50 x 20	2.375 x 1.050 60.3 x 26.7	1 ³ / ₁₆ 30	1¼ 32	2½ 64	3 ⁷ / ₈ 98	2 ⁷ / ₃₂ 56	1 ⁵ / ₈ 42	27 —	33 —	0.8 0.4
2 x 1 50 x 25	2.375 x 1.315 60.3 x 33.7	1 ³ / ₁₆ 30	1¼ 32	2 ⁵ / ₈ 67	3 ⁷ / ₈ 98	2 ⁷ / ₃₂ 56	1¾ 45	27 —	33 —	0.9 0.4
2½ x ½ 65 x 15	2.875 x 0.840 73.0 x 21.3	1 ³ / ₁₆ 30	1¼ 32	2 ¹¹ / ₁₆ 69	4 ³ / ₈ 111	2 ⁷ / ₃₂ 56	2 51	27 —	33 —	0.8 0.4
2½ x ¾ 65 x 20	2.875 x 1.050 73.0 x 26.7	1 ³ / ₁₆ 30	1¼ 32	2 ¹¹ / ₁₆ 69	4 ³ / ₈ 111	2 ⁷ / ₃₂ 56	2 51	27 —	33 —	0.9 0.4
2½ x 1 65 x 25	2.875 x 1.315 73.0 x 33.7	1 ³ / ₁₆ 30	1¼ 32	2 ¹³ / ₁₆ 72	4 ³ / ₈ 111	2 ⁷ / ₃₂ 56	2½ 54	27 —	33 —	1.0 0.5

Note:

§ – For additional Bolt Torque information, see page 204.

See Installation & Assembly directions in the Technical Data Section of the Gruvlok Catalog.

Not for use with copper systems.

Fig. 7050 90° Elbow
Fig. 7051 45° Elbow
Fig. 7052 22½° Elbow

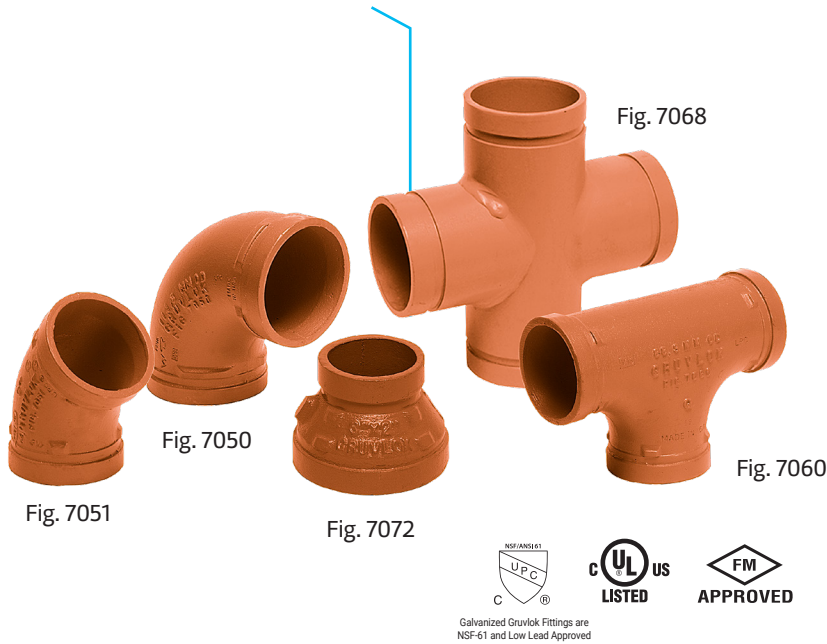

Material Specifications

Cast Fittings

Ductile iron conforming to ASTM A536, Grade 65-45-12

Malleable iron conforming to ASTM A47

Fabricated Fittings

1-12" Carbon steel, Schedule 40, conforming to ASTM A53, Grade B

14-24" Carbon steel, 0.375 wall, conforming to ASTM A53, Grade B

Coatings

Rust inhibiting paint
 Color: Orange (standard)

Hot Dipped Zinc Galvanized conforming to ASTM A153 (optional)

Other Colors Available
 (IE: RAL3000 and RAL9000)

Gruvlok fittings are available through 24" nominal pipe size in a variety of styles. Use the Fitting Size Table to convert nominal pipe size to corresponding pipe O.D.

These fittings are designed to provide minimum pressure drop and uniform strength.

Depending on styles and size, Gruvlok fittings are provided in various materials including ductile iron, forged steel or fabricated steel.

Pressure ratings of Gruvlok standard fittings conform to those of Fig. 7001 Gruvlok coupling.

For Listings/Approval Details and Limitations, visit our website at www.asc-es.com or contact an ASC Engineered Solutions™ Sales Representative.

- Introduction
- Couplings
- Outlets
- Fittings**
- Valves & Accessories
- High Pressure
- CTS Copper System
- DI-Electric Nipples
- Plan-End Fittings
- HDPE Couplings
- Sock-It® Fittings
- Stainless Steel Method
- Roll Groovers
- Installation & Assembly
- Special Coatings
- Design Services
- Technical Data
- Master Format 3 Part Specs.
- Pictorial Index

Elbows

Fig. 7050, 7051, 7052

Flow Data - Frictional Resistance (Expressed as Equivalent Straight Pipe)

Nominal Size	O.D.	Pipe Wall Thickness	Elbow		Tee	
			90°	45°	Branch	Run
In./DN(mm)	In./mm	In./mm	Ft./m	Ft./m	Ft./m	Ft./m
1	1.315	0.133	1.7	0.9	4.4	1.7
25	33.4	3.4	0.5	0.3	1.3	0.5
1 ¼	1.660	0.140	2.3	1.2	5.8	2.3
32	42.2	3.6	0.7	0.4	1.8	0.7
1 ½	1.900	0.145	2.7	1.3	6.7	2.7
40	48.3	3.7	0.8	0.4	2.0	0.8
2	2.375	0.154	3.4	1.7	8.6	3.4
50	60.3	3.9	1.0	0.5	2.6	1.0
2 ½	2.875	0.203	4.1	2.1	10.3	4.1
65	73.0	5.2	1.2	0.6	3.1	1.2
3 O.D.	2.996	0.197	4.3	2.2	10.8	4.3
76.1	76.1	5.0	1.3	0.7	3.3	1.3
3	3.500	0.216	5.1	2.6	12.8	5.1
80	88.9	5.5	1.6	0.8	3.9	1.6
4 ¼ O.D.	4.250	0.220	6.4	3.2	16.1	6.4
108.0	108.0	5.6	2.0	1.0	4.9	2.0
4	4.500	0.237	6.7	3.4	16.8	6.7
100	114.3	6.0	2.0	1.0	5.1	2.0
5 ¼ O.D.	5.236	0.248	8.0	4.0	20.1	8.0
133.0	133.0	6.3	2.4	1.2	6.1	2.4
5 ½ O.D.	5.500	0.248	8.3	4.2	20.9	8.3
139.7	139.7	6.3	2.5	1.3	6.4	2.5
5	5.563	0.258	8.4	4.2	21.0	8.4
125	141.3	6.6	2.6	1.3	6.4	2.6
6 ¼ O.D.	6.259	0.280	9.7	4.9	24.3	9.7
159.0	159.0	7.1	3.0	1.5	7.4	3.0
6 ½ O.D.	6.500	0.280	10.0	5.0	24.9	10.0
165.1	165.1	7.1	3.0	1.5	7.6	3.0
6	6.625	0.280	10.1	5.1	25.3	10.1
150	168.3	7.1	3.1	1.6	7.7	3.1
8	8.625	0.322	13.3	6.7	33.3	13.3
200	219.1	8.2	4.1	2.0	10.1	4.1
10	10.750	0.365	16.7	8.4	41.8	16.7
250	273.1	9.3	5.1	2.6	12.7	5.1
12	12.750	0.375	20.0	10.0	50.0	20.0
300	323.9	9.5	6.1	3.0	15.2	6.1
14	14.000	0.375	22.2	11.1	55.6	22.2
350	355.6	9.5	6.8	3.4	19.6	6.8
16	16.000	0.375	25.5	12.8	64.0	25.5
400	406.4	9.5	7.8	3.9	22.5	7.8
18	18.000	0.375	28.9	14.5	72.0	28.9
450	457.2	9.5	8.8	4.4	26.6	8.8
20	20.000	0.375	32.2	16.1	80.0	32.2
500	508.0	9.5	9.8	4.9	29.7	9.8
24	24.000	0.375	38.9	19.5	97.3	38.9
600	609.6	9.5	11.9	5.9	34.4	11.9

Fitting Size

Nominal Size	O.D.
In./DN(mm)	In./mm
1	1.315
25	33.4
1 ¼	1.660
32	42.4
1 ½	1.900
40	48.3
2	2.375
50	60.3
2 ½	2.875
65	73.0
3 O.D.	2.996
76.1	76.1
3	3.500
80	88.9
3 ½	4.000
90	101.6
4 ¼ O.D.	4.250
108.0	108.0
4	4.500
100	114.3
5 ¼ O.D.	5.236
133.0	133.0
5 ½ O.D.	5.500
139.7	139.7
5	5.563
140	141.3
6 ¼ O.D.	6.259
159.0	159.0
6 ½ O.D.	6.500
165.1	165.1
6	6.625
150	168.3
8	8.625
200	219.1
10	10.750
250	273.0
12	12.750
300	323.9
14	14.000
350	355.6
16	16.000
400	406.4
18	18.000
450	457.2
20	20.000
500	508.0
24	24.000
600	609.6

Note:

For the reducing tee and branches, use the value that is corresponding to the branch size. For example: for 6" x 6" x 3" tee, the branch value of 3" is 12.8 ft (3.9).

The Fitting Size Chart is used to determine the O.D. of the pipe that the fittings is to be used with. Gruvlok Fittings are identified by either the Nominal size in inches or the Pipe O.D. in/mm.

Fig. 7050
90° Elbow*

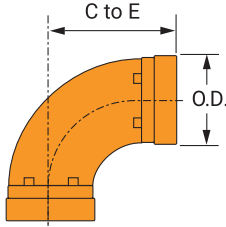

Nominal Size	O.D.	Center to End	Approx. Wt. Ea.
In./DN(mm)	In./mm	In./mm	Lbs./kg
1	1.315	2¼ C	0.6
25	33.4	57	0.3
1¼	1.660	2¾ C	1.0
32	42.2	70	0.5
1½	1.900	2¾ C	1.2
40	48.3	70	0.5
2	2.375	3¼ C	1.7
50	60.3	83	0.8
2½	2.875	3¾ C	2.6
65	73.0	95	1.2
3 O.D.	2.996	4 C	3.6
76.1	76.1	102	1.6
3	3.500	4¼ C	4.0
80	88.9	108	1.8
3½	4.000	4½ C	5.5
90	101.6	114	2.5
4¼ O.D.	4.250	4¾ C	7.7
108.0	108.0	121	3.5
4	4.500	5 C	7.7
100	114.3	127	3.5
5¼ O.D.	2.236	5¼ C	10.4
133.0	133.0	133	4.7
5½ O.D.	5.500	5¼ C	10.9
139.7	139.7	133	4.9

Fig. 7051
45° Elbow*

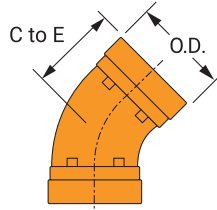

Nominal Size	O.D.	Center to End	Approx. Wt. Ea.
In./DN(mm)	In./mm	In./mm	Lbs./kg
1	1.315	1¾ C	0.5
25	33.4	44	0.2
1¼	1.660	1¾ C	0.7
32	42.2	44	0.3
1½	1.900	1¾ C	0.9
40	48.3	44	0.4
2	2.375	2 C	1.5
50	60.3	51	0.7
2½	2.875	2¼ C	1.9
65	73.0	57	0.9
3 O.D.	2.996	2½ C	2.2
76.1	76.1	64	1.0
3	3.500	2½ C	3.3
80	88.9	64	1.5
3½	4.000	2¾ C	4.3
90	101.6	70	2.0
4¼ O.D.	4.250	2⅞ C	4.4
108.0	108.0	83	2.0
4	4.500	3 C	5.4
100.0	114.3	76	2.4
5¼ O.D.	2.236	3¼ C	7.3
133.0	133.0	83	3.3
5½ O.D.	5.500	3¼ C	7.8
139.7	139.7	83	3.5

Fig. 7052
22½° Elbow

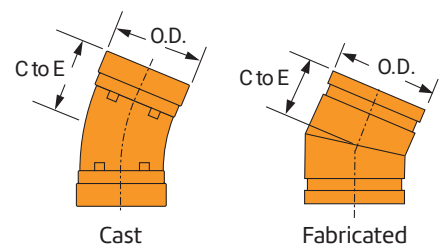

Nominal Size	O.D.	Center to End	Approx. Wt. Ea.
In./DN(mm)	In./mm	In./mm	Lbs./kg
1	1.315	3¼	0.5
25	33.4	83	0.2
1¼	1.660	1¾	0.7
32	42.2	44	0.3
1½	1.900	1¾	0.8
40	48.3	44	0.4
2	2.375	1⅞ C	1.5
50	60.3	48	0.7
2½	2.875	2	1.9
65	73.0	51	0.9
3	3.500	2¼ C	3.2
80	88.9	57	1.5
3½	4.000	2½	4.0
90	101.6	64	1.8
4	4.500	2⅝ C	5.3
100	114.3	67	2.4
5	5.563	2⅞	7.2
125	141.3	73	3.3
6	6.625	3⅞ C	8.2
150	168.3	79	3.7
8	8.625	3⅞ C	17.8
200	219.1	98	8.1
10	10.750	4⅞	30.0
250	273.1	111	13.6

Note:

C - Cast ductile iron, all others are fabricated steel.

*14"-24" Standard Radius 90° & 45° Elbows are 1½ Long Radius.

Center to end dimensions and weights may differ from those shown in chart, contact an ASC Engineered Solutions™ Representative for more information.



For Listings/Approval Details and Limitations, visit our website at www.asc-es.com or contact an ASC Engineered Solutions™ Sales Representative.

Fig. 7050
90° Elbow*

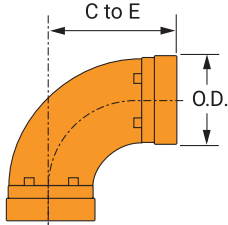

Nominal Size	O.D.	Center to End	Approx. Wt. Ea.
In./DN(mm)	In./mm	In./mm	Lbs./kg
5	5.563	5½ C	11.1
125	141.3	140	5.0
6¼ O.D.	6.259	6 C	15.2
159.0	159.0	152	6.9
6½ O.D.	6.500	6½ C	17.4
165.1	165.1	165	7.9
6	6.625	6½ C	16.5
150	168.3	165	7.5
8	8.625	7¾ C	30.6
200	219.1	197	13.9
10	10.75	9 C	53.5
250	273.1	229	24.3
12	12.750	10 C	82.0
300	323.9	254	37.2
14*	14.000	21 C	176.0
350	355.6	533	79.8
16*	16.000	24 C	230.0
400	406.4	610	104.3
18*	18.000	27 C	293.0
450	457.2	686	132.9
20*	20.000	30 C	362.0
500	508	762	164.2
24*	24.000	36 C	520.0
600	609.6	914	235.9

Fig. 7051
45° Elbow*

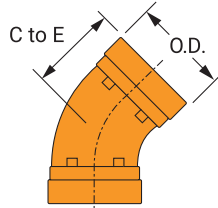

Nominal Size	O.D.	Center to End	Approx. Wt. Ea.
In./DN(mm)	In./mm	In./mm	Lbs./kg
5	5.563	3¼ C	9.0
125.0	141.3	83	4.1
6¼ O.D.	6.259	3½ C	10.1
159.0	159.0	89	4.6
6½ O.D.	6.500	3½ C	11.1
165.1	165.1	89	5.0
6	6.625	3½ C	11.2
150	168.3	89	5.1
8	8.625	4¼ C	19.8
200	219.1	108	9.0
10	10.75	4¾ C	34.3
250	273.1	121	15.6
12	12.75	5¼ C	50.0
300	323.9	133	22.7
14*	14.000	8¾ C	89.0
350	355.6	222	40.4
16*	16.000	10 C	125.0
400	406.4	254	56.7
18*	18.000	11¼ C	158.0
450	457.2	286	71.7
20*	20.000	12½ C	194.0
500	508.0	317	88.0
24*	24.000	15 C	277.0
600	609.6	381	125.6

Fig. 7052
22½° Elbow

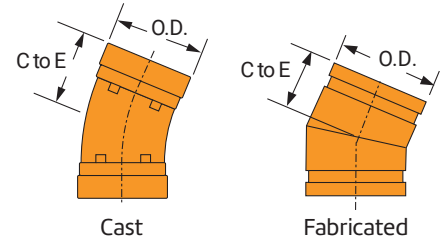

Nominal Size	O.D.	Center to End	Approx. Wt. Ea.
In./DN(mm)	In./mm	In./mm	Lbs./kg
12	12.750	4¾	40.4
300	323.9	124	18.3
14	14.000	5	46.0
350	355.6	127	20.9
16	16.000	5	52.2
400	406.4	127	23.7
18	18.000	5½	65.0
450	457.2	140	29.5
20	20.000	6	80.0
500	508.0	152	36.3
24	24.000	7	112.0
600	609.6	178	50.8

Note:

C – Cast ductile iron, all others are fabricated steel.

*14"–24" Standard Radius 90° & 45° Elbows are 1½ Long Radius.

Center to end dimensions and weights may differ from those shown in chart, contact an ASC Engineered Solutions™ Representative for more information.



- Fig. 7050LR** 90° Long Radius Elbow
- Fig. 7051LR** 45° Long Radius Elbow
- Fig. 7053** 11¼° Elbow

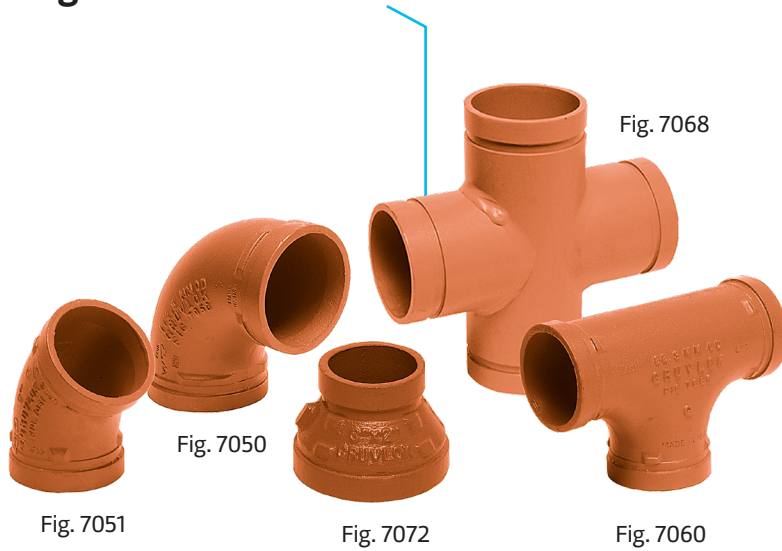

Material Specifications

Cast Fittings

Ductile iron conforming to ASTM A536, Grade 65-45-12
 Malleable iron conforming to ASTM A47

Fabricated Fittings

1-12" Carbon steel, Schedule 40, conforming to ASTM A53, Grade B
 14-24" Carbon steel, 0.375 wall, conforming to ASTM A53, Grade B

Coatings

Rust inhibiting paint
 Color: Orange (standard)
 Hot Dipped Zinc Galvanized conforming to ASTM A153 (optional)
 Other Colors Available (IE: RAL3000 and RAL9000)

Gruvlok fittings are available through 24" nominal pipe size in a variety of styles. Use the Fitting Size Table to convert nominal pipe size to corresponding pipe O.D.

These fittings are designed to provide minimum pressure drop and uniform strength.

Depending on styles and size, Gruvlok fittings are provided in various materials including ductile iron, forged steel or fabricated steel.

Pressure ratings of Gruvlok standard fittings conform to those of Fig. 7001 Gruvlok coupling.

For Listings/Approval Details and Limitations, visit our website at www.asc-es.com or contact an ASC Engineered Solutions™ Sales Representative.

- Introduction
- Couplings
- Outlets
- Fittings**
- Valves & Accessories
- High Pressure
- CTS Copper System
- DI-Electric Nipples
- Plan-End Fittings
- HDPE Couplings
- Socket-It® Fittings
- Stainless Steel Method
- Roll Groovers
- Installation & Assembly
- Special Coatings
- Design Services
- Technical Data
- Master Format 3 Part Specs.
- Pictorial Index

Long Radius Elbows & Elbow Fig. 7050LR, 7051LR, 7053

Flow Data - Frictional Resistance (Expressed as Equivalent Straight Pipe)

Nominal Size	O.D.	Pipe Wall Thickness	Elbow		Tee	
			90°	45°	Branch	Run
In./DN(mm)	In./mm	In./mm	Ft./m	Ft./m	Ft./m	Ft./m
1	1.315	0.133	1.7	0.9	4.4	1.7
25	33.4	3.4	0.5	0.3	1.3	0.5
1¼	1.660	0.140	2.3	1.2	5.8	2.3
32	42.2	3.6	0.7	0.4	1.8	0.7
1½	1.900	0.145	2.7	1.3	6.7	2.7
40	48.3	3.7	0.8	0.4	2.0	0.8
2	2.375	0.154	3.4	1.7	8.6	3.4
50	60.3	3.9	1.0	0.5	2.6	1.0
2½	2.875	0.203	4.1	2.1	10.3	4.1
65	73.0	5.2	1.2	0.6	3.1	1.2
3 O.D.	2.996	0.197	4.3	2.2	10.8	4.3
76.1	76.1	5.0	1.3	0.7	3.3	1.3
3	3.500	0.216	5.1	2.6	12.8	5.1
80	88.9	5.5	1.6	0.8	3.9	1.6
4¼ O.D.	4.250	0.220	6.4	3.2	16.1	6.4
108.0	108.0	5.6	2.0	1.0	4.9	2.0
4	4.500	0.237	6.7	3.4	16.8	6.7
100	114.3	6.0	2.0	1.0	5.1	2.0
5¼ O.D.	5.236	0.248	8.0	4.0	20.1	8.0
133.0	133.0	6.3	2.4	1.2	6.1	2.4
5½ O.D.	5.500	0.248	8.3	4.2	20.9	8.3
139.7	139.7	6.3	2.5	1.3	6.4	2.5
5	5.563	0.258	8.4	4.2	21.0	8.4
125	141.3	6.6	2.6	1.3	6.4	2.6
6¼ O.D.	6.259	0.280	9.7	4.9	24.3	9.7
159.0	159.0	7.1	3.0	1.5	7.4	3.0
6½ O.D.	6.500	0.280	10.0	5.0	24.9	10.0
165.1	165.1	7.1	3.0	1.5	7.6	3.0
6	6.625	0.280	10.1	5.1	25.3	10.1
150	168.3	7.1	3.1	1.6	7.7	3.1
8	8.625	0.322	13.3	6.7	33.3	13.3
200	219.1	8.2	4.1	2.0	10.1	4.1
10	10.750	0.365	16.7	8.4	41.8	16.7
250	273.1	9.3	5.1	2.6	12.7	5.1
12	12.750	0.375	20.0	10.0	50.0	20.0
300	323.9	9.5	6.1	3.0	15.2	6.1
14	14.000	0.375	22.2	17.7	64.2	22.9
350	355.6	9.5	6.8	5.4	19.6	7.0
16	16.000	0.375	25.5	20.4	73.9	26.4
400	406.4	9.5	7.8	6.2	22.5	8.0
18	18.000	0.375	28.9	23.1	87.2	31.1
450	457.2	9.5	8.8	7.0	26.6	9.5
20	20.000	0.375	32.2	25.7	97.3	34.8
500	508.0	9.5	9.8	7.8	29.7	10.6
24	24.000	0.375	38.9	31.1	113.0	40.4
600	609.6	9.5	11.9	9.5	34.4	12.3

Fitting Size

Nominal Size	O.D.
In./DN(mm)	In./mm
1	1.315
25	33.4
1¼	1.660
32	42.4
1½	1.900
40	48.3
2	2.375
50	60.3
2½	2.875
65	73.0
3 O.D.	2.996
76.1	76.1
3	3.500
80	88.9
3½	4.000
90	101.6
4¼ O.D.	4.250
108.0	108.0
4	4.500
100	114.3
5¼ O.D.	5.236
133.0	133.0
5½ O.D.	5.500
139.7	139.7
5	5.563
140	141.3
6¼ O.D.	6.259
159.0	159.0
6½ O.D.	6.500
165.1	165.1
6	6.625
150	168.3
8	8.625
200	219.1
10	10.750
250	273.0
12	12.750
300	323.9
14	14.000
350	355.6
16	16.000
400	406.4
18	18.000
450	457.2
20	20.000
500	508.0
24	24.000
600	609.6

Note:

For the reducing tee and branches, use the value that is corresponding to the branch size. For example: for 6" x 6" x 3" tee, the branch value of 3" is 12.8 ft (3.9).

The Fitting Size Chart is used to determine the O.D. of the pipe that the fittings is to be used with. Gruvlok Fittings are identified by either the Nominal size in inches or the Pipe O.D. in/mm.

Fig. 7053
11¼° Elbow

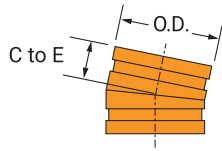

Nominal Size	O.D.	Center to End	Approx. Wt. Ea.
In./DN(mm)	In./mm	In./mm	Lbs./kg
1 25	1.315 33.4	1⅜ 35	0.3 0.1
1¼ 32	1.660 42.2	1⅜ 35	0.5 0.2
1½ 40	1.900 48.3	1⅜ 35	0.7 0.3
2 50	2.375 60.3	1⅜ 35	0.9 0.4
2½ 65	2.875 73.0	1½ 38	1.5 0.7
3 80	3.500 88.9	1½ 38	2.0 0.9
3½ 90	4.000 101.6	1¾ 44	2.8 1.3
4 100	4.500 114.3	1¾ 44	3.3 1.5
5 125	5.563 141.3	2 51	5.0 2.3
6 150	6.625 168.3	2 51	6.5 2.9
8 200	8.625 219.1	2 51	10.0 4.5

Fig. 7050LR
90° Long Radius Elbow

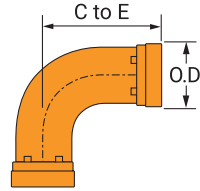

Nominal Size	O.D.	Center to End	Approx. Wt. Ea.
In./DN(mm)	In./mm	In./mm	Lbs./kg
1 25	1.315 33.4	3½ 89	0.9 0.4
1¼ 32	1.660 42.2	3⅞ 98	1.3 0.6
1½ 40	1.900 48.3	4¼ 108	1.7 0.8
2 50	2.375 60.3	4⅞ C 111	2.5 1.1
2½ 65	2.875 73.0	5¾ 146	4.9 2.2
3 80	3.500 88.9	5⅞ C 149	6.5 2.9
3½ 90	4.000 101.6	7¼ 184	9.7 4.4
4 100	4.500 114.3	7½ 191	11.5 5.2
5 125	5.563 141.3	9½ 241	20.9 9.5
6 150	6.625 168.3	10¾ 273	29.1 13.2
8 200	8.625 219.1	15 381	59.2 26.9

Fig. 7051LR
45° Long Radius Elbow

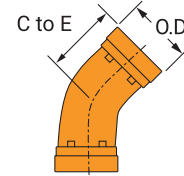

Nominal Size	O.D.	Center to End	Approx. Wt. Ea.
In./DN(mm)	In./mm	In./mm	Lbs./kg
1 25	1.315 33.4	2½ 64	0.7 0.3
1¼ 32	1.660 42.2	2½ 64	1.0 0.5
1½ 40	1.900 48.3	2½ 64	1.2 0.5
2 50	2.375 60.3	2¾ 70	1.7 0.8
2½ 65	2.875 73.0	3 76	2.9 1.3
3 80	3.500 88.9	3⅞ 86	4.3 2.0
3½ 90	4.000 101.6	3½ 89	5.3 2.4
4 100	4.500 114.3	4 102	7.2 3.3
5 125	5.563 141.3	5 127	12.2 5.5
6 150	6.625 168.3	5½ 140	17.4 7.9
8 200	8.625 219.1	7¼ 184	34.0 15.4

Continued on next page.

Note:
C - Cast ductile iron, all others are fabricated steel.
Center to end dimensions and weights may differ from those shown in chart, Contact an ASC Engineered Solutions™ Representative for more information.

For Listings/Approval Details and Limitations, visit our website at www.asc-es.com or contact an ASC Engineered Solutions™ Sales Representative.

Fig. 7053
11¼° Elbow

(Continued)

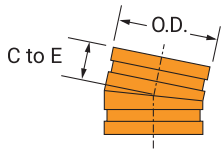

Nominal Size	O.D.	Center to End	Approx. Wt. Ea.
In./DN(mm)	In./mm	In./mm	Lbs./kg
10 250	10.750 273.1	2½ 54	14.5 6.6
12 300	12.750 323.9	2¼ 57	18.7 8.5
14 350	14.000 355.6	3½ 89	32.1 14.6
16 400	16.000 406.4	4 102	42.0 19.1
18 450	18.000 457.2	4½ 114	53.2 24.1
20 500	20.000 508.0	5 127	65.7 29.8
24 600	24.000 609.6	6 152	96.0 43.5

Fig. 7050LR
90° Long Radius Elbow

(Continued)

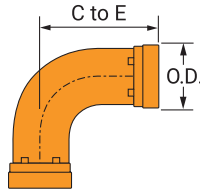

Nominal Size	O.D.	Center to End	Approx. Wt. Ea.
In./DN(mm)	In./mm	In./mm	Lbs./kg
10 250	10.750 273.1	18 457	104.0 47.2
12 300	12.750 323.9	21 533	147.0 66.7
14 350	14.000 355.6	21 C 533	176.0 79.8
16 400	16.000 406.4	24 C 610	230.0 104.3
18 450	18.000 457.2	27 C 686	293.0 132.9
20 500	20.000 508.0	30 C 762	362.0 164.2
24 600	24.000 609.6	36 C 914	520.0 235.9

Fig. 7051LR
45° Long Radius Elbow

(Continued)

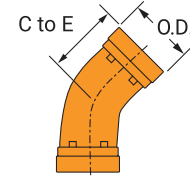

Nominal Size	O.D.	Center to End	Approx. Wt. Ea.
In./DN(mm)	In./mm	In./mm	Lbs./kg
10 250	10.750 273.1	8½ 216	57.4 26.0
12 300	12.750 323.9	10 254	82.6 37.5
14 350	14.000 355.6	8¾ C 222	89.0 40.4
16 400	16.000 406.4	10 C 254	125.0 56.7
18 450	18.000 457.2	11¼ C 286	158.0 71.7
20 500	20.000 508.0	12½ C 317	194.0 88.0
24 600	24.000 609.6	15 C 381	277.0 125.6

Note:

C - Cast ductile iron, all others are fabricated steel.

Center to end dimensions and weights may differ from those shown in chart, Contact an ASC Engineered Solutions™ Representative for more information.



For Listings/Approval Details and Limitations, visit our website at www.asc-es.com or contact an ASC Engineered Solutions™ Sales Representative.

Fig. 7060 Tee
Fig. 7076 Concentric Reducer (GR x THD)

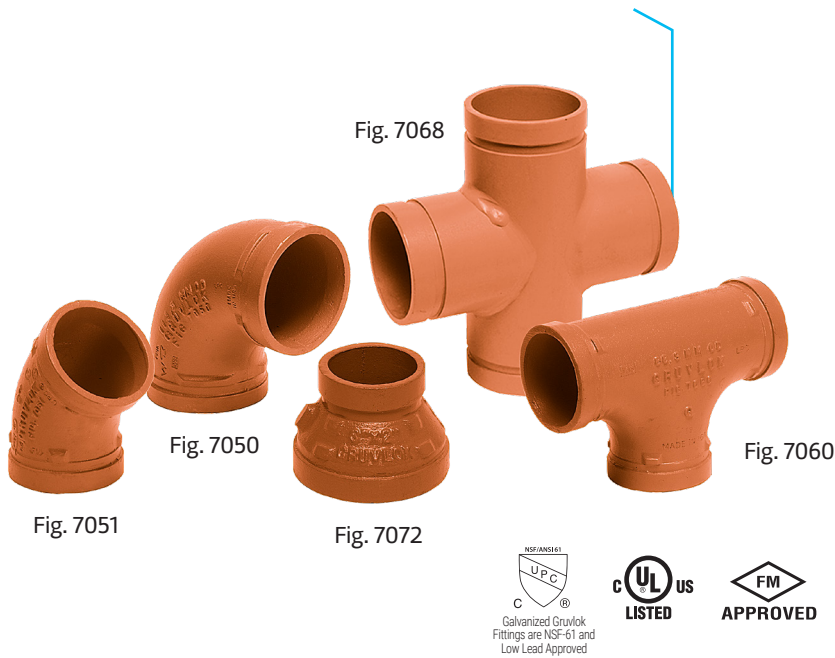

Material Specifications

Cast Fittings

Ductile iron conforming to ASTM A536, Grade 65-45-12

Malleable iron conforming to ASTM A47

Fabricated Fittings

1-12" Carbon steel, Schedule 40, conforming to ASTM A53, Grade B

14-24" Carbon steel, 0.375 wall, conforming to ASTM A53, Grade B

Coatings

Rust inhibiting paint
 Color: Orange (standard)

Hot Dipped Zinc Galvanized conforming to ASTM A153 (optional)

Other Colors Available
 (IE: RAL3000 and RAL9000)

Gruvlok fittings are available through 24" nominal pipe size in a variety of styles. Use the Fitting Size Table to convert nominal pipe size to corresponding pipe O.D.

These fittings are designed to provide minimum pressure drop and uniform strength.

Depending on styles and size, Gruvlok fittings are provided in various materials including ductile iron, forged steel or fabricated steel.

Pressure ratings of Gruvlok standard fittings conform to those of Fig. 7001 Gruvlok coupling.

For Listings/Approval Details and Limitations, visit our website at www.asc-es.com or contact an ASC Engineered Solutions™ Sales Representative.

- Introduction
- Couplings
- Outlets
- Fittings**
- Valves & Accessories
- High Pressure
- CTS Copper System
- DI-Electric Nipples
- Plan-End Fittings
- HDPE Couplings
- Sock-It® Fittings
- Stainless Steel Method
- Roll Groovers
- Installation & Assembly
- Special Coatings
- Design Services
- Technical Data
- Master Format 3 Part Specs.
- Pictorial Index

Tee & Concentric Reducer Fig. 7060, 7076

Flow Data - Frictional Resistance (Expressed as Equivalent Straight Pipe)

Nominal Size	O.D.	Pipe Wall Thickness	Elbow		Tee	
			90°	45°	Branch	Run
In./DN(mm)	In./mm	In./mm	Ft./m	Ft./m	Ft./m	Ft./m
1	1.315	0.133	1.7	0.9	4.4	1.7
25	33.4	3.4	0.5	0.3	1.3	0.5
1¼	1.660	0.140	2.3	1.2	5.8	2.3
32	42.2	3.6	0.7	0.4	1.8	0.7
1½	1.900	0.145	2.7	1.3	6.7	2.7
40	48.3	3.7	0.8	0.4	2.0	0.8
2	2.375	0.154	3.4	1.7	8.6	3.4
50	60.3	3.9	1.0	0.5	2.6	1.0
2½	2.875	0.203	4.1	2.1	10.3	4.1
65	73.0	5.2	1.2	0.6	3.1	1.2
3 O.D.	2.996	0.197	4.3	2.2	10.8	4.3
76.1	76.1	5.0	1.3	0.7	3.3	1.3
3	3.500	0.216	5.1	2.6	12.8	5.1
80	88.9	5.5	1.6	0.8	3.9	1.6
4¼ O.D.	4.250	0.220	6.4	3.2	16.1	6.4
108.0	108.0	5.6	2.0	1.0	4.9	2.0
4	4.500	0.237	6.7	3.4	16.8	6.7
100	114.3	6.0	2.0	1.0	5.1	2.0
5¼ O.D.	5.236	0.248	8.0	4.0	20.1	8.0
133.0	133.0	6.3	2.4	1.2	6.1	2.4
5½ O.D.	5.500	0.248	8.3	4.2	20.9	8.3
139.7	139.7	6.3	2.5	1.3	6.4	2.5
5	5.563	0.258	8.4	4.2	21.0	8.4
125	141.3	6.6	2.6	1.3	6.4	2.6
6¼ O.D.	6.259	0.280	9.7	4.9	24.3	9.7
159.0	159.0	7.1	3.0	1.5	7.4	3.0
6½ O.D.	6.500	0.280	10.0	5.0	24.9	10.0
165.1	165.1	7.1	3.0	1.5	7.6	3.0
6	6.625	0.280	10.1	5.1	25.3	10.1
150	168.3	7.1	3.1	1.6	7.7	3.1
8	8.625	0.322	13.3	6.7	33.3	13.3
200	219.1	8.2	4.1	2.0	10.1	4.1
10	10.750	0.365	16.7	8.4	41.8	16.7
250	273.1	9.3	5.1	2.6	12.7	5.1
12	12.750	0.375	20.0	10.0	50.0	20.0
300	323.9	9.5	6.1	3.0	15.2	6.1
14	14.000	0.375	22.2	11.7	64.2	22.9
350	355.6	9.5	6.8	3.4	19.6	7.0
16	16.000	0.375	25.5	12.4	73.9	26.4
400	406.4	9.5	7.8	3.9	22.5	8.0
18	18.000	0.375	28.9	14.1	87.2	31.1
450	457.2	9.5	8.8	4.4	26.6	9.5
20	20.000	0.375	32.2	15.7	97.3	34.8
500	508.0	9.5	9.8	4.9	29.7	10.6
24	24.000	0.375	38.9	19.1	113.0	40.4
600	609.6	9.5	11.9	5.9	34.4	12.3

Fitting Size

Nominal Size	O.D.
In./DN(mm)	In./mm
1	1.315
25	33.4
1¼	1.660
32	42.4
1½	1.900
40	48.3
2	2.375
50	60.3
2½	2.875
65	73.0
3 O.D.	2.996
76.1	76.1
3	3.500
80	88.9
3½	4.000
90	101.6
4¼ O.D.	4.250
108.0	108.0
4	4.500
100	114.3
5¼ O.D.	5.236
133.0	133.0
5½ O.D.	5.500
139.7	139.7
5	5.563
140	141.3
6¼ O.D.	6.259
159.0	159.0
6½ O.D.	6.500
165.1	165.1
6	6.625
150	168.3
8	8.625
200	219.1
10	10.750
250	273.0
12	12.750
300	323.9
14	14.000
350	355.6
16	16.000
400	406.4
18	18.000
450	457.2
20	20.000
500	508.0
24	24.000
600	609.6

Note:

For the reducing tee and branches, use the value that is corresponding to the branch size. For example: for 6" x 6" x 3" tee, the branch value of 3" is 12.8 ft (3.9).

The Fitting Size Chart is used to determine the O.D. of the pipe that the fittings is to be used with. Gruvlok Fittings are identified by either the Nominal size in inches or the Pipe O.D. in/mm.

Fig. 7060
Tee

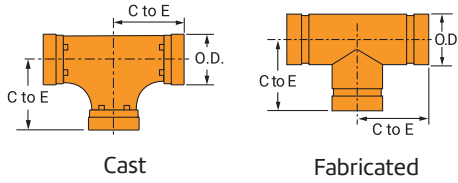
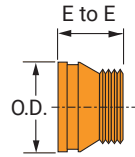

Fig. 7076
Concentric Reducer (GR x THD)



Nominal Size	O.D.	Center to End	Approx. Wt. Ea.
In./DN(mm)	In./mm	In./mm	Lbs./kg
1	1.315	2¼ C	0.9
25.0	33.4	57	0.4
1¼	1.660	2¾ C	1.5
32.0	42.2	70	0.7
1½	1.9	2¾ C	1.8
40.0	48.3	70	0.8
2	2.375	3¼ C	2.4
50.0	60.3	83	1.1
2½	2.875	3¾ C	4.0
65.0	73.0	95	1.8
3 O.D.	2.996	4 C	4.6
76.1	76.1	101	2.1
3	3.500	4¼ C	5.8
80.0	88.9	108	2.6
3½	4.000	4½ C	9.8
90.0	101.6	114	4.4
4¼ O.D.	4.250	4¾ C	9.3
108.0	108.0	121	4.2
4	4.500	5 C	10.3
100.0	114.3	127	4.7
5¼ O.D.	5.236	5¼ C	14.1
133.0	133.0	133	6.4
5½ O.D.	5.500	5½ C	16.1
139.7	139.7	140	7.3
5	5.563	5½ C	16.2
125.0	141.3	140	7.3
6¼ O.D.	6.259	6 C	20.8
159.0	159.0	152	9.4
6½ O.D.	6.500	6½ C	24.4
165.1	165.1	165	11.1
6	6.625	6½ C	25.7
150.0	168.3	165	11.7
8	8.625	7¾ C	41.1
200.0	219.1	197	18.6
10	10.750	9 C	74.5
250.0	273.1	229	33.8
12	12.750	10 C	94.7
300.0	323.9	254	43.0
14	14.000	11 C	181.0
350.0	355.6	279	82.1
16	16.000	12 C	223.0
400.0	406.4	305	101.2
18	18.000	13½ C	334.0
450.0	457.2	343	151.5
20	20.000	15 C	413.0
500.0	508.0	381	187.3
24	24.000	17 C	609.0
600.0	609.6	432	276.2

Nominal Size	End to End	Approx. Wt. Ea.	Nominal Size	End to End	Approx. Wt. Ea.
In./DN(mm)	In./mm	Lbs./kg	In./DN(mm)	In./mm	Lbs./kg
1½ x 1	2½	0.6	3 x 2½	2½	1.5
40 x 25	64	0.3	80 x 65	64	0.7
2 x ¾	2½	1.0	4 x 1	3	2.2
50 x 80	64	0.5	100 x 25	76	1.0
2 x 1	2½	0.8	4 x 1¼	3	2.3
50 x 25	64	0.4	100 x 32	76	1.0
2 x 1¼	2½	1.3	4 x 1½	3	2.3
50 x 32	64	0.6	100 x 40	76	1.0
2 x 1½	2½	1.3	4 x 2	3	2.3
50 x 40	64	0.6	100 x 50	76	1.0
2½ x 1	2½	1.0	4 x 2½	3	2.3
65 x 25	64	0.5	100 x 65	76	1.0
2½ x 1¼	2½	1.0	4 x 3	3	2.6
65 x 32	64	0.5	100 x 80	76	1.2
2½ x 1½	2½	1.3	5 x 4	3½	4.5
65 x 40	64	0.6	125 x 100	89	2.0
2½ x 2	2½	1.2	6 x 1	4	6.0
65 x 50	64	0.5	150 x 25	102	2.7
3 x ¾	2½	1.2	6 x 1¼	4	6.0
80 x 80	64	0.5	150 x 32	102	2.7
3 x 1	2½	1.2	6 x 1½	4	6.0
80 x 25	64	0.5	150 x 40	102	2.7
3 x 1¼	2½	1.3	6 x 2	4	6.0
80 x 32	64	0.6	150 x 50	102	2.7
3 x 1½	2½	1.3	6 x 3	4	6.0
80 x 40	64	0.6	150 x 80	102	2.7
3 x 2	2½	1.3	6 x 4	4	5.9
80 x 50	64	0.6	150 x 100	102	2.7

Note:

All are Fabricated Steel.

See Fitting Size chart on next page for O.D.

C - Cast ductile iron, all others are fabricated steel.



For Listings/Approval Details and Limitations, visit our website at www.asc-es.com or contact an ASC Engineered Solutions™ Sales Representative.

Reducing Tee Standard Fig. 7061

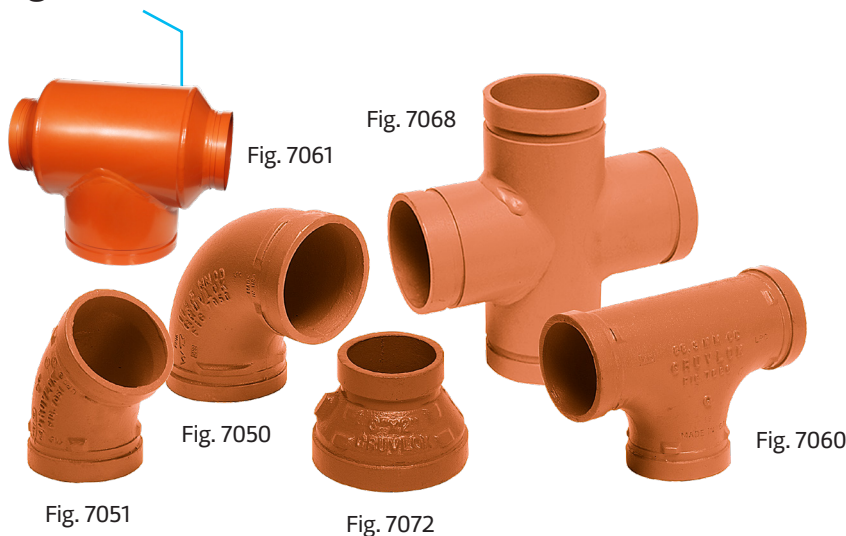

Material Specifications

Cast Fittings

Ductile iron conforming to ASTM A536, Grade 65-45-12

Malleable iron conforming to ASTM A47

Fabricated Fittings

1-12" Carbon steel, Schedule 40, conforming to ASTM A53, Grade B

14-24" Carbon steel, 0.375 wall, conforming to ASTM A53, Grade B

Coatings

Rust inhibiting paint

Color: Orange (standard)

Hot Dipped Zinc Galvanized conforming to ASTM A153 (optional)

Other Colors Available
(IE: RAL3000 and RAL9000)



Gruvlok fittings are available through 24" nominal pipe size in a variety of styles. Use the Fitting Size Table to convert nominal pipe size to corresponding pipe OrD.

These fittings are designed to provide minimum pressure drop and uniform strength.

Depending on styles and size, Gruvlok fittings are provided in various materials including ductile iron, forged steel or fabricated steel.

Pressure ratings of Gruvlok standard fittings conform to those of Fig. 7001 Gruvlok coupling.

For Listings/Approval Details and Limitations, visit our website at www.asc-es.com or contact an ASC Engineered Solutions™ Sales Representative.

Reducing Tee Standard Fig. 7061

Flow Data - Frictional Resistance (Expressed as Equivalent Straight Pipe)

Nominal Size	O.D.	Pipe Wall Thickness	Elbow		Tee	
			90°	45°	Branch	Run
In./DN(mm)	In./mm	In./mm	Ft./m	Ft./m	Ft./m	Ft./m
1	1.315	0.133	1.7	0.9	4.4	1.7
25	33.4	3.4	0.5	0.3	1.3	0.5
1¼	1.660	0.140	2.3	1.2	5.8	2.3
32	42.2	3.6	0.7	0.4	1.8	0.7
1½	1.900	0.145	2.7	1.3	6.7	2.7
40	48.3	3.7	0.8	0.4	2.0	0.8
2	2.375	0.154	3.4	1.7	8.6	3.4
50	60.3	3.9	1.0	0.5	2.6	1.0
2½	2.875	0.203	4.1	2.1	10.3	4.1
65	73.0	5.2	1.2	0.6	3.1	1.2
3 O.D.	2.996	0.197	4.3	2.2	10.8	4.3
76.1	76.1	5.0	1.3	0.7	3.3	1.3
3	3.500	0.216	5.1	2.6	12.8	5.1
80	88.9	5.5	1.6	0.8	3.9	1.6
4¼ O.D.	4.250	0.220	6.4	3.2	16.1	6.4
108.0	108.0	5.6	2.0	1.0	4.9	2.0
4	4.500	0.237	6.7	3.4	16.8	6.7
100	114.3	6.0	2.0	1.0	5.1	2.0
5¼ O.D.	5.236	0.248	8.0	4.0	20.1	8.0
133.0	133.0	6.3	2.4	1.2	6.1	2.4
5½ O.D.	5.500	0.248	8.3	4.2	20.9	8.3
139.7	139.7	6.3	2.5	1.3	6.4	2.5
5	5.563	0.258	8.4	4.2	21.0	8.4
125	141.3	6.6	2.6	1.3	6.4	2.6
6¼ O.D.	6.259	0.280	9.7	4.9	24.3	9.7
159.0	159.0	7.1	3.0	1.5	7.4	3.0
6½ O.D.	6.500	0.280	10.0	5.0	24.9	10.0
165.1	165.1	7.1	3.0	1.5	7.6	3.0
6	6.625	0.280	10.1	5.1	25.3	10.1
150	168.3	7.1	3.1	1.6	7.7	3.1
8	8.625	0.322	13.3	6.7	33.3	13.3
200	219.1	8.2	4.1	2.0	10.1	4.1
10	10.750	0.365	16.7	8.4	41.8	16.7
250	273.1	9.3	5.1	2.6	12.7	5.1
12	12.750	0.375	20.0	10.0	50.0	20.0
300	323.9	9.5	6.1	3.0	15.2	6.1
14	14.000	0.375	22.2	11.1	55.5	22.2
350	355.6	9.5	6.8	3.4	16.6	6.8
16	16.000	0.375	25.5	12.8	63.9	25.5
400	406.4	9.5	7.8	3.9	18.8	7.8
18	18.000	0.375	28.9	14.5	71.2	28.9
450	457.2	9.5	8.8	4.4	20.3	8.8
20	20.000	0.375	32.2	16.1	79.7	32.2
500	508.0	9.5	9.8	4.9	22.1	9.8
24	24.000	0.375	38.9	19.5	95.8	38.9
600	609.6	9.5	11.9	5.9	26.2	11.9

Note:

For the reducing tee and branches, use the value that is corresponding to the branch size. For example: for 6" x 6" x 3" tee, the branch value of 3" is 12.8 ft (3.9).

The Fitting Size Chart is used to determine the O.D. of the pipe that the fittings is to be used with. Gruvlok Fittings are identified by either the Nominal size in inches or the Pipe O.D. in/mm.

Fitting Size

Nominal Size	O.D.
In./DN(mm)	In./mm
1	1.315
25	33.4
1¼	1.660
32	42.4
1½	1.900
40	48.3
2	2.375
50	60.3
2½	2.875
65	73.0
3 O.D.	2.996
76.1	76.1
3	3.500
80	88.9
3½	4.000
90	101.6
4¼ O.D.	4.250
108.0	108.0
4	4.500
100	114.3
5¼ O.D.	5.236
133.0	133.0
5½ O.D.	5.500
139.7	139.7
5	5.563
140	141.3
6¼ O.D.	6.259
159.0	159.0
6½ O.D.	6.500
165.1	165.1
6	6.625
150	168.3
8	8.625
200	219.1
10	10.750
250	273.0
12	12.750
300	323.9
14	14.000
350	355.6
16	16.000
400	406.4
18	18.000
450	457.2
20	20.000
500	508.0
24	24.000
600	609.6

Reducing Tee Standard Fig. 7061

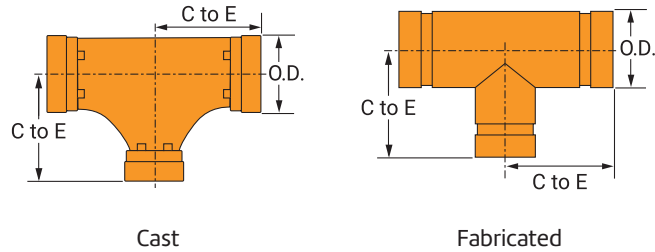

Nominal Size	Center to End	Approx. Wt. Ea.	Nominal Size	Center to End	Approx. Wt. Ea.	Nominal Size	Center to End	Approx. Wt. Ea.
In./DN(mm)	In./mm	Lbs./kg	In./DN(mm)	In./mm	Lbs./kg	In./DN(mm)	In./mm	Lbs./kg
1¼ x 1¼ x 1	2¾	1.5	5 x 5 x 2	5½	14.0	10 x 10 x 8	9	64.7
32 x 32 x 25	70	0.7	125 x 125 x 50	140	6.4	250 x 250 x 200	229	29.3
1½ x 1½ x 1	2¾	1.8	5 x 5 x 2½	5½	14.3	12 x 12 x 4	10	75.1
40 x 40 x 25	70	0.8	125 x 125 x 65	140	6.5	300 x 300 x 100	254	34.1
1½ x 1½ x 1¼	2¾	1.8	5 x 5 x 3	5½	14.6	12 x 12 x 5	10	75.6
40 x 40 x 32	70	0.8	125 x 125 x 80	140	6.6	300 x 300 x 125	254	34.3
2 x 2 x 1	3¼ C	2.6	5 x 5 x 4	5½ C	17.9	12 x 12 x 6	10	76.2
50 x 50 x 25	83	1.2	125 x 125 x 100	140	8.1	300 x 300 x 150	254	34.6
2 x 2 x 1¼	3¼	1.7	6 x 6 x 1	6½	20.5	12 x 12 x 8	10	76.3
50 x 50 x 32	83	0.8	150 x 150 x 25	165	9.3	300 x 300 x 200	254	34.6
2 x 2 x 1½	3¼ C	2.7	6 x 6 x 1¼	6½	20.7	12 x 12 x 10	10	77.6
50 x 50 x 40	83	1.2	150 x 150 x 32	165	9.4	300 x 300 x 250	254	35.2
2½ x 2½ x 1	3¾	4.1	6 x 6 x 1½	6½	21.0	14 x 14 x 6	11	101.0
65 x 65 x 25	95	1.9	150 x 150 x 40	165	9.5	350 x 350 x 150	279	45.8
2½ x 2½ x 1¼	3¾	4.2	6 x 6 x 2	6½ C	26.4	14 x 14 x 8	11	103.0
65 x 65 x 32	95	1.9	150 x 150 x 50	165	12.0	350 x 350 x 200	279	46.7
2½ x 2½ x 1½	3¾	4.3	6 x 6 x 2½	6½ C	26.5	14 x 14 x 10	11	104.0
65 x 65 x 40	95	2.0	150 x 150 x 65	165	12.0	350 x 350 x 250	279	47.2
2½ x 2½ x 2	3¾	4.4	6 x 6 x 3	6½ C	26.5	14 x 14 x 12	11	105.0
65 x 65 x 50	95	2.0	150 x 150 x 80	165	12.0	350 x 350 x 300	279	47.6
3 x 3 x 1	4¼ C	7.0	6 x 6 x 4	6½ C	26.5	16 x 16 x 10	12	129.0
80 x 80 x 25	108	3.2	150 x 150 x 100	165	12.0	400 x 400 x 250	305	58.5
3 x 3 x 1¼	4¼	5.8	6 x 6 x 5	6½ C	28.0	16 x 16 x 12	12	130.0
80 x 80 x 32	108	2.6	150 x 150 x 125	165	12.7	400 x 400 x 300	305	59.0

Note:

C – Cast ductile iron, all others are fabricated steel.

Center to end dimensions and weights may differ from those shown in chart, contact an ASC Engineered Solutions™ Representative for more information.

See Fitting Size chart on previous page for O.D.



For Listings/Approval Details and Limitations, visit our website at www.asc-es.com or contact an ASC Engineered Solutions™ Sales Representative.

Reducing Tee Standard Fig. 7061

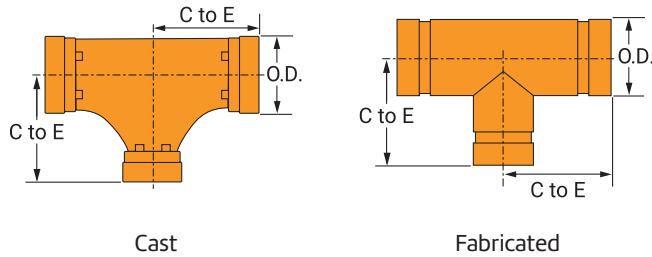

Nominal Size	Center to End	Approx. Wt. Ea.	Nominal Size	Center to End	Approx. Wt. Ea.	Nominal Size	Center to End	Approx. Wt. Ea.
In./DN(mm)	In./mm	Lbs./kg	In./DN(mm)	In./mm	Lbs./kg	In./DN(mm)	In./mm	Lbs./kg
3 x 3 x 1½ 80 x 80 x 40	4¼ 108	5.9 2.7	8 x 8 x 2 200 x 200 x 50	7¾ 197	32.7 14.8	16 x 16 x 14 400 x 400 x 350	12 305	132.0 59.9
3 x 3 x 2 80 x 80 x 50	4¼ C 108	5.5 2.5	8 x 8 x 2½ 200 x 200 x 65	7¾ 197	33.0 15.0	18 x 18 x 10 450 x 450 x 250	15½ 394	194.0 88.0
3 x 3 x 2½ 80 x 80 x 65	4¼ 108	6.3 2.9	8 x 8 x 3 200 x 200 x 80	7¾ 197	33.5 15.2	18 x 18 x 12 450 x 450 x 300	15½ 394	196.0 88.9
4 x 4 x 1 100 x 100 x 25	¾ 95	7.0 3.2	8 x 8 x 4 200 x 200 x 100	¾ C 197	50.0 22.7	18 x 18 x 14 450 x 450 x 350	15½ 394	201.0 91.2
4 x 4 x 1¼ 100 x 100 x 32	5 127	9.6 4.4	8 x 8 x 5 200 x 200 x 125	¾ 197	34.7 15.7	18 x 18 x 16 450 x 450 x 400	15½ 394	203.0 92.1
4 x 4 x 1½ 100 x 100 x 40	5 127	10.2 4.6	8 x 8 x 6 200 x 200 x 150	¾ C 197	54.0 24.5	20 x 20 x 12 500 x 500 x 300	17¼ 438	246.0 111.6
4 x 4 x 2 100 x 100 x 50	5 C 127	10.2 4.6	10 x 10 x 2 250 x 250 x 50	9 229	52.2 23.7	20 x 20 x 14 500 x 500 x 350	17¼ 438	248.0 112.5
4 x 4 x 2½ 100 x 100 x 65	5 C 127	11.2 5.1	10 x 10 x 2½ 250 x 250 x 65	9 229	52.6 23.9	20 x 20 x 16 500 x 500 x 400	17¼ 438	250.0 113.4
4 x 4 x 3 100 x 100 x 80	5 C 127	11.4 5.2	10 x 10 x 3 250 x 250 x 80	9 229	53.0 24.0	20 x 20 x 18 500 x 500 x 450	17¼ 438	252.0 114.3
5 x 5 x 1 125 x 125 x 25	5½ 140	13.6 6.2	10 x 10 x 4 250 x 250 x 100	9 229	53.6 24.3	24 x 24 x 16 600 x 600 x 400	20 508	342.0 155.1
5 x 5 x 1¼ 125 x 125 x 32	5½ 140	13.7 6.2	10 x 10 x 5 250 x 250 x 125	9 229	54.2 24.6	24 x 24 x 18 600 x 600 x 450	20 508	345.0 156.5
5 x 5 x 1½ 125 x 125 x 40	5½ 140	13.8 6.3	10 x 10 x 6 250 x 250 x 150	9 229	55.0 24.9	24 x 24 x 20 600 x 600 x 500	20 508	347.0 157.4

Note:

C - Cast ductile iron, all others are fabricated steel.

Center to end dimensions and weights may differ from those shown in chart, contact an ASC Engineered Solutions™ Representative for more information.

See Fitting Size chart on page 2 for O.D.



For Listings/Approval Details and Limitations, visit our website at www.asc-es.com or contact an ASC Engineered Solutions™ Sales Representative.

Tee with Threaded Branch Fig. 7063

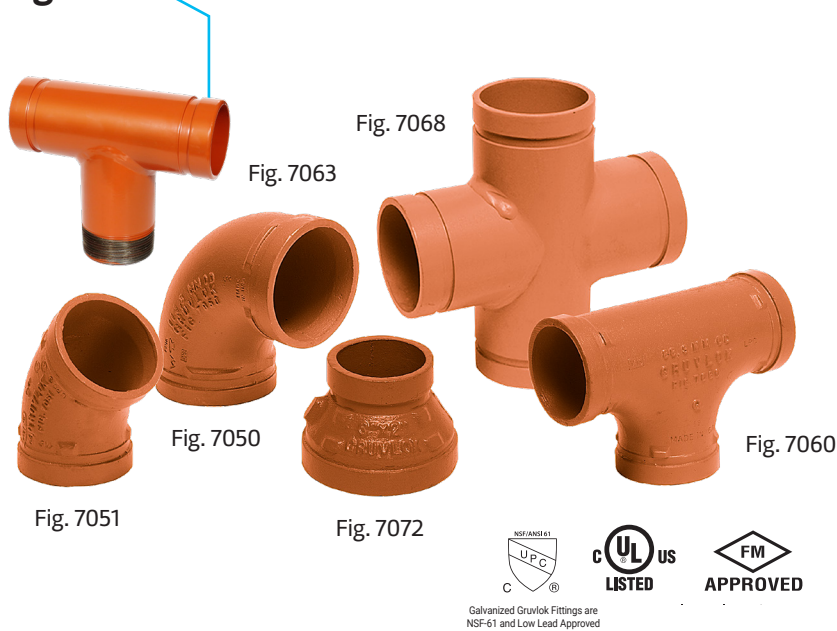

Material Specifications

Cast Fittings

Ductile iron conforming to ASTM A536, Grade 65-45-12

Malleable iron conforming to ASTM A47

Fabricated Fittings

1-12" Carbon steel, Schedule 40, conforming to ASTM A53, Grade B

14-24" Carbon steel, 0.375 wall, conforming to ASTM A53, Grade B

Coatings

Rust inhibiting paint

Color: Orange (standard)

Hot Dipped Zinc Galvanized conforming to ASTM A153 (optional)

Other Colors Available (IE: RAL3000 and RAL9000)

Gruvlok fittings are available through 24" nominal pipe size in a variety of styles. Use the Fitting Size Table to convert nominal pipe size to corresponding pipe O.D.

These fittings are designed to provide minimum pressure drop and uniform strength.

Depending on styles and size, Gruvlok fittings are provided in various materials including ductile iron, forged steel or fabricated steel.

Pressure ratings of Gruvlok standard fittings conform to those of Fig. 7001 Gruvlok coupling.

For Listings/Approval Details and Limitations, visit our website at www.asc-es.com or contact an ASC Engineered Solutions™ Sales Representative.

Tee with Threaded Branch Fig. 7063

Flow Data - Frictional Resistance (Expressed as Equivalent Straight Pipe)

Nominal Size	O.D.	Pipe Wall Thickness	Elbow		Tee	
			90°	45°	Branch	Run
In./DN(mm)	In./mm	In./mm	Ft./m	Ft./m	Ft./m	Ft./m
1	1.315	0.133	1.7	0.9	4.4	1.7
25	33.4	3.4	0.5	0.3	1.3	0.5
1 ¼	1.660	0.140	2.3	1.2	5.8	2.3
32	42.2	3.6	0.7	0.4	1.8	0.7
1 ½	1.900	0.145	2.7	1.3	6.7	2.7
40	48.3	3.7	0.8	0.4	2.0	0.8
2	2.375	0.154	3.4	1.7	8.6	3.4
50	60.3	3.9	1.0	0.5	2.6	1.0
2 ½	2.875	0.203	4.1	2.1	10.3	4.1
65	73.0	5.2	1.2	0.6	3.1	1.2
3 O.D.	2.996	0.197	4.3	2.2	10.8	4.3
76.1	76.1	5.0	1.3	0.7	3.3	1.3
3	3.500	0.216	5.1	2.6	12.8	5.1
80	88.9	5.5	1.6	0.8	3.9	1.6
4 ¼ O.D.	4.250	0.220	6.4	3.2	16.1	6.4
108.0	108.0	5.6	2.0	1.0	4.9	2.0
4	4.500	0.237	6.7	3.4	16.8	6.7
100	114.3	6.0	2.0	1.0	5.1	2.0
5 ¼ O.D.	5.236	0.248	8.0	4.0	20.1	8.0
133.0	133.0	6.3	2.4	1.2	6.1	2.4
5 ½ O.D.	5.500	0.248	8.3	4.2	20.9	8.3
139.7	139.7	6.3	2.5	1.3	6.4	2.5
5	5.563	0.258	8.4	4.2	21.0	8.4
125	141.3	6.6	2.6	1.3	6.4	2.6
6 ¼ O.D.	6.259	0.280	9.7	4.9	24.3	9.7
159.0	159.0	7.1	3.0	1.5	7.4	3.0
6 ½ O.D.	6.500	0.280	10.0	5.0	24.9	10.0
165.1	165.1	7.1	3.0	1.5	7.6	3.0
6	6.625	0.280	10.1	5.1	25.3	10.1
150	168.3	7.1	3.1	1.6	7.7	3.1
8	8.625	0.322	13.3	6.7	33.3	13.3
200	219.1	8.2	4.1	2.0	10.1	4.1
10	10.750	0.365	16.7	8.4	41.8	16.7
250	273.1	9.3	5.1	2.6	12.7	5.1
12	12.750	0.375	20.0	10.0	50.0	20.0
300	323.9	9.5	6.1	3.0	15.2	6.1
14	14.000	0.375	22.2	11.7	64.2	22.9
350	355.6	9.5	6.8	5.4	19.6	7.0
16	16.000	0.375	25.5	12.4	73.9	26.4
400	406.4	9.5	7.8	6.2	22.5	8.0
18	18.000	0.375	28.9	14.1	87.2	31.1
450	457.2	9.5	8.8	7.0	26.6	9.5
20	20.000	0.375	32.2	15.7	97.3	34.8
500	508.0	9.5	9.8	7.8	29.7	10.6
24	24.000	0.375	38.9	19.1	113.0	40.4
600	609.6	9.5	11.9	9.5	34.4	12.3

Note:

For the reducing tee and branches, use the value that is corresponding to the branch size.
For example: for 6" x 6" x 3" tee, the branch value of 3" is 12.8 ft (3.9).

The Fitting Size Chart is used to determine the O.D. of the pipe that the fittings is to be used with.
Gruvlok Fittings are identified by either the Nominal size in inches or the Pipe O.D. in/mm.

Fitting Size

Nominal Size	O.D.
In./DN(mm)	In./mm
1	1.315
25	33.4
1 ¼	1.660
32	42.4
1 ½	1.900
40	48.3
2	2.375
50	60.3
2 ½	2.875
65	73.0
3 O.D.	2.996
76.1	76.1
3	3.500
80	88.9
3 ½	4.000
90	101.6
4 ¼ O.D.	4.250
108.0	108.0
4	4.500
100	114.3
5 ¼ O.D.	5.236
133.0	133.0
5 ½ O.D.	5.500
139.7	139.7
5	5.563
140	141.3
6 ¼ O.D.	6.259
159.0	159.0
6 ½ O.D.	6.500
165.1	165.1
6	6.625
150	168.3
8	8.625
200	219.1
10	10.750
250	273.0
12	12.750
300	323.9
14	14.000
350	355.6
16	16.000
400	406.4
18	18.000
450	457.2
20	20.000
500	508.0
24	24.000
600	609.6

Tee with Threaded Branch Fig. 7063

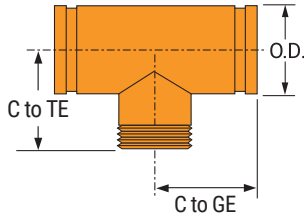

Nominal Size	O.D.	C to GE	C to TE	Approx. Wt. Ea.
In./DN(mm)	In./mm	In./mm	In./mm	Lbs./kg
1 25	1.315 33.4	2¼ 57	2¼ 57	0.9 0.4
1¼ 32	1.660 42.2	2¾ 70	2¾ 70	1.4 0.6
1½ 40	1.9 48.3	2¾ 70	2¾ 70	1.7 0.8
2 50	2.375 60.3	3¼ 83	4¼ 108	2.9 1.3
2½ 65	2.875 73.0	3¾ 95	3¾ 95	4.7 2.1
3 80	3.500 88.9	4¼ 108	6 152	8.1 3.7
4 100	4.5 114.3	5 127	7¼ 184	13.5 6.1
5 125	5.563 140.0	5½ 140	5½ 140	16.7 7.6
6 150	6.625 168.3	6½ 165	6½ 165	25.6 11.6
8 200	8.625 219.1	7¾ 197	7¾ 197	45.0 20.4
10 250	10.750 273.1	9 229	9 229	73.0 33.1
12 300	12.750 323.9	10 254	10 254	98.0 44.5



For Listings/Approval Details and Limitations, visit our website at www.asc-es.com or contact an ASC Engineered Solutions™ Sales Representative.

Reducing Tee with Threaded Branch Fig. 7064

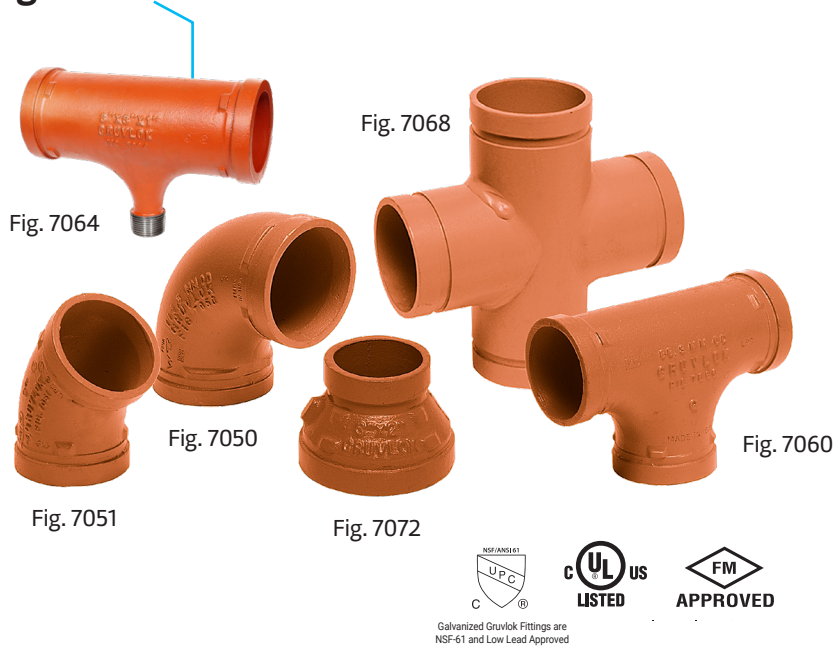

Material Specifications

Cast Fittings

Ductile iron conforming to ASTM A536, Grade 65-45-12
Malleable iron conforming to ASTM A47

Fabricated Fittings

1-12" Carbon steel, Schedule 40, conforming to ASTM A53, Grade B
14-24" Carbon steel, 0.375 wall, conforming to ASTM A53, Grade B

Coatings

Rust inhibiting paint
Color: Orange (standard)
Hot Dipped Zinc Galvanized conforming to ASTM A153 (optional)
Other Colors Available (IE: RAL3000 and RAL9000)

Gruvlok fittings are available through 24" nominal pipe size in a variety of styles. Use the Fitting Size Table to convert nominal pipe size to corresponding pipe O.D.

These fittings are designed to provide minimum pressure drop and uniform strength.

Depending on styles and size, Gruvlok fittings are provided in various materials including ductile iron, forged steel or fabricated steel.

Pressure ratings of Gruvlok standard fittings conform to those of Fig. 7001 Gruvlok coupling.

For Listings/Approval Details and Limitations, visit our website at www.asc-es.com or contact an ASC Engineered Solutions™ Sales Representative.

- Introduction
- Couplings
- Outlets
- Fittings**
- Valves & Accessories
- High Pressure
- CTS Copper System
- DI-Electric Nipples
- Plan-End Fittings
- HDPE Couplings
- Sock-It® Fittings
- Stainless Steel Method
- Roll Groovers
- Installation & Assembly
- Special Coatings
- Design Services
- Technical Data
- Master Format 3 Part Specs.
- Pictorial Index

Reducing Tee with Threaded Branch Fig. 7064

Flow Data - Frictional Resistance (Expressed as Equivalent Straight Pipe)

Nominal Size	O.D.	Pipe Wall Thickness	Elbow		Tee	
			90°	45°	Branch	Run
In./DN(mm)	In./mm	In./mm	Ft./m	Ft./m	Ft./m	Ft./m
1	1.315	0.133	1.7	0.9	4.4	1.7
25	33.4	3.4	0.5	0.3	1.3	0.5
1 ¼	1.660	0.140	2.3	1.2	5.8	2.3
32	42.2	3.6	0.7	0.4	1.8	0.7
1 ½	1.900	0.145	2.7	1.3	6.7	2.7
40	48.3	3.7	0.8	0.4	2.0	0.8
2	2.375	0.154	3.4	1.7	8.6	3.4
50	60.3		1.0	0.5	2.6	1.0
2 ½	2.875	0.203	4.1	2.1	10.3	4.1
65	73.0	5.2	1.2	0.6	3.1	1.2
3 O.D.	2.996	0.197	4.3	2.2	10.8	4.3
76.1	76.1	5.0	1.3	0.7	3.3	1.3
3	3.500	0.216	5.1	2.6	12.8	5.1
80	88.9	5.5	1.6	0.8	3.9	1.6
4 ¼ O.D.	4.250	0.220	6.4	3.2	16.1	6.4
108.0	108.0	5.6	2.0	1.0	4.9	2.0
4	4.500	0.237	6.7	3.4	16.8	6.7
100	114.3	6.0	2.0	1.0	5.1	2.0
5 ¼ O.D.	5.236	0.248	8.0	4.0	20.1	8.0
133.0	133.0	6.3	2.4	1.2	6.1	2.4
5 ½ O.D.	5.500	0.248	8.3	4.2	20.9	8.3
139.7	139.7	6.3	2.5	1.3	6.4	2.5
5	5.563	0.258	8.4	4.2	21.0	8.4
125	141.3	6.6	2.6	1.3	6.4	2.6
6 ¼ O.D.	6.259	0.280	9.7	4.9	24.3	9.7
159.0	159.0	7.1	3.0	1.5	7.4	3.0
6 ½ O.D.	6.500	0.280	10.0	5.0	24.9	10.0
165.1	165.1	7.1	3.0	1.5	7.6	3.0
6	6.625	0.280	10.1	5.1	25.3	10.1
150	168.3	7.1	3.1	1.6	7.7	3.1
8	8.625	0.322	13.3	6.7	33.3	13.3
200	219.1	8.2	4.1	2.0	10.1	4.1
10	10.750	0.365	16.7	8.4	41.8	16.7
250	273.1	9.3	5.1	2.6	12.7	5.1
12	12.750	0.375	20.0	10.0	50.0	20.0
300	323.9	9.5	6.1	3.0	15.2	6.1
14	14.000	0.375	22.2	11.7	64.2	22.9
350	355.6	9.5	6.8	5.4	19.6	7.0
16	16.000	0.375	25.5	12.4	73.9	26.4
400	406.4	9.5	7.8	6.2	22.5	8.0
18	18.000	0.375	28.9	14.1	87.2	31.1
450	457.2	9.5	8.8	7.0	26.6	9.5
20	20.000	0.375	32.2	15.7	97.3	34.8
500	508.0	9.5	9.8	7.8	29.7	10.6
24	24.000	0.375	38.9	19.1	113.0	40.4
600	609.6	9.5	11.9	9.5	34.4	12.3

Fitting Size

Nominal Size	O.D.
In./DN(mm)	In./mm
1	1.315
25	33.4
1 ¼	1.660
32	42.4
1 ½	1.900
40	48.3
2	2.375
50	60.3
2 ½	2.875
65	73.0
3 O.D.	2.996
76.1	76.1
3	3.500
80	88.9
3 ½	4.000
90	101.6
4 ¼ O.D.	4.250
108.0	108.0
4	4.500
100	114.3
5 ¼ O.D.	5.236
133.0	133.0
5 ½ O.D.	5.500
139.7	139.7
5	5.563
140	141.3
6 ¼ O.D.	6.259
159.0	159.0
6 ½ O.D.	6.500
165.1	165.1
6	6.625
150	168.3
8	8.625
200	219.1
10	10.750
250	273.0
12	12.750
300	323.9
14	14.000
350	355.6
16	16.000
400	406.4
18	18.000
450	457.2
20	20.000
500	508.0
24	24.000
600	609.6

Note:

For the reducing tee and branches, use the value that is corresponding to the branch size.
For example: for 6" x 6" x 3" tee, the branch value of 3" is 12.8 ft (3.9).

The Fitting Size Chart is used to determine the O.D. of the pipe that the fittings is to be used with.
Gruvlok Fittings are identified by either the Nominal size in inches or the Pipe O.D. in/mm.

Reducing Tee with Threaded Branch Fig. 7064

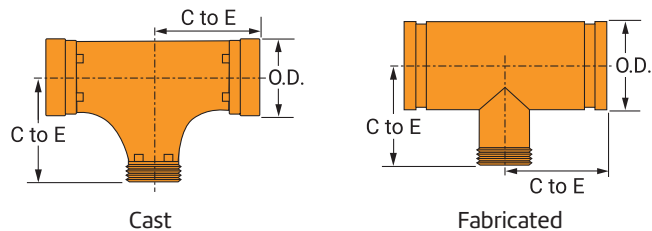

Nominal Size	Center to End	Approx. Wt. Ea.	Nominal Size	Center to End	Approx. Wt. Ea.	Nominal Size	Center to End	Approx. Wt. Ea.
In./DN(mm)	In./mm	Lbs./kg	In./DN(mm)	In./mm	Lbs./kg	In./DN(mm)	In./mm	Lbs./kg
2 x 2 x 3/4 50 x 50 x 20	3 1/4 83	1.6 0.7	5 x 5 x 2 125 x 125 x 50	5 1/2 140	14.5 6.6	12 x 12 x 3 300 x 300 x 80	10 254	84.9 38.5
2 x 2 x 1 50 x 50 x 25	3 1/4 C 83	2.6 1.2	5 x 5 x 2 1/2 125 x 125 x 65	5 1/2 140	17.5 7.9	12 x 12 x 4 300 x 300 x 100	10 254	85.8 38.9
2 x 2 x 1 1/4 50 x 50 x 32	3 1/4 83	1.7 0.8	5 x 5 x 3 125 x 125 x 80	5 1/2 140	16.1 7.3	12 x 12 x 5 300 x 300 x 125	10 254	87.0 39.5
2 x 2 x 1 1/2 50 x 50 x 40	3 1/4 C 83	2.7 1.2	5 x 5 x 4 125 x 125 x 100	5 1/2 140	17.9 8.1	12 x 12 x 6 300 x 300 x 150	10 254	88.3 40.1
2 1/2 x 2 1/2 x 1 65 x 65 x 25	3 3/4 95	4.1 1.9	6 x 6 x 2 150 x 150 x 50	6 1/2 165	26.4 12.0	12 x 12 x 8 300 x 300 x 200	10 254	91.2 41.4
2 1/2 x 2 1/2 x 1 1/4 65 x 65 x 32	3 3/4 95	4.2 1.9	6 x 6 x 2 1/2 150 x 150 x 65	6 1/2 165	26.5 12.0	12 x 12 x 10 300 x 300 x 250	10 254	94.8 43.0
2 1/2 x 2 1/2 x 1 1/2 65 x 65 x 40	3 3/4 95	4.3 2.0	6 x 6 x 3 150 x 150 x 80	6 1/2 165	26.5 12.0	14 x 14 x 8 350 x 350 x 200	11 279	110.0 49.7
2 1/2 x 2 1/2 x 2 65 x 65 x 50	3 3/4 95	4.4 2.0	6 x 6 x 4 150 x 150 x 100	6 1/2 165	26.5 12.0	14 x 14 x 10 350 x 350 x 250	11 279	114.0 51.5
3 x 3 x 3/4 80 x 80 x 20	4 1/4 108	5.7 2.6	6 x 6 x 5 150 x 150 x 125	6 1/2 165	28.0 12.7	14 x 14 x 12 350 x 350 x 300	11 279	117.0 52.8
3 x 3 x 1 80 x 80 x 25	4 1/4 C 108	7.0 3.2	8 x 8 x 2 200 x 200 x 50	7 3/4 197	37.5 17.0	16 x 16 x 8 400 x 400 x 200	12 305	135.0 61.2
3 x 3 x 1 1/4 80 x 80 x 32	4 1/4 108	5.2 2.4	8 x 8 x 2 1/2 200 x 200 x 65	7 3/4 197	38.0 17.2	16 x 16 x 10 400 x 400 x 250	12 305	139.0 63.0
3 x 3 x 1 1/2 80 x 80 x 40	4 1/4 108	5.3 2.4	8 x 8 x 3 200 x 200 x 80	7 3/4 197	38.7 17.6	16 x 16 x 12 400 x 400 x 300	12 305	142.0 64.4
3 x 3 x 2 80 x 80 x 50	4 1/4 108	5.5 2.5	8 x 8 x 4 200 x 200 x 100	7 3/4 197	50.0 22.7			
3 x 3 x 2 1/2 80 x 80 x 65	4 1/4 108	5.8 2.6	8 x 8 x 5 200 x 200 x 125	7 3/4 197	41.0 18.6			

Note:

C - Cast ductile iron, all others are fabricated steel.

Center to end dimensions and weights may differ from those shown in chart, contact an ASC Engineered Sales Representative for more information. See Fitting Size chart on next page for O.D.



For Listings/Approval Details and Limitations, visit our website at www.asc-es.com or contact an ASC Engineered Solutions™ Sales Representative.

Reducing Tee with Threaded Branch Fig. 7064 (Continued)

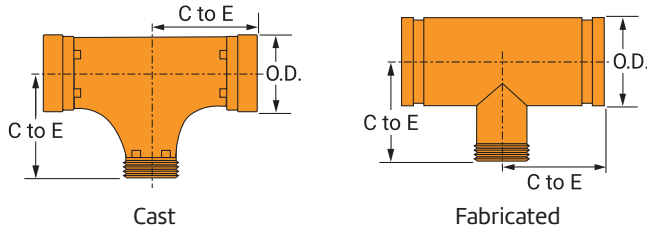

Nominal Size	Center to End	Approx. Wt. Ea.
In./DN(mm)	In./mm	Lbs./kg
4x4x¾ 100 x 100 x 20	¾ 95	7.2 3.3
4x4x1 100 x 100 x 25	¾ 95	7.0 3.2
4x4x1¼ 100 x 100 x 32	5 127	9.1 4.1
4x4x1½ 100 x 100 x 40	5 127	9.2 4.2
4x4x2 100 x 100 x 50	5 127	10.2 4.6
4x4x2½ 100 x 100 x 65	5 127	11.2 5.1
4x4x3 100 x 100 x 80	5 127	11.4 5.2

Nominal Size	Center to End	Approx. Wt. Ea.
In./DN(mm)	In./mm	Lbs./kg
8x8x6 200 x 200 x 150	¾ 197	54.0 24.5
10x10x2 250 x 250 x 50	9 229	61.8 28.0
10x10x3 250 x 250 x 80	9 229	63.0 28.6
10x10x4 250 x 250 x 100	9 229	64.0 29.0
10x10x5 250 x 250 x 125	9 229	65.1 29.5
10x10x6 250 x 250 x 150	9 229	55.0 24.9
10x10x8 250 x 250 x 200	9 229	64.7 29.3

Nominal Size	Center to End	Approx. Wt. Ea.
In./DN(mm)	In./mm	Lbs./kg
18x18x10 450 x 450 x 250	15½ 394	204.0 92.5
18x18x12 450 x 450 x 300	15½ 394	209.0 94.8
18x18x14 450 x 450 x 350	15½ 0	211.0 95.7
18x18x16 450 x 450 x 400	15½ 0	216.0 98.0
24x24x8 600 x 600 x 200	20 508	334.0 152.0
24x24x10 600 x 600 x 250	20 508	342.0 155.0
24x24x12 600 x 600 x 300	20 508	349.0 158.0

Note:

C - Cast ductile iron, all others are fabricated steel.

Center to end dimensions and weights may differ from those shown in chart, contact an ASC Engineered Solutions Sales Representative for more information. See Fitting Size chart on next page for O.D.



For Listings/Approval Details and Limitations, visit our website at www.asc-es.com or contact an ASC Engineered Solutions™ Sales Representative.

Fig. 7073 Eccentric Reducer (GR x GR)
Fig. 7097 Eccentric Reducer (GR x THD)

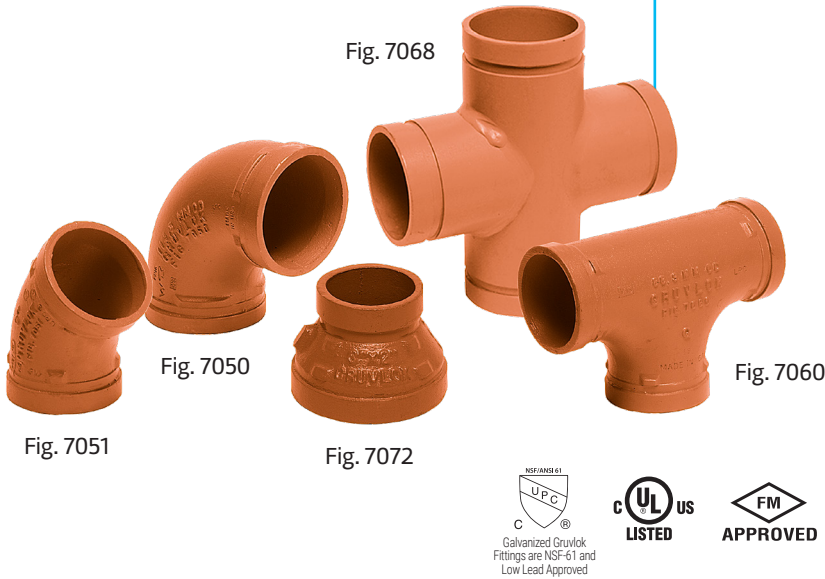

Material Specifications

Cast Fittings

Ductile iron conforming to ASTM A536, Grade 65-45-12

Malleable iron conforming to ASTM A47

Fabricated Fittings

1-12" Carbon steel, Schedule 40, conforming to ASTM A53, Grade B

14-24" Carbon steel, 0.375 wall, conforming to ASTM A53, Grade B

Coatings

Rust inhibiting paint

Color: Orange (standard)

Hot Dipped Zinc Galvanized conforming to ASTM A153 (optional)

Other Colors Available

(IE: RAL3000 and RAL9000)

Gruvlok fittings are available through 24" nominal pipe size in a variety of styles. Use the Fitting Size Table to convert nominal pipe size to corresponding pipe O.D.

These fittings are designed to provide minimum pressure drop and uniform strength.

Depending on styles and size, Gruvlok fittings are provided in various materials including ductile iron, forged steel or fabricated steel.

Pressure ratings of Gruvlok standard fittings conform to those of Fig. 7001 Gruvlok coupling.

For Listings/Approval Details and Limitations, visit our website at www.asc-es.com or contact an ASC Engineered Solutions™ Sales Representative.

- Introduction
- Couplings
- Outlets
- Fittings**
- Valves & Accessories
- High Pressure
- CTS Copper System
- D-I-Electric Nipples
- Plan-End Fittings
- HDPE Couplings
- Socket-It Fittings
- Stainless Steel Method
- Roll Groovers
- Installation & Assembly
- Special Coatings
- Design Services
- Technical Data
- Master Format 3 Part Specs.
- Pictorial Index

Eccentric Reducers Fig. 7073, 7097

Flow Data - Frictional Resistance (Expressed as Equivalent Straight Pipe)

Nominal Size	O.D.	Pipe Wall Thickness	Elbow		Tee	
			90°	45°	Branch	Run
In./DN(mm)	In./mm	In./mm	Ft./m	Ft./m	Ft./m	Ft./m
1	1.315	0.133	1.7	0.9	4.4	1.7
25	33.4	3.4	0.5	0.3	1.3	0.5
1 ¼	1.660	0.140	2.3	1.2	5.8	2.3
32	42.2	3.6	0.7	0.4	1.8	0.7
1 ½	1.900	0.145	2.7	1.3	6.7	2.7
40	48.3	3.7	0.8	0.4	2.0	0.8
2	2.375	0.154	3.4	1.7	8.6	3.4
50	60.3	3.9	1.0	0.5	2.6	1.0
2 ½	2.875	0.203	4.1	2.1	10.3	4.1
65	73.0	5.2	1.2	0.6	3.1	1.2
3 O.D.	2.996	0.197	4.3	2.2	10.8	4.3
76.1	76.1	5.0	1.3	0.7	3.3	1.3
3	3.500	0.216	5.1	2.6	12.8	5.1
80	88.9	5.5	1.6	0.8	3.9	1.6
4 ¼ O.D.	4.250	0.220	6.4	3.2	16.1	6.4
108.0	108.0	5.6	2.0	1.0	4.9	2.0
4	4.500	0.237	6.7	3.4	16.8	6.7
100	114.3	6.0	2.0	1.0	5.1	2.0
5 ¼ O.D.	5.236	0.248	8.0	4.0	20.1	8.0
133.0	133.0	6.3	2.4	1.2	6.1	2.4
5 ½ O.D.	5.500	0.248	8.3	4.2	20.9	8.3
139.7	139.7	6.3	2.5	1.3	6.4	2.5
5	5.563	0.258	8.4	4.2	21.0	8.4
125	141.3	6.6	2.6	1.3	6.4	2.6
6 ¼ O.D.	6.259	0.280	9.7	4.9	24.3	9.7
159.0	159.0	7.1	3.0	1.5	7.4	3.0
6 ½ O.D.	6.500	0.280	10.0	5.0	24.9	10.0
165.1	165.1	7.1	3.0	1.5	7.6	3.0
6	6.625	0.280	10.1	5.1	25.3	10.1
150	168.3	7.1	3.1	1.6	7.7	3.1
8	8.625	0.322	13.3	6.7	33.3	13.3
200	219.1	8.2	4.1	2.0	10.1	4.1
10	10.750	0.365	16.7	8.4	41.8	16.7
250	273.1	9.3	5.1	2.6	12.7	5.1
12	12.750	0.375	20.0	10.0	50.0	20.0
300	323.9	9.5	6.1	3.0	15.2	6.1
14	14.000	0.375	22.2	11.7	64.2	22.9
350	355.6	9.5	6.8	5.4	19.6	7.0
16	16.000	0.375	25.5	12.4	73.9	26.4
400	406.4	9.5	7.8	6.2	22.5	8.0
18	18.000	0.375	28.9	14.1	87.2	31.1
450	457.2	9.5	8.8	7.0	26.6	9.5
20	20.000	0.375	32.2	15.7	97.3	34.8
500	508.0	9.5	9.8	7.8	29.7	10.6
24	24.000	0.375	38.9	19.1	113.0	40.4
600	609.6	9.5	11.9	9.5	34.4	12.3

Fitting Size

Nominal Size	O.D.
In./DN(mm)	In./mm
1	1.315
25	33.4
1 ¼	1.660
32	42.4
1 ½	1.900
40	48.3
2	2.375
50	60.3
2 ½	2.875
65	73.0
3 O.D.	2.996
76.1	76.1
3	3.500
80	88.9
3 ½	4.000
90	101.6
4 ¼ O.D.	4.250
108.0	108.0
4	4.500
100	114.3
5 ¼ O.D.	5.236
133.0	133.0
5 ½ O.D.	5.500
139.7	139.7
5	5.563
140	141.3
6 ¼ O.D.	6.259
159.0	159.0
6 ½ O.D.	6.500
165.1	165.1
6	6.625
150	168.3
8	8.625
200	219.1
10	10.750
250	273.0
12	12.750
300	323.9
14	14.000
350	355.6
16	16.000
400	406.4
18	18.000
450	457.2
20	20.000
500	508.0
24	24.000
600	609.6

Note:

For the reducing tee and branches, use the value that is corresponding to the branch size. For example: for 6" x 6" x 3" tee, the branch value of 3" is 12.8 ft (3.9).

The Fitting Size Chart is used to determine the O.D. of the pipe that the fittings is to be used with. Gruvlok Fittings are identified by either the Nominal size in inches or the Pipe O.D. in/mm.

Fig. 7073
Eccentric Reducer (GR x GR)

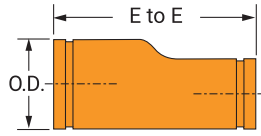

Fabricated

Fig. 7097
Eccentric Reducer (GR x THD)

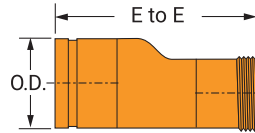

Fabricated

Nominal Size	End to End	Approx. Wt. Ea.	Nominal Size	End to End	Approx. Wt. Ea.	Nominal Size	End to End	Approx. Wt. Ea.	Nominal Size	End to End	Approx. Wt. Ea.
In./DN(mm)	In./mm	Lbs./kg	In./DN(mm)	In./mm	Lbs./kg	In./DN(mm)	In./mm	Lbs./kg	In./DN(mm)	In./mm	Lbs./kg
1 1/4 x 1	8 1/2	1.5	3 1/2 x 3	9 1/2	6.6	8 x 3	12	17.9	16 x 12	14	99.0
32 x 25	216	0.7	90 x 80	241	3.0	200 x 80	305	8.1	400 x 300	356	44.9
1 1/2 x 3/4	8 1/2	1.6	4 x 1	10	5.9	8 x 4	12	19.7	16 x 14	14	104.0
40 x 20	216	0.7	100 x 25	254	2.7	200 x 100	305	8.9	400 x 350	356	47.2
1 1/2 x 1	8 1/2	1.7	4 x 1 1/2	10	6.4	8 x 5	12	21.4	18 x 10	15	110.0
40 x 25	216	0.8	100 x 40	254	2.9	200 x 125	305	9.7	450 x 250	381	49.9
1 1/2 x 1 1/4	8 1/2	4.5	4 x 2	10	6.7	8 x 6	12	23.2	18 x 12	15	113.0
40 x 32	216	2.0	100 x 50	254	3.0	200 x 150	305	10.5	450 x 300	381	51.3
2 x 3/4	9	2.1	4 x 2 1/2	10	7.3	10 x 4	13	29.7	18 x 14	15	117.0
50 x 80	229	1.0	100 x 65	254	3.3	250 x 100	330	13.5	450 x 350	381	53.1
2 x 1	9	2.2	4 x 3	10	7.9	10 x 5	13	31.7	18 x 16	15	121.0
50 x 25	229	1.0	100 x 80	254	3.6	250 x 125	330	14.4	450 x 400	381	54.9
2 x 1 1/4	9	2.4	5 x 2	11	9.3	10 x 6	13	34.0	20 x 10	20	145.0
50 x 32	229	1.1	125 x 50	279	4.2	250 x 150	330	15.4	500 x 250	508	65.8
2 x 1 1/2	9	2.5	5 x 2 1/2	11	9.9	10 x 8	13	34.4	20 x 12	20	149.0
50 x 40	229	1.1	125 x 65	279	4.5	250 x 200	330	15.6	20 x 14	20	152.0
2 1/2 x 1	9 1/2	3.2	5 x 3	11	10.7	12 x 6	14	45.2	500 x 300	508	67.6
65 x 25	241	1.5	125 x 80	279	4.9	300 x 150	356	20.5	20 x 16	20	156.0
2 1/2 x 1 1/4	9 1/2	3.4	5 x 4	11	11.9	12 x 8	14	47.7	500 x 350	508	68.9
65 x 32	241	1.5	125 x 100	279	5.4	300 x 200	356	21.6	20 x 18	20	160.0
2 1/2 x 1 1/2	9 1/2	3.6	6 x 1	11 1/2	12.0	12 x 10	14	52.0	500 x 400	508	70.8
65 x 40	241	1.6	150 x 25	292	5.4	300 x 250	356	23.6	20 x 20	20	179.0
2 1/2 x 2	9 1/2	4.0	6 x 1 1/2	11 1/2	12.1	14 x 6	13	78.0	500 x 450	508	72.6
65 x 50	241	1.8	150 x 40	292	5.5	350 x 150	330	35.4	24 x 12	20	179.0
3 x 1	9 1/2	4.0	6 x 2	11 1/2	12.2	14 x 8	13	80.0	600 x 300	508	81.2
80 x 25	241	1.8	150 x 50	292	5.5	350 x 200	330	36.3	24 x 14	20	184.0
3 x 1 1/4	9 1/2	4.3	6 x 2 1/2	11 1/2	12.8	14 x 10	13	84.0	600 x 350	508	83.5
80 x 32	241	2.0	150 x 65	292	5.8	350 x 250	330	38.1	24 x 16	20	189.0
3 x 1 1/2	9 1/2	4.5	6 x 3	11 1/2	13.6	14 x 12	13	88.0	600 x 400	508	85.7
80 x 40	241	2.0	150 x 80	292	6.2	350 x 300	330	39.9	24 x 18	20	194.0
3 x 2	9 1/2	4.8	6 x 4	11 1/2	14.9	16 x 8	14	91.0	600 x 450	508	88.0
80 x 50	241	2.2	150 x 100	292	6.8	400 x 200	356	41.3	24 x 20	20	199.0
3 x 2 1/2	9 1/2	5.6	6 x 5	11 1/2	16.2	16 x 10	14	96.0	600 x 500	508	90.3
80 x 65	241	2.5	150 x 125	292	7.3	400 x 250	356	43.5			

Note:

Fabricated Steel *Figure 7097 is available in sizes 1 1/4 x 1 through 12 x 10.

Center to end dimensions may differ from those shown above. Contact an ASC Engineered Solutions™ Representative for more information.

See Fitting Size chart on previous page for O.D.



- Fig. 7077** Swaged Nipples (GR x GR)
- Fig. 7078** Swaged Nipples (GR x THD)
- Fig. 7079** Swaged Nipples (GR x BEV)

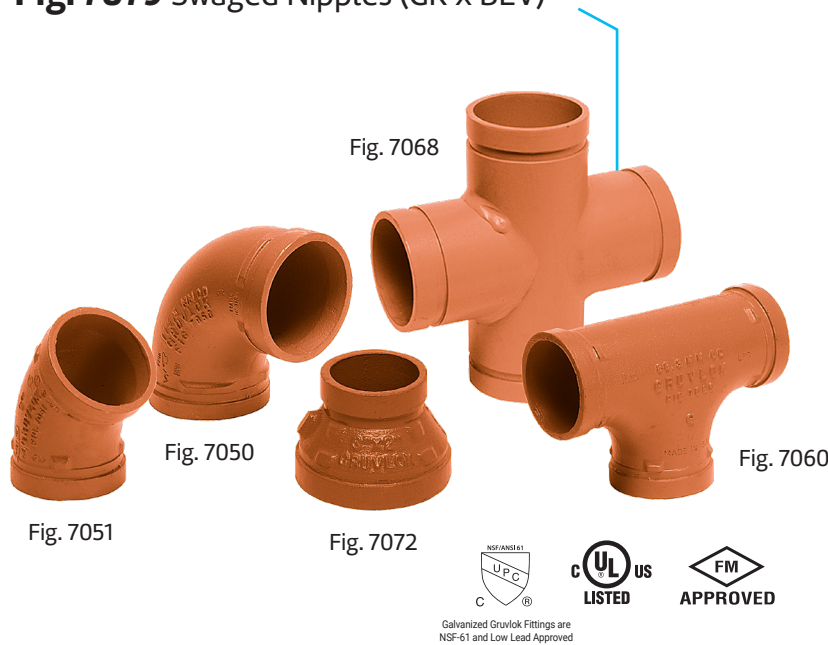

Material Specifications

Cast Fittings

Ductile iron conforming to ASTM A536, Grade 65-45-12

Malleable iron conforming to ASTM A47

Fabricated Fittings

1-12" Carbon steel, Schedule 40, conforming to ASTM A53, Grade B

14-24" Carbon steel, 0.375 wall, conforming to ASTM A53, Grade B

Coatings

Rust inhibiting paint

Color: Orange (standard)

Hot Dipped Zinc Galvanized conforming to ASTM A153 (optional)

Other Colors Available
(IE: RAL3000 and RAL9000)

Gruvlok fittings are available through 24" nominal pipe size in a variety of styles. Use the Fitting Size Table to convert nominal pipe size to corresponding pipe O.D.

These fittings are designed to provide minimum pressure drop and uniform strength.

Depending on styles and size, Gruvlok fittings are provided in various materials including ductile iron, forged steel or fabricated steel.

Pressure ratings of Gruvlok standard fittings conform to those of Fig. 7001 Gruvlok coupling.

For Listings/Approval Details and Limitations, visit our website at www.asc-es.com or contact an ASC Engineered Solutions™ Sales Representative.

Swaged Nipples Fig. 7077, 7078, 7079

Flow Data - Frictional Resistance (Expressed as Equivalent Straight Pipe)

Nominal Size	O.D.	Pipe Wall Thickness	Elbow		Tee	
			90°	45°	Branch	Run
In./DN(mm)	In./mm	In./mm	Ft./m	Ft./m	Ft./m	Ft./m
1	1.315	0.133	1.7	0.9	4.4	1.7
25	33.4	3.4	0.5	0.3	1.3	0.5
1¼	1.660	0.140	2.3	1.2	5.8	2.3
32	42.2	3.6	0.7	0.4	1.8	0.7
1½	1.900	0.145	2.7	1.3	6.7	2.7
40	48.3	3.7	0.8	0.4	2.0	0.8
2	2.375	0.154	3.4	1.7	8.6	3.4
50	60.3	3.9	1.0	0.5	2.6	1.0
2½	2.875	0.203	4.1	2.1	10.3	4.1
65	73.0	5.2	1.2	0.6	3.1	1.2
3 O.D.	2.996	0.197	4.3	2.2	10.8	4.3
76.1	76.1	5.0	1.3	0.7	3.3	1.3
3	3.500	0.216	5.1	2.6	12.8	5.1
80	88.9	5.5	1.6	0.8	3.9	1.6
4¼ O.D.	4.250	0.220	6.4	3.2	16.1	6.4
108.0	108.0	5.6	2.0	1.0	4.9	2.0
4	4.500	0.237	6.7	3.4	16.8	6.7
100	114.3	6.0	2.0	1.0	5.1	2.0
5¼ O.D.	5.236	0.248	8.0	4.0	20.1	8.0
133.0	133.0	6.3	2.4	1.2	6.1	2.4
5½ O.D.	5.500	0.248	8.3	4.2	20.9	8.3
139.7	139.7	6.3	2.5	1.3	6.4	2.5
5	5.563	0.258	8.4	4.2	21.0	8.4
125	141.3	6.6	2.6	1.3	6.4	2.6
6¼ O.D.	6.259	0.280	9.7	4.9	24.3	9.7
159.0	159.0	7.1	3.0	1.5	7.4	3.0
6½ O.D.	6.500	0.280	10.0	5.0	24.9	10.0
165.1	165.1	7.1	3.0	1.5	7.6	3.0
6	6.625	0.280	10.1	5.1	25.3	10.1
150	168.3	7.1	3.1	1.6	7.7	3.1
8	8.625	0.322	13.3	6.7	33.3	13.3
200	219.1	8.2	4.1	2.0	10.1	4.1
10	10.750	0.365	16.7	8.4	41.8	16.7
250	273.1	9.3	5.1	2.6	12.7	5.1
12	12.750	0.375	20.0	10.0	50.0	20.0
300	323.9	9.5	6.1	3.0	15.2	6.1
14	14.000	0.375	22.2	11.1	55.6	22.2
350	355.6	9.5	6.8	3.4	16.6	6.8
16	16.000	0.375	25.5	12.8	63.9	25.5
400	406.4	9.5	7.8	3.9	18.3	7.8
18	18.000	0.375	28.9	14.5	71.2	28.9
450	457.2	9.5	8.8	4.4	20.3	8.8
20	20.000	0.375	32.2	16.1	79.7	32.2
500	508.0	9.5	9.8	4.9	22.8	9.8
24	24.000	0.375	38.9	19.5	95.6	38.9
600	609.6	9.5	11.9	5.9	26.6	11.9

Note:

For the reducing tee and branches, use the value that is corresponding to the branch size. For example: for 6" x 6" x 3" tee, the branch value of 3" is 12.8 ft (3.9).

The Fitting Size Chart is used to determine the O.D. of the pipe that the fittings is to be used with. Gruvlok Fittings are identified by either the Nominal size in inches or the Pipe O.D. in/mm.

Fitting Size

Nominal Size	O.D.
In./DN(mm)	In./mm
1	1.315
25	33.4
1¼	1.660
32	42.4
1½	1.900
40	48.3
2	2.375
50	60.3
2½	2.875
65	73.0
3 O.D.	2.996
76.1	76.1
3	3.500
80	88.9
3¼	4.000
90	101.6
4¼ O.D.	4.250
108.0	108.0
4	4.500
100	114.3
5¼ O.D.	5.236
133.0	133.0
5½ O.D.	5.500
139.7	139.7
5	5.563
140	141.3
6¼ O.D.	6.259
159.0	159.0
6½ O.D.	6.500
165.1	165.1
6	6.625
150	168.3
8	8.625
200	219.1
10	10.750
250	273.0
12	12.750
300	323.9
14	14.000
350	355.6
16	16.000
400	406.4
18	18.000
450	457.2
20	20.000
500	508.0
24	24.000
600	609.6

Fig. 7077
Swaged Nipple (GR x GR)

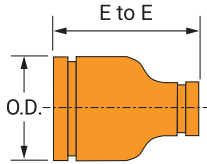

Fig. 7078
Swaged Nipple (GR x THD)

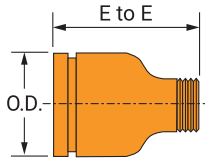
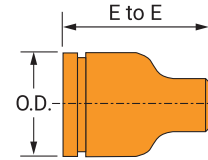

Fig. 7079
Swaged Nipple (GR x BEV)



Nominal Size	End to End	Approx. Wt. Ea.
In./DN(mm)	In./mm	Lbs./kg
2 x 1 50 x 25	6½ C 165	2.0 0.9
2 x 1¼ 50 x 32	6½ 165	2.0 0.9
2 x 1½ 50 x 40	6½ 165	2.0 0.9
2½ x 1 65 x 25	7 178	3.5 1.6
2½ x 1¼ 65 x 32	7 178	3.5 1.6
2½ x 1½ 65 x 40	7 178	3.5 1.6
2½ x 2 65 x 50	7 178	3.5 1.6
3 x 1 80 x 25	8 203	5.0 2.3
3 x 1¼ 80 x 32	8 203	5.0 2.3
3 x 1½ 80 x 40	8 203	5.0 2.3
3 x 2 80 x 50	8 203	5.0 2.3
3 x 2½ 80 x 65	8 203	5.0 2.3
3½ x 3 90 x 80	8 203	7.0 3.2
4 x 1 100 x 25	9 229	8.0 3.6
4 x 1¼ 100 x 32	9 229	8.0 3.6
4 x 1½ 100 x 40	9 229	8.0 3.6
4 x 2 100 x 50	9 229	8.0 3.6

Nominal Size	End to End	Approx. Wt. Ea.
In./DN(mm)	In./mm	Lbs./kg
4 x 2½ 100 x 65	9 229	8.0 3.6
4 x 3 100 x 80	9 229	8.0 3.6
4 x 3½ 100 x 90	9 229	8.0 3.6
5 x 2 125 x 50	11 279	12.0 5.4
5 x 2½ 125 x 65	11 279	12.0 5.4
5 x 3 125 x 80	11 279	12.0 5.4
5 x 4 125 x 100	11 279	12.0 5.4
6 x 1 150 x 25	12 305	19.0 8.6
6 x 1¼ 150 x 32	12 305	19.0 8.6
6 x 1½ 150 x 40	12 305	19.0 8.6
6 x 2 150 x 50	12 305	19.0 8.6
6 x 2½ 150 x 65	12 305	19.0 8.6
6 x 3 150 x 80	12 305	19.0 8.6
6 x 3½ 150 x 90	12 305	17.0 7.7
6 x 4 150 x 100	12 305	19.0 8.6
6 x 5 150 x 125	12 305	19.0 8.6

Note:

This product is not ULC Listed.

See Fitting Size chart on previous page for O.D.



For Listings/Approval Details and Limitations, visit our website at www.asc-es.com or contact an ASC Engineered Solutions™ Sales Representative.

Concentric Reducer (GR x GR) Fig. 7072



Material Specifications

Cast Fittings

Ductile iron conforming to ASTM A536, Grade 65-45-12

Malleable iron conforming to ASTM A47

Fabricated Fittings

1-12" Carbon steel, Schedule 40, conforming to ASTM A53, Grade B

14-24" Carbon steel, 0.375 wall, conforming to ASTM A53, Grade B

Coatings

Rust inhibiting paint

Color: Orange (standard)

Hot Dipped Zinc Galvanized conforming to ASTM A153 (optional)

Other Colors Available (IE: RAL3000 and RAL9000)

Gruvlok fittings are available through 24" nominal pipe size in a variety of styles. Use the Fitting Size Table to convert nominal pipe size to corresponding pipe O.D.

These fittings are designed to provide minimum pressure drop and uniform strength.

Depending on styles and size, Gruvlok fittings are provided in various materials including ductile iron, forged steel or fabricated steel.

Pressure ratings of Gruvlok standard fittings conform to those of Fig. 7001 Gruvlok coupling.

For Listings/Approval Details and Limitations, visit our website at www.asc-es.com or contact an ASC Engineered Solutions™ Sales Representative.

- Introduction
- Couplings
- Outlets
- Fittings**
- Valves & Accessories
- High Pressure
- CTS Copper System
- DI-Electric Nipples
- Plan-End Fittings
- HDPE Couplings
- Socket-Fittings
- Stainless Steel Method
- Roll Groovers
- Installation & Assembly
- Special Coatings
- Design Services
- Technical Data
- Master Format 3 Part Specs.
- Pictorial Index

Concentric Reducer (GR x GR) Fig. 7072

Flow Data - Frictional Resistance (Expressed as Equivalent Straight Pipe)

Nominal Size	O.D.	Pipe Wall Thickness	Elbow		Tee	
			90°	45°	Branch	Run
			In./DN(mm)	In./mm	In./mm	Ft./m
1	1.315	0.133	1.7	0.9	4.4	1.7
25	33.4	3.4	0.5	0.3	1.3	0.5
1 ¼	1.660	0.140	2.3	1.2	5.8	2.3
32	42.2	3.6	0.7	0.4	1.8	0.7
1 ½	1.900	0.145	2.7	1.3	6.7	2.7
40	48.3	3.7	0.8	0.4	2.0	0.8
2	2.375	0.154	3.4	1.7	8.6	3.4
50	60.3	3.9	1.0	0.5	2.6	1.0
2 ½	2.875	0.203	4.1	2.1	10.3	4.1
65	73.0	5.2	1.2	0.6	3.1	1.2
3 O.D.	2.996	0.197	4.3	2.2	10.8	4.3
76.1	76.1	5.0	1.3	0.7	3.3	1.3
3	3.500	0.216	5.1	2.6	12.8	5.1
80	88.9	5.5	1.6	0.8	3.9	1.6
4 ¼ O.D.	4.250	0.220	6.4	3.2	16.1	6.4
108.0	108.0	5.6	2.0	1.0	4.9	2.0
4	4.500	0.237	6.7	3.4	16.8	6.7
100	114.3	6.0	2.0	1.0	5.1	2.0
5 ¼ O.D.	5.236	0.248	8.0	4.0	20.1	8.0
133.0	133.0	6.3	2.4	1.2	6.1	2.4
5 ½ O.D.	5.500	0.248	8.3	4.2	20.9	8.3
139.7	139.7	6.3	2.5	1.3	6.4	2.5
5	5.563	0.258	8.4	4.2	21.0	8.4
125	141.3	6.6	2.6	1.3	6.4	2.6
6 ¼ O.D.	6.259	0.280	9.7	4.9	24.3	9.7
159.0	159.0	7.1	3.0	1.5	7.4	3.0
6 ½ O.D.	6.500	0.280	10.0	5.0	24.9	10.0
165.1	165.1	7.1	3.0	1.5	7.6	3.0
6	6.625	0.280	10.1	5.1	25.3	10.1
150	168.3	7.1	3.1	1.6	7.7	3.1
8	8.625	0.322	13.3	6.7	33.3	13.3
200	219.1	8.2	4.1	2.0	10.1	4.1
10	10.750	0.365	16.7	8.4	41.8	16.7
250	273.1	9.3	5.1	2.6	12.7	5.1
12	12.750	0.375	20.0	10.0	50.0	20.0
300	323.9	9.5	6.1	3.0	15.2	6.1
14	14.000	0.375	22.2	17.7	64.2	22.9
350	355.6	9.5	6.8	5.4	19.6	7.0
16	16.000	0.375	25.5	20.4	73.9	26.4
400	406.4	9.5	7.8	6.2	22.5	8.0
18	18.000	0.375	28.9	23.1	87.2	31.1
450	457.2	9.5	8.8	7.0	26.6	9.5
20	20.000	0.375	32.2	25.7	97.3	34.8
500	508.0	9.5	9.8	7.8	29.7	10.6
24	24.000	0.375	38.9	31.1	113.0	40.4
600	609.6	9.5	11.9	9.5	34.4	12.3

Fitting Size

Nominal Size	O.D.
In./DN(mm)	In./mm
1	1.315
25	33.4
1 ¼	1.660
32	42.4
1 ½	1.900
40	48.3
2	2.375
50	60.3
2 ½	2.875
65	73.0
3 O.D.	2.996
76.1	76.1
3	3.500
80	88.9
3 ½	4.000
90	101.6
4 ¼ O.D.	4.250
108.0	108.0
4	4.500
100	114.3
5 ¼ O.D.	5.236
133.0	133.0
5 ½ O.D.	5.500
139.7	139.7
5	5.563
140	141.3
6 ¼ O.D.	6.259
159.0	159.0
6 ½ O.D.	6.500
165.1	165.1
6	6.625
150	168.3
8	8.625
200	219.1
10	10.750
250	273.0
12	12.750
300	323.9
14	14.000
350	355.6
16	16.000
400	406.4
18	18.000
450	457.2
20	20.000
500	508.0
24	24.000
600	609.6

Note:

For the reducing tee and branches, use the value that is corresponding to the branch size. For example: for 6" x 6" x 3" tee, the branch value of 3" is 12.8 ft (3.9).

The Fitting Size Chart is used to determine the O.D. of the pipe that the fittings is to be used with. Gruvlok Fittings are identified by either the Nominal size in inches or the Pipe O.D. in/mm.

Concentric Reducer (GR x GR) Fig. 7072

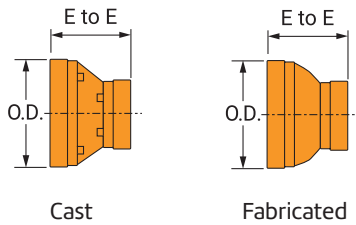

Nominal Size	End to End	Approx. Wt. Ea.	Nominal Size	End to End	Approx. Wt. Ea.	Nominal Size	End to End	Approx. Wt. Ea.	Nominal Size	End to End	Approx. Wt. Ea.
In./DN(mm)	In./mm	Lbs./kg	In./DN(mm)	In./mm	Lbs./kg	In./DN(mm)	In./mm	Lbs./kg	In./DN(mm)	In./mm	Lbs./kg
1 ¼ x 1	2 ½	0.6	4 x 1 ¼	3	2.3	8 x 5	5	11.5	18 x 10	15	82.3
32 x 25	64	0.3	100 x 40	76	1.0	200 x 125	127	5.2	450 x 250	381	37.3
1 ½ x 1	2 ½	0.6	4 x 2	3 C	2.4	8 x 6	5 C	10.6	18 x 12	15	83.6
40 x 25	64	0.3	100 x 50	76	1.1	200 x 150	127	4.8	450 x 300	381	37.9
1 ½ x 1 ¼	2 ½	0.6	4 x 2 ½	3 C	2.6	10 x 4	6	20.0	18 x 14	15	86.2
40 x 32	64	0.3	100 x 65	76	1.2	250 x 100	152	9.1	450 x 350	381	39.1
2 x 1	2 ½	0.8	4 x 3	3 C	3.2	10 x 5	6	20.0	18 x 16	15	87.2
50 x 25	64	0.4	100 x 80	76	1.5	250 x 125	152	9.1	450 x 400	381	39.6
2 x 1 ¼	2 ½ C	1.3	4 x 3 ½	3	3.6	10 x 6	6 C	20.0	20 x 10	20	123.0
50 x 32	64	0.6	100 x 90	76	1.6	250 x 150	152	9.1	500 x 250	508	55.8
2 x 1 ½	2 ½ C	1.3	5 x 2	3 ½	4.6	10 x 8	6 C	23.9	20 x 12	20	125.0
50 x 40	64	0.6	125 x 50	89	2.1	250 x 200	152	10.8	500 x 300	508	56.7
2 ½ x 1	2 ½	1.0	5 x 2 ½	3 ½	4.5	12 x 4	7	25.0	20 x 14	20	129.0
65 x 25	64	0.5	125 x 65	89	2.0	300 x 100	178	11.3	500 x 350	508	58.5
2 ½ x 1 ¼	2 ½	1.0	5 x 3	3 ½	4.4	12 x 6	7	29.0	20 x 16	20	131.0
65 x 32	64	0.5	125 x 80	89	2.0	300 x 150	178	13.2	500 x 400	508	59.4
2 ½ x 1 ½	2 ½	1.3	5 x 4	3 ½ C	4.5	12 x 8	7	29.0	20 x 18	20	133.0
65 x 40	64	0.6	125 x 100	89	2.0	300 x 200	178	13.2	500 x 450	508	60.3
2 ½ x 2	2 ½ C	1.6	6 x 1	4	6.8	12 x 10	7	32.4	24 x 10	20	147.0
65 x 50	64	0.7	150 x 25	102	3.1	300 x 250	178	14.7	600 x 250	508	66.7
3 x 1	2 ½	1.2	6 x 1 ½	4	6.9	14 x 6	13	54.3	24 x 12	20	149.0
80 x 25	64	0.5	150 x 40	102	3.1	350 x 150	330	24.6	600 x 300	508	67.6
3 x 1 ¼	2 ½	1.3	6 x 2	4 C	6.0	14 x 8	13	54.5	24 x 14	20	152.0
80 x 32	64	0.6	150 x 50	102	2.7	350 x 200	330	24.7	600 x 350	508	68.9
3 x 1 ½	2 ½	1.3	6 x 2 ½	4	6.0	14 x 10	13	55.7	24 x 16	20	153.0
80 x 40	64	0.6	150 x 65	102	2.7	350 x 250	330	25.3	600 x 400	508	69.4
3 x 2	2 ½ C	1.4	6 x 3	4 C	5.4	14 x 12	13	57.3	24 x 18	20	154.0
80 x 50	64	0.6	150 x 80	102	2.4	350 x 300	330	26.0	600 x 450	508	69.9
3 x 2 ½	2 ½ C	1.5	6 x 4	4 C	5.6	16 x 8	14	65.4	24 x 20	20	155.0
80 x 65	64	0.7	150 x 100	102	2.5	400 x 200	356	29.7	600 x 500	508	70.3
3 ½ x 3	3	1.8	6 x 5	4 C	6.0	16 x 10	14	66.7			
90 x 80	76	0.8	150 x 125	102	2.7	400 x 250	356	30.3			
4 x 1	3	2.2	8 x 3	5	12.0	16 x 12	14	68.1			
100 x 25	76	1.0	200 x 80	127	5.5	400 x 300	356	30.9			
4 x 1 ¼	3	2.2	8 x 4	5 C	9.0	16 x 14	14	71.0			
100 x 32	76	1.0	200 x 100	127	4.1	400 x 350	356	32.2			

Note:

See Fitting Size chart on previous page for O.D



For Listings/Approval Details and Limitations, visit our website at www.asc-es.com or contact an ASC Engineered Solutions™ Sales Representative.



Fig. 7069 45° Lateral
Fig. 7070 45° Reducing Lateral

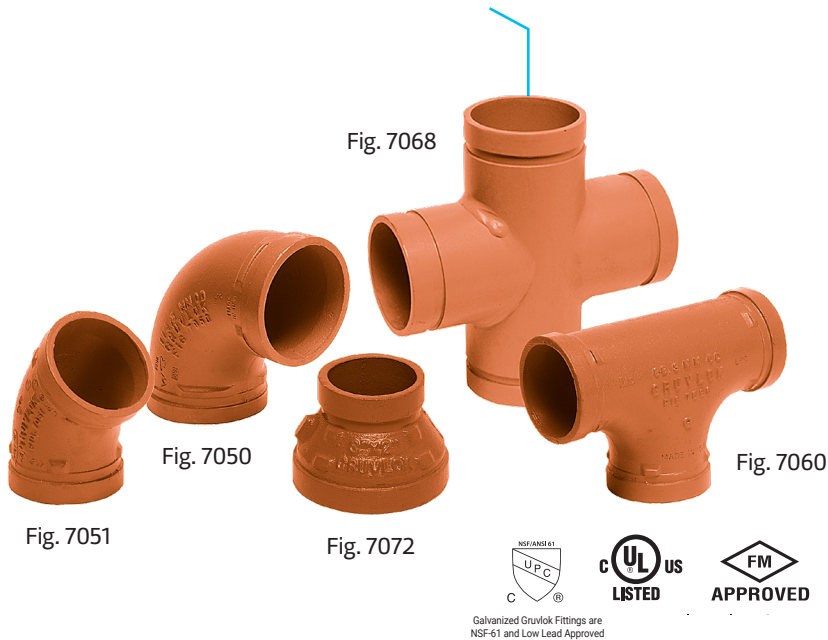

Material Specifications

Cast Fittings

Ductile iron conforming to ASTM A536, Grade 65-45-12

Malleable iron conforming to ASTM A47

Fabricated Fittings

1-12" Carbon steel, Schedule 40, conforming to ASTM A53, Grade B

14-24" Carbon steel, 0.375 wall, conforming to ASTM A53, Grade B

Coatings

Rust inhibiting paint

Color: Orange (standard)

Hot Dipped Zinc Galvanized conforming to ASTM A153 (optional)

Other Colors Available (IE: RAL3000 and RAL9000)

Gruvlok fittings are available through 24" nominal pipe size in a variety of styles. Use the Fitting Size Table to convert nominal pipe size to corresponding pipe O.D.

These fittings are designed to provide minimum pressure drop and uniform strength.

Depending on styles and size, Gruvlok fittings are provided in various materials including ductile iron, forged steel or fabricated steel.

Pressure ratings of Gruvlok standard fittings conform to those of Fig. 7001 Gruvlok coupling.

For Listings/Approval Details and Limitations, visit our website at www.asc-es.com or contact an ASC Engineered Solutions™ Sales Representative.

Lateral & Reducing Lateral Fig. 7069, 7070

Flow Data - Frictional Resistance (Expressed as Equivalent Straight Pipe)

Nominal Size	O.D.	Pipe Wall Thickness	Elbow		Tee	
			90°	45°	Branch	Run
In./DN(mm)	In./mm	In./mm	Ft./m	Ft./m	Ft./m	Ft./m
1	1.315	0.133	1.7	0.9	4.4	1.7
25	33.4	3.4	0.5	0.3	1.3	0.5
1¼	1.660	0.140	2.3	1.2	5.8	2.3
32	42.2	3.6	0.7	0.4	1.8	0.7
1½	1.900	0.145	2.7	1.3	6.7	2.7
40	48.3	3.7	0.8	0.4	2.0	0.8
2	2.375	0.154	3.4	1.7	8.6	3.4
50	60.3	3.9	1.0	0.5	2.6	1.0
2½	2.875	0.203	4.1	2.1	10.3	4.1
65	73.0	5.2	1.2	0.6	3.1	1.2
3 O.D.	2.996	0.197	4.3	2.2	10.8	4.3
76.1	76.1	5.0	1.3	0.7	3.3	1.3
3	3.500	0.216	5.1	2.6	12.8	5.1
80	88.9	5.5	1.6	0.8	3.9	1.6
4¼ O.D.	4.250	0.220	6.4	3.2	16.1	6.4
108.0	108.0	5.6	2.0	1.0	4.9	2.0
4	4.500	0.237	6.7	3.4	16.8	6.7
100	114.3	6.0	2.0	1.0	5.1	2.0
5¼ O.D.	5.236	0.248	8.0	4.0	20.1	8.0
133.0	133.0	6.3	2.4	1.2	6.1	2.4
5½ O.D.	5.500	0.248	8.3	4.2	20.9	8.3
139.7	139.7	6.3	2.5	1.3	6.4	2.5
5	5.563	0.258	8.4	4.2	21.0	8.4
125	141.3	6.6	2.6	1.3	6.4	2.6
6¼ O.D.	6.259	0.280	9.7	4.9	24.3	9.7
159.0	159.0	7.1	3.0	1.5	7.4	3.0
6½ O.D.	6.500	0.280	10.0	5.0	24.9	10.0
165.1	165.1	7.1	3.0	1.5	7.6	3.0
6	6.625	0.280	10.1	5.1	25.3	10.1
150	168.3	7.1	3.1	1.6	7.7	3.1
8	8.625	0.322	13.3	6.7	33.3	13.3
200	219.1	8.2	4.1	2.0	10.1	4.1
10	10.750	0.365	16.7	8.4	41.8	16.7
250	273.1	9.3	5.1	2.6	12.7	5.1
12	12.750	0.375	20.0	10.0	50.0	20.0
300	323.9	9.5	6.1	3.0	15.2	6.1
14	14.000	0.375	22.2	11.1	55.5	22.2
350	355.6	9.5	6.8	3.4	19.6	6.8
16	16.000	0.375	25.5	12.8	64.0	25.5
400	406.4	9.5	7.8	3.9	22.5	7.8
18	18.000	0.375	28.9	14.5	72.0	28.9
450	457.2	9.5	8.8	4.4	26.6	8.8
20	20.000	0.375	32.2	16.1	80.0	32.2
500	508.0	9.5	9.8	4.9	29.7	9.8
24	24.000	0.375	38.9	19.5	97.0	38.9
600	609.6	9.5	11.9	5.9	34.4	11.9

Note:

For the reducing tee and branches, use the value that is corresponding to the branch size.
For example: for 6" x 6" x 3" tee, the branch value of 3" is 12.8 ft. (3.9).

The Fitting Size Chart is used to determine the O.D. of the pipe that the fittings is to be used with.
Gruvlok Fittings are identified by either the Nominal size in inches or the Pipe O.D. in/mm.

Fitting Size

Nominal Size	O.D.
In./DN(mm)	In./mm
1	1.315
25	33.4
1¼	1.660
32	42.4
1½	1.900
40	48.3
2	2.375
50	60.3
2½	2.875
65	73.0
3 O.D.	2.996
76.1	76.1
3	3.500
80	88.9
3½	4.000
90	101.6
4¼ O.D.	4.250
108.0	108.0
4	4.500
100	114.3
5¼ O.D.	5.236
133.0	133.0
5½ O.D.	5.500
139.7	139.7
5	5.563
140	141.3
6¼ O.D.	6.259
159.0	159.0
6½ O.D.	6.500
165.1	165.1
6	6.625
150	168.3
8	8.625
200	219.1
10	10.750
250	273.0
12	12.750
300	323.9
14	14.000
350	355.6
16	16.000
400	406.4
18	18.000
450	457.2
20	20.000
500	508.0
24	24.000
600	609.6

Fig. 7069
45° Lateral

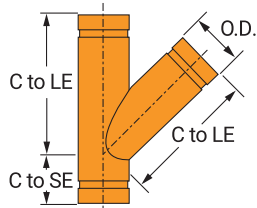
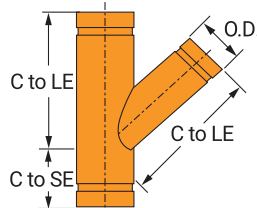

Fig. 7070
45° Reducing Lateral



Nominal Size	O.D.	Center to Long End	Center to Short End	Approx. Wt. Ea.
In./DN(mm)	In./mm	In./mm	In./mm	Lbs./kg
1	1.315	5	2¼	1.5
25	33.4	127	57	0.7
1¼	1.660	5¾	2½	2.5
32	42.2	146	64	1.1
1½	1.900	6¼	2¾	3.5
40	48.3	159	70	1.6
2	2.375	7	2¾	4.5
50	60.3	178	70	2.0
2½	2.875	7¾	3	10.0
65	73.0	197	76	4.5
3	3.500	8½	3¼	11.0
80	88.9	216	83	5.0
3½	4.000	10	3½	14.0
90	101.6	254	89	6.4
4	4.500	10½	3¾	18.3
100	114.3	267	95	8.3
5	5.563	12½	4	30.0
125	141.3	318	102	13.6
6	6.625	14	4½	46.6
150	168.3	356	114	21.1
8	8.625	18	6	82.8
200	219.1	457	152	37.6
10	10.750	20½	6½	127.0
250	273.1	521	165	57.4

Nominal Size	Center to Long End	Center to Short End	Approx. Wt. Ea.
In./DN(mm)	In./mm	In./mm	Lbs./kg
3 x 3 x 2	8½	3¼	9.8
80 x 80 x 50	216	83	4.4
3 x 3 x 2½	8½	3¼	11.5
80 x 80 x 65	216	83	5.2
4 x 4 x 2	10½	3¾	15.5
100 x 100 x 50	267	95	7.0
4 x 4 x 2½	10½	3¾	17.0
100 x 100 x 65	267	95	7.7
4 x 4 x 3	10½	3¾	18.5
100 x 100 x 80	267	95	8.4
5 x 5 x 2	12½	4	22.5
125 x 125 x 50	318	102	10.2
5 x 5 x 3	12½	4	26.5
125 x 125 x 80	318	102	12.0
5 x 5 x 4	12½	4	30.5
125 x 125 x 100	318	102	13.8
6 x 6 x 2	14	4½	33.0
150 x 150 x 50	356	114	15.0
6 x 6 x 3	14	4½	37.0
150 x 150 x 80	356	114	16.8
6 x 6 x 4	14	4½	40.0
150 x 150 x 100	356	114	18.1
6 x 6 x 5	14	4½	45.0
150 x 150 x 125	356	114	20.4

Nominal Size	Center to Long End	Center to Short End	Approx. Wt. Ea.
In./DN(mm)	In./mm	In./mm	Lbs./kg
12 x 12 x 10	23	7	168
300 x 300 x 250	584	178	76.2
14 x 14 x 4	26½	7½	173
350 x 350 x 100	673	191	78.5
14 x 14 x 6	26½	7½	185
350 x 350 x 150	673	191	83.9
14 x 14 x 8	26½	7½	195
350 x 350 x 200	673	191	88.5
14 x 14 x 10	26½	7½	223
350 x 350 x 250	673	191	101.0
14 x 14 x 12	26½	7½	240
350 x 350 x 300	673	191	109.0
16 x 16 x 6	29	8	235
400 x 400 x 150	737	203	107.0
16 x 16 x 8	29	8	250
400 x 400 x 200	737	203	113.0
16 x 16 x 10	29	8	263
400 x 400 x 250	737	203	119.0
16 x 16 x 12	29	8	283
400 x 400 x 300	737	203	128.0
16 x 16 x 14	29	8	307
400 x 400 x 350	737	203	139.0
18 x 18 x 6	32	8½	275
450 x 450 x 150	813	216	125.0

Note:
See Fitting Size chart on previous page for O.D.



For Listings/Approval Details and Limitations, visit our website at www.asc-es.com or contact an ASC Engineered Solutions™ Sales Representative.

Fig. 7069
45° Lateral

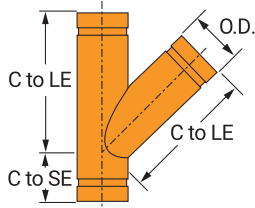

Nominal Size	O.D.	Center to Long End	Center to Short End	Approx. Wt. Ea.
In./DN(mm)	In./mm	In./mm	In./mm	Lbs./kg
12	12.750	23	7	165.0
300	323.9	584	178	74.8
14	14.000	26½	7½	215.0
350	355.6	673	191	97.5
16	16.000	29	8	345.0
400	406.4	737	203	157.0
18	18.000	32	8½	425.0
450	457.2	813	216	193.0
20	20.000	35	9	517.0
500	508.0	889	229	235
24	24.000	40	10	940.0
600	609.6	1016	254	426

Note:
See Fitting Size chart on page 2 for O.D.



For Listings/Approval Details and Limitations, visit our website at www.asc-es.com or contact an ASC Engineered Solutions™ Sales Representative.

Fig. 7070
45° Reducing Lateral

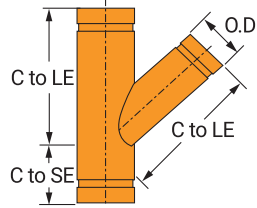

Nominal Size	Center to Long End	Center to Short End	Approx. Wt. Ea.
In./DN(mm)	In./mm	In./mm	Lbs./kg
8 x 8 x 4	18	6	59.6
200 x 200 x 100	457	152	27.0
8 x 8 x 5	18	6	68.0
200 x 200 x 125	457	152	30.8
8 x 8 x 6	18	6	75.0
200 x 200 x 150	457	152	34.0
10 x 10 x 4	20½	6½	83.0
250 x 250 x 100	521	165	37.6
10 x 10 x 5	20½	6½	100.0
250 x 250 x 125	521	165	45.4
10 x 10 x 6	20½	6½	105.0
250 x 250 x 150	521	165	47.6
10 x 10 x 8	20½	6½	116.0
250 x 250 x 200	521	165	52.6
12 x 12 x 4	23	7	137.0
300 x 300 x 100	584	178	62.1
12 x 12 x 5	23	7	138.0
300 x 300 x 125	584	178	62.6
12 x 12 x 6	23	7	140.0
300 x 300 x 150	584	178	63.5
12 x 12 x 8	23	7	147.0
300 x 300 x 200	584	178	66.7

Nominal Size	Center to Long End	Center to Short End	Approx. Wt. Ea.
In./DN(mm)	In./mm	In./mm	Lbs./kg
18 x 18 x 8	32	8½	306
450 x 450 x 200	813	216	139.0
18 x 18 x 10	32	8½	321
450 x 450 x 250	813	216	146.0
18 x 18 x 12	32	8½	333
450 x 450 x 300	813	216	151.0
18 x 18 x 14	32	8½	358
450 x 450 x 350	813	216	162.0
18 x 18 x 16	32	8½	382
450 x 450 x 400	813	216	173.0
20 x 20 x 12	35	9	390
500 x 500 x 300	889	229	177.0
20 x 20 x 14	35	9	410
500 x 500 x 350	889	229	186.0
20 x 20 x 16	35	9	440
500 x 500 x 400	889	229	200.0
24 x 24 x 16	40	10	725
600 x 600 x 400	1016	254	329.0
24 x 24 x 20	40	10	785
600 x 600 x 500	1016	254	356.0

- Fig. 7066** Tee Wye
- Fig. 7067** Reducing Tee Wye
- Fig. 7071** True Wye

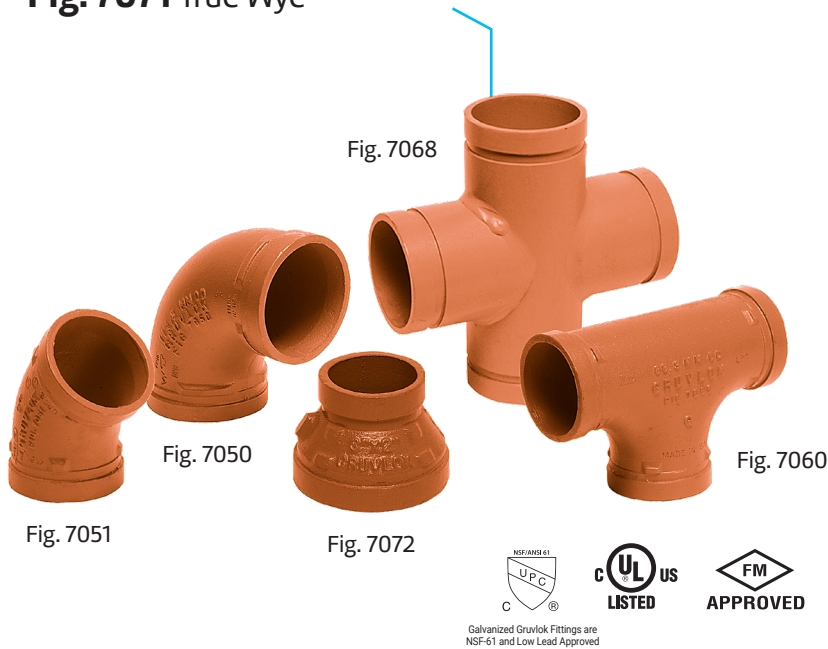

Material Specifications

Cast Fittings

Ductile iron conforming to ASTM A536, Grade 65-45-12

Malleable iron conforming to ASTM A47

Fabricated Fittings

1-12" Carbon steel, Schedule 40, conforming to ASTM A53, Grade B

14-24" Carbon steel, 0.375 wall, conforming to ASTM A53, Grade B

Coatings

Rust inhibiting paint
Color: Orange (standard)

Hot Dipped Zinc Galvanized conforming to ASTM A153 (optional)

Other Colors Available
(IE: RAL3000 and RAL9000)

Gruvlok fittings are available through 24" nominal pipe size in a variety of styles. Use the Fitting Size Table to convert nominal pipe size to corresponding pipe O.D.

These fittings are designed to provide minimum pressure drop and uniform strength.

Depending on styles and size, Gruvlok fittings are provided in various materials including ductile iron, forged steel or fabricated steel.

Pressure ratings of Gruvlok standard fittings conform to those of Fig. 7001 Gruvlok coupling.

For Listings/Approval Details and Limitations, visit our website at www.asc-es.com or contact an ASC Engineered Solutions™ Sales Representative.

Tee Wye, Reducing Tee Wye & True Wye Fig. 7066, 7067, 7071

Flow Data - Frictional Resistance (Expressed as Equivalent Straight Pipe)

Nominal Size	O.D.	Pipe Wall Thickness	Elbow		Tee	
			90°	45°	Branch	Run
In./DN(mm)	In./mm	In./mm	Ft./m	Ft./m	Ft./m	Ft./m
1	1.315	0.133	1.7	0.9	4.4	1.7
25	33.4	3.4	0.5	0.3	1.3	0.5
1 ¼	1.660	0.140	2.3	1.2	5.8	2.3
32	42.2	3.6	0.7	0.4	1.8	0.7
1 ½	1.900	0.145	2.7	1.3	6.7	2.7
40	48.3	3.7	0.8	0.4	2.0	0.8
2	2.375	0.154	3.4	1.7	8.6	3.4
50	60.3	3.9	1.0	0.5	2.6	1.0
2 ½	2.875	0.203	4.1	2.1	10.3	4.1
65	73.0	5.2	1.2	0.6	3.1	1.2
3 O.D.	2.996	0.197	4.3	2.2	10.8	4.3
76.1	76.1	5.0	1.3	0.7	3.3	1.3
3	3.500	0.216	5.1	2.6	12.8	5.1
80	88.9	5.5	1.6	0.8	3.9	1.6
4 ¼ O.D.	4.250	0.220	6.4	3.2	16.1	6.4
108.0	108.0	5.6	2.0	1.0	4.9	2.0
4	4.500	0.237	6.7	3.4	16.8	6.7
100	114.3	6.0	2.0	1.0	5.1	2.0
5 ¼ O.D.	5.236	0.248	8.0	4.0	20.1	8.0
133.0	133.0	6.3	2.4	1.2	6.1	2.4
5 ½ O.D.	5.500	0.248	8.3	4.2	20.9	8.3
139.7	139.7	6.3	2.5	1.3	6.4	2.5
5	5.563	0.258	8.4	4.2	21.0	8.4
125	141.3	6.6	2.6	1.3	6.4	2.6
6 ¼ O.D.	6.259	0.280	9.7	4.9	24.3	9.7
159.0	159.0	7.1	3.0	1.5	7.4	3.0
6 ½ O.D.	6.500	0.280	10.0	5.0	24.9	10.0
165.1	165.1	7.1	3.0	1.5	7.6	3.0
6	6.625	0.280	10.1	5.1	25.3	10.1
150	168.3	7.1	3.1	1.6	7.7	3.1
8	8.625	0.322	13.3	6.7	33.3	13.3
200	219.1	8.2	4.1	2.0	10.1	4.1
10	10.750	0.365	16.7	8.4	41.8	16.7
250	273.1	9.3	5.1	2.6	12.7	5.1
12	12.750	0.375	20.0	10.0	50.0	20.0
300	323.9	9.5	6.1	3.0	15.2	6.1
14	14.000	0.375	22.2	11.1	55.5	22.2
350	355.6	9.5	6.8	3.4	19.6	6.8
16	16.000	0.375	25.5	12.8	63.9	25.5
400	406.4	9.5	7.8	3.9	22.5	7.8
18	18.000	0.375	28.9	14.5	71.2	28.9
450	457.2	9.5	8.8	4.4	26.6	8.8
20	20.000	0.375	32.2	16.1	79.3	32.2
500	508.0	9.5	9.8	4.9	29.7	9.8
24	24.000	0.375	38.9	19.5	95.7	38.9
600	609.6	9.5	11.9	5.9	34.4	11.9

Note:

For the reducing tee and branches, use the value that is corresponding to the branch size. For example: for 6" x 6" x 3" tee, the branch value of 3" is 12.8 ft (3.9).

The Fitting Size Chart is used to determine the O.D. of the pipe that the fittings is to be used with. Gruvlok Fittings are identified by either the Nominal size in inches or the Pipe O.D. in/mm.

Fitting Size

Nominal Size	O.D.
In./DN(mm)	In./mm
1	1.315
25	33.4
1 ¼	1.660
32	42.4
1 ½	1.900
40	48.3
2	2.375
50	60.3
2 ½	2.875
65	73.0
3 O.D.	2.996
76.1	76.1
3	3.500
80	88.9
3 ½	4.000
90	101.6
4 ¼ O.D.	4.250
108.0	108.0
4	4.500
100	114.3
5 ¼ O.D.	5.236
133.0	133.0
5 ½ O.D.	5.500
139.7	139.7
5	5.563
140	141.3
6 ¼ O.D.	6.259
159.0	159.0
6 ½ O.D.	6.500
165.1	165.1
6	6.625
150	168.3
8	8.625
200	219.1
10	10.750
250	273.0
12	12.750
300	323.9
14	14.000
350	355.6
16	16.000
400	406.4
18	18.000
450	457.2
20	20.000
500	508.0
24	24.000
600	609.6

Fig. 7066
Tee Wye

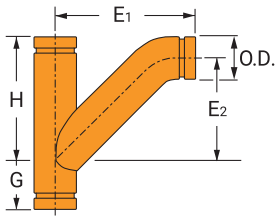

Fig. 7071
True Wye

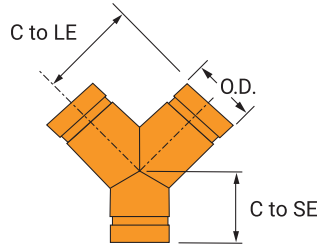
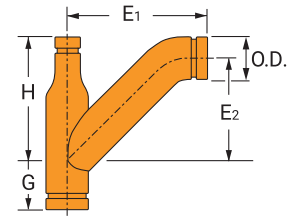

Fig. 7067
Reducing Tee Wye



Nominal Size	G	H	E1	E2	Approx. Wt. Ea.
In./DN(mm)	In./mm	In./mm	In./mm	In./mm	Lbs./kg
2 x 2 x 2 50 x 50 x 50	2¾ 70	7 178	9 229	4⅝ 117	6.4 2.9
2½ x 2½ x 2½ 65 x 65 x 65	3 76	7¾ 197	10½ 267	5¾ 146	11.5 5.2
3 x 3 x 3 80 x 80 x 80	3¼ 83	8½ 216	11½ 292	6½ 165	16.5 7.5
3½ x 3½ x 3½ 90 x 90 x 90	3½ 89	10 254	13 330	7¾ 197	22.0 10.0
4 x 4 x 3 100 x 100 x 80	3¾ 95	10½ 267	12⅞ 327	7⅞ 200	23.0 10.4
4 x 4 x 4 100 x 100 x 100	3¾ 95	10½ 267	13⅝ 346	8⅞ 206	26.0 11.8
5 x 5 x 3 125 x 125 x 80	4 102	12½ 318	14¼ 362	9¼ 235	32.0 14.5
5 x 5 x 4 125 x 125 x 100	4 102	12½ 318	15⅞ 384	9⅞ 244	35.0 15.9
5 x 5 x 5 125 x 125 x 125	4 102	12½ 318	16⅞ 410	10 254	40.0 18.1
6 x 6 x 3 150 x 150 x 80	4½ 114	14 356	15⅝ 389	10⅝ 262	50.0 22.7
6 x 6 x 4 150 x 150 x 100	4½ 114	14 356	16¼ 413	10¾ 273	55.0 24.9
6 x 6 x 5 150 x 150 x 125	4½ 114	14 356	17¼ 438	11⅞ 283	58.0 26.3
6 x 6 x 6 150 x 150 x 150	4½ 114	14 356	18¼ 464	11½ 292	60.5 27.4

Nominal Size	O.D.	Center to Long End	Center to Short End	Approx. Wt. Ea.
In./DN(mm)	In./mm	In./mm	In./mm	Lbs./kg
1 25	1.315 33.4	2¼ 57	2¼ 57	1.1 0.5
1¼ 32	1.660 42.2	2¾ 70	2½ 64	1.5 0.7
1½ 40	1.900 48.3	2¾ 70	2¾ 70	1.8 0.8
2 50	2.375 60.3	3¼ 83	2¾ 70	2.3 1.0
2½ 65	2.875 73	3¾ 95	3 76	5.0 2.3
3 80	3.500 88.9	4¼ 108	3¼ 83	6.1 2.8
3½ 90	4.000 101.6	4½ 114	3½ 89	8.3 3.8
4 100	4.500 114.3	5 127	3¾ 95	10.5 4.8
5 125	5.563 141.3	5½ 140	4 102	15.0 6.8
6 150	6.625 168.3	6½ 165	4½ 114	21.6 9.8
8 200	8.625 219.1	7¾ 197	6 152	36.0 16.3
10 250	10.750 273.1	9 229	6½ 165	51.0 23.1
12 300	12.750 323.9	10 254	7 178	160.0 72.6

Nominal Size	G	H	E1	E2	Approx. Wt. Ea.
In./DN(mm)	In./mm	In./mm	In./mm	In./mm	Lbs./kg
4 x 3 x 3 100 x 80 x 80	1⅝ 41	7⅞ 187	10¾ 273	5⅝ 143	16.0 7.3
4 x 3 x 4 100 x 80 x 100	3¾ 95	10½ 267	13⅝ 346	8⅞ 206	27.0 12.2
5 x 3 x 3 125 x 80 x 80	1¼ 32	9¾ 248	11½ 292	6½ 165	25.0 11.3
5 x 3 x 5 125 x 80 x 125	4 102	12½ 318	16⅞ 410	10 254	44.0 20.0
5 x 4 x 3 125 x 100 x 80	1⅞ 48	9⅞ 232	11⅞ 302	6⅞ 175	21.0 9.5
5 x 4 x 4 125 x 100 x 100	1⅞ 48	9⅞ 232	12¾ 324	7¼ 184	25.0 11.3
6 x 4 x 6 150 x 100 x 150	4½ 114	14 356	18¼ 464	11½ 292	61.0 27.7
6 x 5 x 3 150 x 125 x 80	1¼ 32	10¾ 273	13 330	8 203	27.0 12.2
6 x 5 x 4 150 x 125 x 100	1¼ 32	10¾ 273	13⅞ 352	8⅞ 213	31.0 14.1
8 x 6 x 4 200 x 150 x 100	1 25	12 305	14¾ 375	9¼ 235	45.0 20.4
8 x 6 x 8 200 x 150 x 200	6 152	18 457	23¼ 591	15¼ 387	95.0 43.1

Note:
See Fitting Size chart on previous page for O.D.



For Listings/Approval Details and Limitations, visit our website at www.asc-es.com or contact an ASC Engineered Solutions™ Sales Representative.

Fig. 7066
Tee Wye

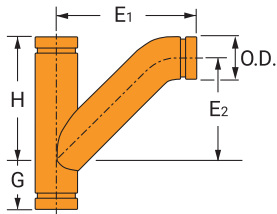

Nominal Size	G	H	E1	E2	Approx. Wt. Ea.
In./DN(mm)	In./mm	In./mm	In./mm	In./mm	Lbs./kg
8 x 8 x 3 200 x 200 x 80	6 152	18 457	18 ³ / ₁₆ 462	13 ³ / ₁₆ 335	100.0 45.4
8 x 8 x 4 200 x 200 x 100	6 152	18 457	19 483	13 ¹ / ₂ 343	110.0 49.9
8 x 8 x 5 200 x 200 x 125	6 152	18 457	20 508	13 ⁷ / ₈ 352	111.0 50.3
8 x 8 x 6 200 x 200 x 150	6 152	18 457	21 ¹ / ₈ 537	14 ³ / ₈ 365	112.0 50.8
8 x 8 x 8 200 x 200 x 200	6 152	18 457	23 ¹ / ₄ 591	15 ¹ / ₄ 387	120 54.4
10 x 10 x 3 250 x 250 x 80	6 ¹ / ₂ 165	20 ¹ / ₂ 521	19 ⁷ / ₈ 505	14 ⁷ / ₈ 378	130.0 59.0
10 x 10 x 4 250 x 250 x 100	6 ¹ / ₂ 165	20 ¹ / ₂ 521	20 ³ / ₄ 527	15 ¹ / ₄ 387	135.0 61.2
10 x 10 x 5 250 x 250 x 125	6 ¹ / ₂ 165	20 ¹ / ₂ 521	21 ⁷ / ₈ 556	15 ³ / ₄ 400	140.0 63.5
10 x 10 x 6 250 x 250 x 150	6 ¹ / ₂ 165	20 ¹ / ₂ 521	21 ⁷ / ₈ 581	16 ¹ / ₈ 410	145.0 65.8
10 x 10 x 8 250 x 250 x 200	6 ¹ / ₂ 165	20 ¹ / ₂ 521	27 ¹ / ₄ 692	19 ¹ / ₄ 489	150.0 68.0
10 x 10 x 10 250 x 250 x 250	6 ¹ / ₂ 165	20 ¹ / ₂ 521	27 ¹ / ₄ 692	18 457	190.0 86.2
12 x 12 x 12 300 x 300 x 300	7 178	23 584	31 787	20 ¹ / ₂ 521	240.0 109.0

Note:
See Fitting Size chart on previous page for O.D.

Fig. 7071
True Wye

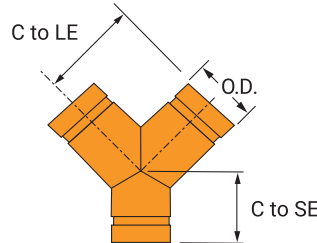

Nominal Size	O.D.	Center to Long End	Center to Short End	Approx. Wt. Ea.
In./DN(mm)	In./mm	In./mm	In./mm	Lbs./kg
14 350	14.000 355.6	11 279	7 ¹ / ₂ 191	136.0 61.7
16 400	16.00 406.4	12 305	8 203	166.0 75.3
18 450	18.000 457.2	15 ¹ / ₂ 394	8 ¹ / ₂ 216	234.0 106.0
20 500	20.000 508.0	17 ¹ / ₄ 438	9 229	281.0 128.0
24 600	24.000 609.6	20 508	10 254	523.0 237.0



For Listings/Approval Details and Limitations, visit our website at www.asc-es.com or contact an ASC Engineered Solutions™ Sales Representative.

- Introduction
- Couplings
- Outlets
- Fittings**
- Valves & Accessories
- High Pressure
- CTS Copper System
- DI-Electric Nipples
- Plan-End Fittings
- HDPE Couplings
- Socket-It® Fittings
- Stainless Steel Method
- Roll Groovers
- Installation & Assembly
- Special Coatings
- Design Services
- Technical Data
- Master Format 3 Part Specs.
- Pictorial Index

- Fig. 7055** 90° Adapter Elbow
- Fig. 7056** 45° Adapter Elbow
- Fig. 7087** Female Thread Adapter

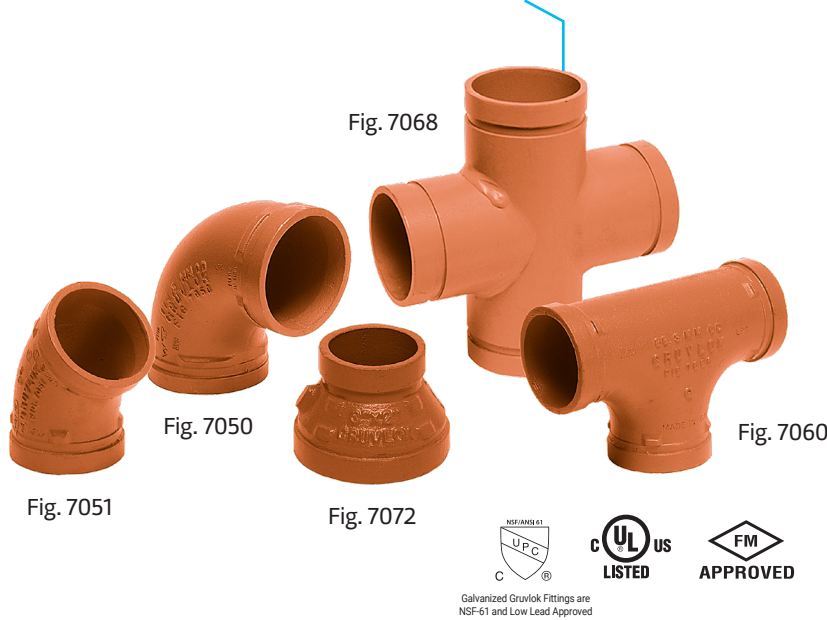

Material Specifications

Cast Fittings

Ductile iron conforming to ASTM A536, Grade 65-45-12

Malleable iron conforming to ASTM A47

Fabricated Fittings

1-12" Carbon steel, Schedule 40, conforming to ASTM A53, Grade B

14-24" Carbon steel, 0.375 wall, conforming to ASTM A53, Grade B

Coatings

Rust inhibiting paint

Color: Orange (standard)

Hot Dipped Zinc Galvanized conforming to ASTM A153 (optional)

Other Colors Available (IE: RAL3000 and RAL9000)

Gruvlok fittings are available through 24" nominal pipe size in a variety of styles. Use the Fitting Size Table to convert nominal pipe size to corresponding pipe O.D.

These fittings are designed to provide minimum pressure drop and uniform strength.

Depending on styles and size, Gruvlok fittings are provided in various materials including ductile iron, forged steel or fabricated steel.

Pressure ratings of Gruvlok standard fittings conform to those of Fig. 7001 Gruvlok coupling.

For Listings/Approval Details and Limitations, visit our website at www.asc-es.com or contact an ASC Engineered Solutions™ Sales Representative.

Adapter Elbows & Female Thread Adapter Fig. 7055, 7056, 7087

Flow Data - Frictional Resistance (Expressed as Equivalent Straight Pipe)

Nominal Size	O.D.	Pipe Wall Thickness	Elbow		Tee	
			90°	45°	Branch	Run
In./DN(mm)	In./mm	In./mm	Ft./m	Ft./m	Ft./m	Ft./m
1	1.315	0.133	1.7	0.9	4.4	1.7
25	33.4	3.4	0.5	0.3	1.3	0.5
1 ¼	1.660	0.140	2.3	1.2	5.8	2.3
32	42.2	3.6	0.7	0.4	1.8	0.7
1 ½	1.900	0.145	2.7	1.3	6.7	2.7
40	48.3	3.7	0.8	0.4	2.0	0.8
2	2.375	0.154	3.4	1.7	8.6	3.4
50	60.3	3.9	1.0	0.5	2.6	1.0
2 ½	2.875	0.203	4.1	2.1	10.3	4.1
65	73.0	5.2	1.2	0.6	3.1	1.2
3 O.D.	2.996	0.197	4.3	2.2	10.8	4.3
76.1	76.1	5.0	1.3	0.7	3.3	1.3
3	3.500	0.216	5.1	2.6	12.8	5.1
80	88.9	5.5	1.6	0.8	3.9	1.6
4 ¼ O.D.	4.250	0.220	6.4	3.2	16.1	6.4
108.0	108.0	5.6	2.0	1.0	4.9	2.0
4	4.500	0.237	6.7	3.4	16.8	6.7
100	114.3	6.0	2.0	1.0	5.1	2.0
5 ¼ O.D.	5.236	0.248	8.0	4.0	20.1	8.0
133.0	133.0	6.3	2.4	1.2	6.1	2.4
5 ½ O.D.	5.500	0.248	8.3	4.2	20.9	8.3
139.7	139.7	6.3	2.5	1.3	6.4	2.5
5	5.563	0.258	8.4	4.2	21.0	8.4
125	141.3	6.6	2.6	1.3	6.4	2.6
6 ¼ O.D.	6.259	0.280	9.7	4.9	24.3	9.7
159.0	159.0	7.1	3.0	1.5	7.4	3.0
6 ½ O.D.	6.500	0.280	10.0	5.0	24.9	10.0
165.1	165.1	7.1	3.0	1.5	7.6	3.0
6	6.625	0.280	10.1	5.1	25.3	10.1
150	168.3	7.1	3.1	1.6	7.7	3.1
8	8.625	0.322	13.3	6.7	33.3	13.3
200	219.1	8.2	4.1	2.0	10.1	4.1
10	10.750	0.365	16.7	8.4	41.8	16.7
250	273.1	9.3	5.1	2.6	12.7	5.1
12	12.750	0.375	20.0	10.0	50.0	20.0
300	323.9	9.5	6.1	3.0	15.2	6.1
14	14.000	0.375	22.2	11.1	55.5	22.2
350	355.6	9.5	6.8	3.4	17.6	6.8
16	16.000	0.375	25.5	12.8	63.9	25.5
400	406.4	9.5	7.8	3.9	22.5	7.8
18	18.000	0.375	28.9	14.5	71.2	28.9
450	457.2	9.5	8.8	4.4	26.6	8.8
20	20.000	0.375	32.2	16.1	79.5	32.2
500	508.0	9.5	9.8	4.9	29.7	9.8
24	24.000	0.375	38.9	19.5	95.7	38.9
600	609.6	9.5	11.9	5.9	34.4	11.9

Note:

For the reducing tee and branches, use the value that is corresponding to the branch size. For example: for 6" x 6" x 3" tee, the branch value of 3" is 12.8 ft (3.9).

The Fitting Size Chart is used to determine the O.D. of the pipe that the fittings is to be used with. Gruvlok Fittings are identified by either the Nominal size in inches or the Pipe O.D. in/mm.

Fitting Size

Nominal Size	O.D.
In./DN(mm)	In./mm
1	1.315
25	33.4
1 ¼	1.660
32	42.4
1 ½	1.900
40	48.3
2	2.375
50	60.3
2 ½	2.875
65	73.0
3 O.D.	2.996
76.1	76.1
3	3.500
80	88.9
3 ½	4.000
90	101.6
4 ¼ O.D.	4.250
108.0	108.0
4	4.500
100	114.3
5 ¼ O.D.	5.236
133.0	133.0
5 ½ O.D.	5.500
139.7	139.7
5	5.563
140	141.3
6 ¼ O.D.	6.259
159.0	159.0
6 ½ O.D.	6.500
165.1	165.1
6	6.625
150	168.3
8	8.625
200	219.1
10	10.750
250	273.0
12	12.750
300	323.9
14	14.000
350	355.6
16	16.000
400	406.4
18	18.000
450	457.2
20	20.000
500	508.0
24	24.000
600	609.6

Fig. 7087 GR X FPT
Female Thread Adapter

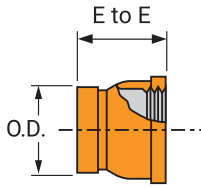

Nominal Size	Grooved End O.D.	End to End	Approx. Wt. Ea.
In./DN(mm)	In./mm	In./mm	Lbs./kg
1	1.315	2 ¹ / ₁₆	0.7
25	33.4	52	0.3
1 ¹ / ₄	1.660	2 ⁵ / ₁₆	1.4
32	42.2	59	0.6
1 ¹ / ₂	1.900	2 ⁵ / ₁₆	1.5
40	48.3	59	0.7
2	2.375	2 ¹ / ₂	1.6
50	60.3	64	0.7
2 ¹ / ₂	2.875	2 ³ / ₄	1.6
65	73.0	70	0.7
3	3.500	2 ³ / ₄	2.5
80	88.9	70	1.1
4	4.500	3 ¹ / ₄	4.5
100	114.3	83	2.0

Note:
This product is not UL/ULC Listed or FM Approved.

Fig. 7055 GR X MPT
90° Adapter Elbow

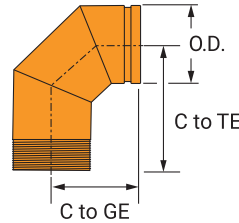

Nominal Size	Fitting O.D.	Center to Grooved End	Center to Threaded End	Approx. Wt. Ea.
In./DN(mm)	In./mm	In./mm	In./mm	Lbs./kg
1	1.315	2 ¹ / ₄	2 ¹ / ₄	0.6
25	33.4	57	57	0.3
1 ¹ / ₄	1.660	2 ³ / ₄	2 ³ / ₄	1.0
32	42.2	70	70	0.5
1 ¹ / ₂	1.900	2 ³ / ₄	2 ³ / ₄	1.2
40	48.3	70	70	0.5
2	2.375	3 ¹ / ₄	4 ¹ / ₄	2.3
50	60.3	83	108	1.0
2 ¹ / ₂	2.875	3 ³ / ₄	3 ³ / ₄	3.7
65	73.0	95	95	1.7
3	3.500	4 ¹ / ₄	6	6.5
80	88.9	108	152	2.9
3 ¹ / ₂	4.000	4 ¹ / ₂	6 ¹ / ₄	8.2
90	101.6	114	159	3.7
4	4.500	5	7 ¹ / ₄	11
100	114.3	127	184	5.0
6	6.625	6 ¹ / ₂	6 ¹ / ₂	19.8
150	168.3	165	165	9.0

Fig. 7056 GR X MPT
45° Adapter Elbow

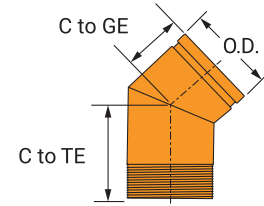

Nominal Size	Fitting O.D.	Center to Grooved End	Center to Threaded End	Approx. Wt. Ea.
In./DN(mm)	In./mm	In./mm	In./mm	Lbs./kg
1	1.315	1 ³ / ₄	1 ³ / ₄	0.6
25	33.4	44	44	0.3
1 ¹ / ₄	1.660	1 ³ / ₄	1 ³ / ₄	0.7
32	42.2	44	44	0.3
1 ¹ / ₂	1.900	1 ³ / ₄	1 ³ / ₄	0.8
40	48.3	44	44	0.4
2	2.375	2	3	1.6
50	60.3	51	76	0.7
2 ¹ / ₂	2.875	2 ¹ / ₄	2 ¹ / ₄	2.2
65	73.0	57	57	1.0
3	3.500	2 ¹ / ₂	4 ¹ / ₄	4.3
80	88.9	64	108	2.0
3 ¹ / ₂	4.000	2 ³ / ₄	2 ³ / ₄	4.2
90	101.6	70	70	1.9
4	4.500	3	5 ¹ / ₄	7.5
100	114.3	76	133	3.4
6	6.625	3 ¹ / ₂	3 ¹ / ₂	11.1
150	168.3	89	89	5.0



For Listings/Approval Details and Limitations, visit our website at www.asc-es.com or contact an ASC Engineered Solutions™ Sales Representative.

Fig. 7050RF GR x Flange
Reducing Base Support Elbow – Grooved x 150# Flanged

Fig. 7072GF GR x Flange
Concentric Reducer



Material Specifications

Cast Fittings

Ductile iron conforming to ASTM A536, Grade 65-45-12
Malleable iron conforming to ASTM A47

Fabricated Fittings

1-12" Carbon steel, Schedule 40, conforming to ASTM A53, Grade B
14-24" Carbon steel, 0.375 wall, conforming to ASTM A53, Grade B

Coatings

Rust inhibiting paint
Color: Orange (standard)
Hot Dipped Zinc Galvanized conforming to ASTM A153 (optional)
Other Colors Available (IE: RAL3000 and RAL9000)

Gruvlok fittings are available through 24" nominal pipe size in a variety of styles. Use the Fitting Size Table to convert nominal pipe size to corresponding pipe O.D.

These fittings are designed to provide minimum pressure drop and uniform strength.

Depending on styles and size, Gruvlok fittings are provided in various materials including ductile iron, forged steel or fabricated steel.

Pressure ratings of Gruvlok standard fittings conform to those of Fig. 7001 Gruvlok coupling.

For Listings/Approval Details and Limitations, visit our website at www.asc-es.com or contact an ASC Engineered Solutions™ Sales Representative.

- Introduction
- Couplings
- Outlets
- Fittings**
- Valves & Accessories
- High Pressure
- CTS Copper System
- DI-Electric Nipples
- Plan-End Fittings
- HDPE Couplings
- Socket-It® Fittings
- Stainless Steel Method
- Roll Groovers
- Installation & Assembly
- Special Coatings
- Design Services
- Technical Data
- Master Format 3 Part Specs.
- Pictorial Index

Reducing Base Support Elbow, Concentric Reducer Fig. 7050RF GR x Flange, 7072GR GR x Flange

Flow Data - Frictional Resistance (Expressed as Equivalent Straight Pipe)

Nominal Size	O.D.	Pipe Wall Thickness	Elbow		Tee	
			90°	45°	Branch	Run
In./DN(mm)	In./mm	In./mm	Ft./m	Ft./m	Ft./m	Ft./m
1	1.315	0.133	1.7	0.9	4.4	1.7
25	33.4	3.4	0.5	0.3	1.3	0.5
1 ¼	1.660	0.140	2.3	1.2	5.8	2.3
32	42.2	3.6	0.7	0.4	1.8	0.7
1 ½	1.900	0.145	2.7	1.3	6.7	2.7
40	48.3	3.7	0.8	0.4	2.0	0.8
2	2.375	0.154	3.4	1.7	8.6	3.4
50	60.3	3.9	1.0	0.5	2.6	1.0
2 ½	2.875	0.203	4.1	2.1	10.3	4.1
65	73.0	5.2	1.2	0.6	3.1	1.2
3 O.D.	2.996	0.197	4.3	2.2	10.8	4.3
76.1	76.1	5.0	1.3	0.7	3.3	1.3
3	3.500	0.216	5.1	2.6	12.8	5.1
80	88.9	5.5	1.6	0.8	3.9	1.6
4 ¼ O.D.	4.250	0.220	6.4	3.2	16.1	6.4
108.0	108.0	5.6	2.0	1.0	4.9	2.0
4	4.500	0.237	6.7	3.4	16.8	6.7
100	114.3	6.0	2.0	1.0	5.1	2.0
5 ¼ O.D.	5.236	0.248	8.0	4.0	20.1	8.0
133.0	133.0	6.3	2.4	1.2	6.1	2.4
5 ½ O.D.	5.500	0.248	8.3	4.2	20.9	8.3
139.7	139.7	6.3	2.5	1.3	6.4	2.5
5	5.563	0.258	8.4	4.2	21.0	8.4
125	141.3	6.6	2.6	1.3	6.4	2.6
6 ¼ O.D.	6.259	0.280	9.7	4.9	24.3	9.7
159.0	159.0	7.1	3.0	1.5	7.4	3.0
6 ½ O.D.	6.500	0.280	10.0	5.0	24.9	10.0
165.1	165.1	7.1	3.0	1.5	7.6	3.0
6	6.625	0.280	10.1	5.1	25.3	10.1
150	168.3	7.1	3.1	1.6	7.7	3.1
8	8.625	0.322	13.3	6.7	33.3	13.3
200	219.1	8.2	4.1	2.0	10.1	4.1
10	10.750	0.365	16.7	8.4	41.8	16.7
250	273.1	9.3	5.1	2.6	12.7	5.1
12	12.750	0.375	20.0	10.0	50.0	20.0
300	323.9	9.5	6.1	3.0	15.2	6.1
14	14.000	0.375	22.2	11.7	64.2	22.9
350	355.6	9.5	6.8	5.4	19.6	7.0
16	16.000	0.375	25.5	12.4	73.9	26.4
400	406.4	9.5	7.8	6.2	22.5	8.0
18	18.000	0.375	28.9	14.1	87.2	31.1
450	457.2	9.5	8.8	7.0	26.6	9.5
20	20.000	0.375	32.2	15.7	97.3	34.8
500	508.0	9.5	9.8	7.8	29.7	10.6
24	24.000	0.375	38.9	19.1	113.0	40.4
600	609.6	9.5	11.9	9.5	34.4	12.3

Fitting Size

Nominal Size	O.D.
In./DN(mm)	In./mm
1	1.315
25	33.4
1 ¼	1.660
32	42.4
1 ½	1.900
40	48.3
2	2.375
50	60.3
2 ½	2.875
65	73.0
3 O.D.	2.996
76.1	76.1
3	3.500
80	88.9
3 ½	4.000
90	101.6
4 ¼ O.D.	4.250
108.0	108.0
4	4.500
100	114.3
5 ¼ O.D.	5.236
133.0	133.0
5 ½ O.D.	5.500
139.7	139.7
5	5.563
140	141.3
6 ¼ O.D.	6.259
159.0	159.0
6 ½ O.D.	6.500
165.1	165.1
6	6.625
150	168.3
8	8.625
200	219.1
10	10.750
250	273.0
12	12.750
300	323.9
14	14.000
350	355.6
16	16.000
400	406.4
18	18.000
450	457.2
20	20.000
500	508.0
24	24.000
600	609.6

Note:

For the reducing tee and branches, use the value that is corresponding to the branch size. For example: for 6" x 6" x 3" tee, the branch value of 3" is 12.8 ft (3.9).

The Fitting Size Chart is used to determine the O.D. of the pipe that the fittings is to be used with. Gruvlok Fittings are identified by either the Nominal size in inches or the Pipe O.D. in/mm.

Reducing Base Support Elbow, Concentric Reducer Fig. 7050RF GR x Flange, 7072GR GR x Flange

Flow Data - Frictional Resistance (Expressed as Equivalent Straight Pipe)

Nominal Size	O.D.	Pipe Wall Thickness	Elbow		Tee	
			90°	45°	Branch	Run
In./DN(mm)	In./mm	In./mm	Ft./m	Ft./m	Ft./m	Ft./m
1	1.315	0.133	1.7	0.9	4.4	1.7
25	33.4	3.4	0.5	0.3	1.3	0.5
1 ¼	1.660	0.140	2.3	1.2	5.8	2.3
32	42.2	3.6	0.7	0.4	1.8	0.7
1 ½	1.900	0.145	2.7	1.3	6.7	2.7
40	48.3	3.7	0.8	0.4	2.0	0.8
2	2.375	0.154	3.4	1.7	8.6	3.4
50	60.3	3.9	1.0	0.5	2.6	1.0
2 ½	2.875	0.203	4.1	2.1	10.3	4.1
65	73.0	5.2	1.2	0.6	3.1	1.2
3 O.D.	2.996	0.197	4.3	2.2	10.8	4.3
76.1	76.1	5.0	1.3	0.7	3.3	1.3
3	3.500	0.216	5.1	2.6	12.8	5.1
80	88.9	5.5	1.6	0.8	3.9	1.6
4 ¼ O.D.	4.250	0.220	6.4	3.2	16.1	6.4
108.0	108.0	5.6	2.0	1.0	4.9	2.0
4	4.500	0.237	6.7	3.4	16.8	6.7
100	114.3	6.0	2.0	1.0	5.1	2.0
5 ¼ O.D.	5.236	0.248	8.0	4.0	20.1	8.0
133.0	133.0	6.3	2.4	1.2	6.1	2.4
5 ½ O.D.	5.500	0.248	8.3	4.2	20.9	8.3
139.7	139.7	6.3	2.5	1.3	6.4	2.5
5	5.563	0.258	8.4	4.2	21.0	8.4
125	141.3	6.6	2.6	1.3	6.4	2.6
6 ¼ O.D.	6.259	0.280	9.7	4.9	24.3	9.7
159.0	159.0	7.1	3.0	1.5	7.4	3.0
6 ½ O.D.	6.500	0.280	10.0	5.0	24.9	10.0
165.1	165.1	7.1	3.0	1.5	7.6	3.0
6	6.625	0.280	10.1	5.1	25.3	10.1
150	168.3	7.1	3.1	1.6	7.7	3.1
8	8.625	0.322	13.3	6.7	33.3	13.3
200	219.1	8.2	4.1	2.0	10.1	4.1
10	10.750	0.365	16.7	8.4	41.8	16.7
250	273.1	9.3	5.1	2.6	12.7	5.1
12	12.750	0.375	20.0	10.0	50.0	20.0
300	323.9	9.5	6.1	3.0	15.2	6.1
14	14.000	0.375	22.2	11.7	64.2	22.9
350	355.6	9.5	6.8	5.4	19.6	7.0
16	16.000	0.375	25.5	12.4	73.9	26.4
400	406.4	9.5	7.8	6.2	22.5	8.0
18	18.000	0.375	28.9	14.5	87.2	31.1
450	457.2	9.5	8.8	7.0	26.6	9.5
20	20.000	0.375	32.2	16.1	97.3	34.8
500	508.0	9.5	9.8	7.8	29.7	10.6
24	24.000	0.375	38.9	19.4	113.0	40.4
600	609.6	9.5	11.9	9.5	34.4	12.3

Note:

For the reducing tee and branches, use the value that is corresponding to the branch size. For example: for 6" x 6" x 3" tee, the branch value of 3" is 12.8 ft (3.9).

The Fitting Size Chart is used to determine the O.D. of the pipe that the fittings is to be used with. Gruvlok Fittings are identified by either the Nominal size in inches or the Pipe O.D. in/mm.

Fitting Size

Nominal Size	O.D.
In./DN(mm)	In./mm
1	1.315
25	33.4
1 ¼	1.660
32	42.4
1 ½	1.900
40	48.3
2	2.375
50	60.3
2 ½	2.875
65	73.0
3 O.D.	2.996
76.1	76.1
3	3.500
80	88.9
3 ½	4.000
90	101.6
4 ¼ O.D.	4.250
108.0	108.0
4	4.500
100	114.3
5 ¼ O.D.	5.236
133.0	133.0
5 ½ O.D.	5.500
139.7	139.7
5	5.563
140	141.3
6 ¼ O.D.	6.259
159.0	159.0
6 ½ O.D.	6.500
165.1	165.1
6	6.625
150	168.3
8	8.625
200	219.1
10	10.750
250	273.0
12	12.750
300	323.9
14	14.000
350	355.6
16	16.000
400	406.4
18	18.000
450	457.2
20	20.000
500	508.0
24	24.000
600	609.6

Fig. 7050RF GR x Flange

Reducing Base Support Elbow – Grooved x 150# Flanged

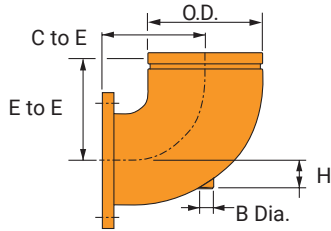

Nominal Size	Grooved End O.D.	Center to End	H	B Dia. Threaded	Approx. Wt. Ea.
In./DN(mm)	In./mm	In./mm	In./mm	NPSC	Lbs./kg
5 x 4 125 x 100	5.563 141.3	12 305	2½ 64	1½ 38	36.5 16.6
6 x 4 150 x 100	6.625 168.3	12 305	2½ 64	1½ 38	38.5 17.5
6 x 5 150 x 125	6.625 168.3	12½ 318	2½ 64	1½ 38	45.4 20.6
8 x 5 200 x 125	8.625 219.1	16 406	3 76	1½ 38	65.5 29.7
8 x 6 200 x 150	8.625 219.1	16 406	3 76	1½ 38	73.0 33.1
10 x 6 250 x 150	10.750 273.1	19 483	3½ 89	1½ 38	100.0 45.4
10 x 8 250 x 200	10.750 273.1	19 483	3½ 89	1½ 38	127.0 57.6
12 x 8 300 x 200	12.750 323.9	22 559	4 102	1½ 38	155.0 70.3
12 x 10 300 x 250	12.750 323.9	22 559	4 102	1½ 38	186.0 84.4

Note:

This product is not UL/ULC Listed or FM Approved.

Fig. 7072GF GR x Flange

Concentric Reducer

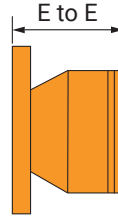

Nominal Size	End to End	Approx. Wt. Ea.
In./DN(mm)	In./mm	Lbs./kg
3 x 2 80 x 65	6½ 165	1.8 0.8
4 x 2 100 x 50	5½ 140	2.5 1.1
4 x 2½ 100 x 65	5¾ 146	2.6 1.2
4 x 3 100 x 80	5¾ 146	2.6 1.2
5 x 3 125 x 80	5 127	4.5 2.0
5 x 4 125 x 100	5½ 140	4.5 2.0
6 x 4 150 x 100	6 152	7.1 3.2
6 x 5 150 x 125	6½ 165	7.4 3.4
8 x 6 200 x 150	7 165	12.6 5.7

Note:

This product is not UL/ULC Listed or FM Approved.

Fig. 7084 Groove x Class 150 Flange Nipple
Fig. 7085 Groove x Class 300 Flange Nipple

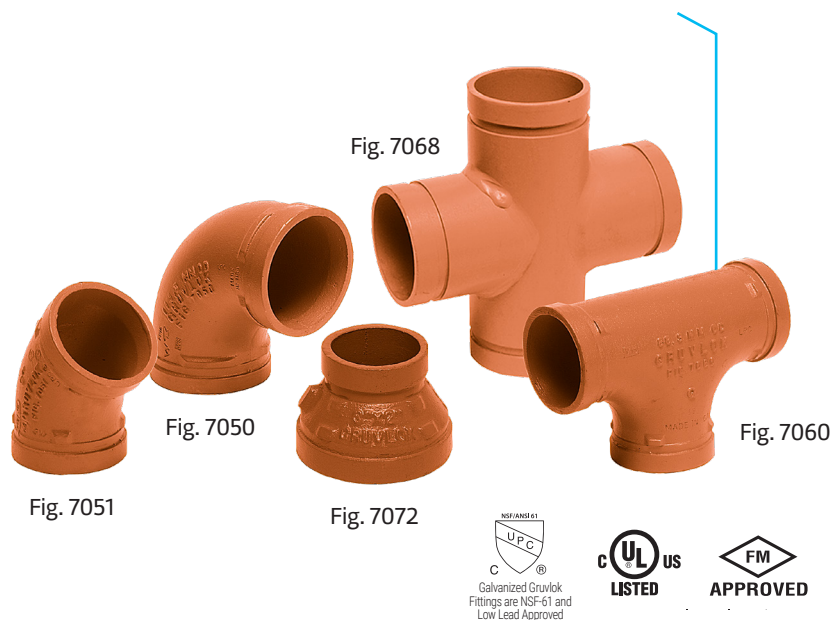

Material Specifications

Cast Fittings

Ductile iron conforming to ASTM A536, Grade 65-45-12
 Malleable iron conforming to ASTM A47

Fabricated Fittings

1-12" Carbon steel, Schedule 40, conforming to ASTM A53, Grade B
 14-24" Carbon steel, 0.375 wall, conforming to ASTM A53, Grade B

Coatings

Rust inhibiting paint
 Color: Orange (standard)
 Hot Dipped Zinc Galvanized conforming to ASTM A153 (optional)
 Other Colors Available (IE: RAL3000 and RAL9000)

Gruvlok fittings are available through 24" nominal pipe size in a variety of styles. Use the Fitting Size Table to convert nominal pipe size to corresponding pipe O.D.

These fittings are designed to provide minimum pressure drop and uniform strength.

Depending on styles and size, Gruvlok fittings are provided in various materials including ductile iron, forged steel or fabricated steel.

Pressure ratings of Gruvlok standard fittings conform to those of Fig. 7001 Gruvlok coupling.

For Listings/Approval Details and Limitations, visit our website at www.asc-es.com or contact an ASC Engineered Solutions™ Sales Representative.

- Introduction
- Couplings
- Outlets
- Fittings**
- Valves & Accessories
- High Pressure
- CTS Copper System
- DI-Electric Nipples
- Plan-End Fittings
- HDPE Couplings
- Socket-It® Fittings
- Stainless Steel Method
- Roll Groovers
- Installation & Assembly
- Special Coatings
- Design Services
- Technical Data
- Master Format 3 Part Specs.
- Pictorial Index

Flange Nipples Fig. 7084, 7085

Flow Data - Frictional Resistance (Expressed as Equivalent Straight Pipe)

Fitting Size

Nominal Size	O.D.	Pipe Wall Thickness	Elbow		Tee	
			90°	45°	Branch	Run
In./DN(mm)	In./mm	In./mm	Ft./m	Ft./m	Ft./m	Ft./m
1	1.315	0.133	1.7	0.9	4.4	1.7
25	33.4	3.4	0.5	0.3	1.3	0.5
1 ¼	1.660	0.140	2.3	1.2	5.8	2.3
32	42.2	3.6	0.7	0.4	1.8	0.7
1 ½	1.900	0.145	2.7	1.3	6.7	2.7
40	48.3	3.7	0.8	0.4	2.0	0.8
2	2.375	0.154	3.4	1.7	8.6	3.4
50	60.3	3.9	1.0	0.5	2.6	1.0
2 ½	2.875	0.203	4.1	2.1	10.3	4.1
65	73.0	5.2	1.2	0.6	3.1	1.2
3 O.D.	2.996	0.197	4.3	2.2	10.8	4.3
76.1	76.1	5.0	1.3	0.7	3.3	1.3
3	3.500	0.216	5.1	2.6	12.8	5.1
80	88.9	5.5	1.6	0.8	3.9	1.6
4 ¼ O.D.	4.250	0.220	6.4	3.2	16.1	6.4
108.0	108.0	5.6	2.0	1.0	4.9	2.0
4	4.500	0.237	6.7	3.4	16.8	6.7
100	114.3	6.0	2.0	1.0	5.1	2.0
5 ¼ O.D.	5.236	0.248	8.0	4.0	20.1	8.0
133.0	133.0	6.3	2.4	1.2	6.1	2.4
5 ½ O.D.	5.500	0.248	8.3	4.2	20.9	8.3
139.7	139.7	6.3	2.5	1.3	6.4	2.5
5	5.563	0.258	8.4	4.2	21.0	8.4
125	141.3	6.6	2.6	1.3	6.4	2.6
6 ¼ O.D.	6.259	0.280	9.7	4.9	24.3	9.7
159.0	159.0	7.1	3.0	1.5	7.4	3.0
6 ½ O.D.	6.500	0.280	10.0	5.0	24.9	10.0
165.1	165.1	7.1	3.0	1.5	7.6	3.0
6	6.625	0.280	10.1	5.1	25.3	10.1
150	168.3	7.1	3.1	1.6	7.7	3.1
8	8.625	0.322	13.3	6.7	33.3	13.3
200	219.1	8.2	4.1	2.0	10.1	4.1
10	10.750	0.365	16.7	8.4	41.8	16.7
250	273.1	9.3	5.1	2.6	12.7	5.1
12	12.750	0.375	20.0	10.0	50.0	20.0
300	323.9	9.5	6.1	3.0	15.2	6.1
14	14.000	0.375	22.2	11.7	64.2	22.9
350	355.6	9.5	6.8	5.4	19.6	7.0
16	16.000	0.375	25.5	12.4	73.9	26.4
400	406.4	9.5	7.8	6.2	22.5	8.0
18	18.000	0.375	28.9	14.1	87.2	31.1
450	457.2	9.5	8.8	7.0	26.6	9.5
20	20.000	0.375	32.2	15.7	97.3	34.8
500	508.0	9.5	9.8	7.8	29.7	10.6
24	24.000	0.375	38.9	19.1	113.0	40.4
600	609.6	9.5	11.9	9.5	34.4	12.3

Nominal Size	O.D.
In./DN(mm)	In./mm
1	1.315
25	33.4
1 ¼	1.660
32	42.4
1 ½	1.900
40	48.3
2	2.375
50	60.3
2 ½	2.875
65	73.0
3 O.D.	2.996
76.1	76.1
3	3.500
80	88.9
3 ½	4.000
90	101.6
4 ¼ O.D.	4.250
108.0	108.0
4	4.500
100	114.3
5 ¼ O.D.	5.236
133.0	133.0
5 ½ O.D.	5.500
139.7	139.7
5	5.563
140	141.3
6 ¼ O.D.	6.259
159.0	159.0
6 ½ O.D.	6.500
165.1	165.1
6	6.625
150	168.3
8	8.625
200	219.1
10	10.750
250	273.0
12	12.750
300	323.9
14	14.000
350	355.6
16	16.000
400	406.4
18	18.000
450	457.2
20	20.000
500	508.0
24	24.000
600	609.6

Note:

For the reducing tee and branches, use the value that is corresponding to the branch size. For example: for 6" x 6" x 3" tee, the branch value of 3" is 12.8 ft (3.9).

The Fitting Size Chart is used to determine the O.D. of the pipe that the fittings is to be used with. Gruvlok Fittings are identified by either the Nominal size in inches or the Pipe O.D. in/mm.

Fig. 7084
Groove x Class 150 Flange Nipple

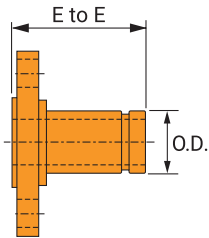

Nominal Size	O.D.	End to End	Approx. Wt. Ea.
In./DN(mm)	In./mm	In./mm	Lbs./kg
1	1.315	3	2.5
25	33.4	76	1.1
1¼	1.660	4	3.8
32	42.2	102	1.7
1½	1.900	4	4.1
40	48.3	102	1.9
2	2.375	4	6.0
50	60.3	102	2.7
2½	2.875	4	9.2
65	73.0	102	4.2
3	3.500	4	10.4
80	88.9	102	4.7
3½	4.000	4	14.0
90	101.6	102	6.4
4	4.500	6	19.1
100	114.3	152	8.7
5	5.563	6	23.0
125	141.3	152	10.4
6	6.625	6	29.5
150	168.3	152	13.4
8	8.625	6	43.5
200	219.1	152	19.7
10	10.750	8	68.2
250	273.1	203	30.9
12	12.750	8	96.1
300	323.9	203	43.6
14	14.000	*	*
350	355.6	*	*
16	16.000	*	*
400	406.4	*	*
18	18.000	*	*
450	457.2	*	*
20	20.000	*	*
500	508.0	*	*
24	24.000	*	*
600	609.6	*	*

Note:

Contact an ASC Engineered Solutions Representative for dimensions & weights.

This product is not UL/ULC Listed or FM Approved.

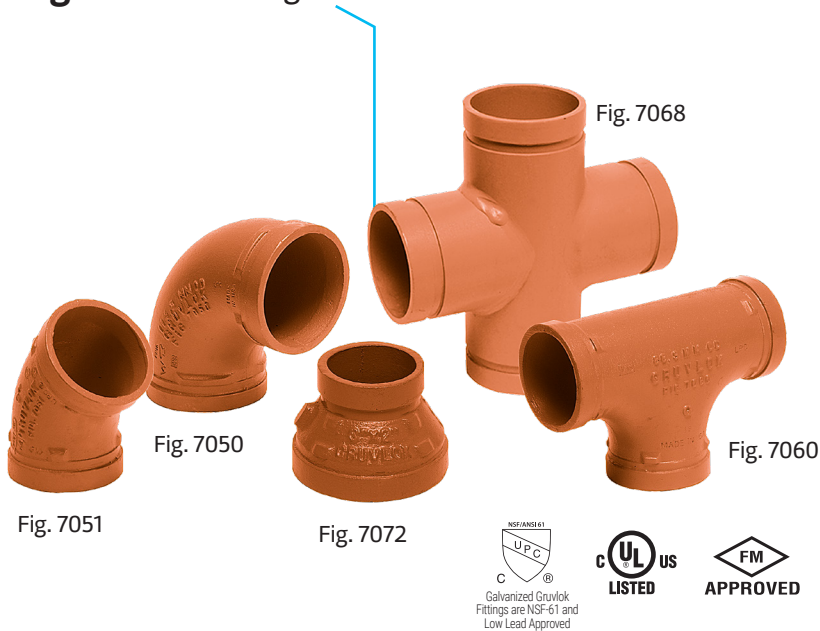

Fig. 7085
Groove x Class 300 Flange Nipple

Nominal Size	Approx. Wt. Ea.
In./DN(mm)	Lbs./kg
3	3.6
76	1.6
4	4.6
102	2.1
4	7.1
102	3.2
4	8.2
102	3.7
4	11.9
102	5.4
4	15.5
102	7.0
4	21.0
102	9.5
6	28.0
152	12.7
6	35.0
152	15.9
6	50.0
152	22.7
6	72.0
152	32.7
8	*
203	*
8	*
203	*
*	*
*	*
*	*
*	*
*	*
*	*
*	*
*	*
*	*
*	*



Fig. 7068 Cross
Fig. 7074 Cap
Fig. 7075 Bull Plug



Material Specifications

Cast Fittings

Ductile iron conforming to ASTM A536, Grade 65-45-12

Malleable iron conforming to ASTM A47

Fabricated Fittings

1-12" Carbon steel, Schedule 40, conforming to ASTM A53, Grade B

14-24" Carbon steel, 0.375 wall, conforming to ASTM A53, Grade B

Coatings

Rust inhibiting paint

Color: Orange (standard)

Hot Dipped Zinc Galvanized conforming to ASTM A153 (optional)

Other Colors Available (IE: RAL3000 and RAL9000)

Gruvlok fittings are available through 24" nominal pipe size in a variety of styles. Use the Fitting Size Table to convert nominal pipe size to corresponding pipe O.D.

These fittings are designed to provide minimum pressure drop and uniform strength.

Depending on styles and size, Gruvlok fittings are provided in various materials including ductile iron, forged steel or fabricated steel.

Pressure ratings of Gruvlok standard fittings conform to those of Fig. 7001 Gruvlok coupling.

For Listings/Approval Details and Limitations, visit our website at www.asc-es.com or contact an ASC Engineered Solutions™ Sales Representative.

Cross, Cap & Bull Plug Fig. 7068, 7074, 7075

Flow Data - Frictional Resistance (Expressed as Equivalent Straight Pipe)

Nominal Size	O.D.	Pipe Wall Thickness	Elbow		Tee	
			90°	45°	Branch	Run
In./DN(mm)	In./mm	In./mm	Ft./m	Ft./m	Ft./m	Ft./m
1	1.315	0.133	1.7	0.9	4.4	1.7
25	33.4	3.4	0.5	0.3	1.3	0.5
1 ¼	1.660	0.140	2.3	1.2	5.8	2.3
32	42.2	3.6	0.7	0.4	1.8	0.7
1 ½	1.900	0.145	2.7	1.3	6.7	2.7
40	48.3	3.7	0.8	0.4	2.0	0.8
2	2.375	0.154	3.4	1.7	8.6	3.4
50	60.3	3.9	1.0	0.5	2.6	1.0
2 ½	2.875	0.203	4.1	2.1	10.3	4.1
65	73.0	5.2	1.2	0.6	3.1	1.2
3 O.D.	2.996	0.197	4.3	2.2	10.8	4.3
76.1	76.1	5.0	1.3	0.7	3.3	1.3
3	3.500	0.216	5.1	2.6	12.8	5.1
80	88.9	5.5	1.6	0.8	3.9	1.6
4 ¼ O.D.	4.250	0.220	6.4	3.2	16.1	6.4
108.0	108.0	5.6	2.0	1.0	4.9	2.0
4	4.500	0.237	6.7	3.4	16.8	6.7
100	114.3	6.0	2.0	1.0	5.1	2.0
5 ¼ O.D.	5.236	0.248	8.0	4.0	20.1	8.0
133.0	133.0	6.3	2.4	1.2	6.1	2.4
5 ½ O.D.	5.500	0.248	8.3	4.2	20.9	8.3
139.7	139.7	6.3	2.5	1.3	6.4	2.5
5	5.563	0.258	8.4	4.2	21.0	8.4
125	141.3	6.6	2.6	1.3	6.4	2.6
6 ¼ O.D.	6.259	0.280	9.7	4.9	24.3	9.7
159.0	159.0	7.1	3.0	1.5	7.4	3.0
6 ½ O.D.	6.500	0.280	10.0	5.0	24.9	10.0
165.1	165.1	7.1	3.0	1.5	7.6	3.0
6	6.625	0.280	10.1	5.1	25.3	10.1
150	168.3	7.1	3.1	1.6	7.7	3.1
8	8.625	0.322	13.3	6.7	33.3	13.3
200	219.1	8.2	4.1	2.0	10.1	4.1
10	10.750	0.365	16.7	8.4	41.8	16.7
250	273.1	9.3	5.1	2.6	12.7	5.1
12	12.750	0.375	20.0	10.0	50.0	20.0
300	323.9	9.5	6.1	3.0	15.2	6.1
14	14.000	0.375	22.2	11.7	64.2	22.9
350	355.6	9.5	6.8	5.4	19.6	7.0
16	16.000	0.375	25.5	12.4	73.9	26.4
400	406.4	9.5	7.8	6.2	22.5	8.0
18	18.000	0.375	28.9	14.1	87.2	31.1
450	457.2	9.5	8.8	7.0	26.6	9.5
20	20.000	0.375	32.2	15.7	97.3	34.8
500	508.0	9.5	9.8	7.8	29.7	10.6
24	24.000	0.375	38.9	19.1	113.0	40.4
600	609.6	9.5	11.9	9.5	34.4	12.3

Note:

For the reducing tee and branches, use the value that is corresponding to the branch size.
For example: for 6" x 6" x 3" tee, the branch value of 3" is 12.8 ft (3.9).

The Fitting Size Chart is used to determine the O.D. of the pipe that the fittings is to be used with.
Gruvlok Fittings are identified by either the Nominal size in inches or the Pipe O.D. in/mm.

Fitting Size

Nominal Size	O.D.
In./DN(mm)	In./mm
1	1.315
25	33.4
1 ¼	1.660
32	42.4
1 ½	1.900
40	48.3
2	2.375
50	60.3
2 ½	2.875
65	73.0
3 O.D.	2.996
76.1	76.1
3	3.500
80	88.9
3 ½	4.000
90	101.6
4 ¼ O.D.	4.250
108.0	108.0
4	4.500
100	114.3
5 ¼ O.D.	5.236
133.0	133.0
5 ½ O.D.	5.500
139.7	139.7
5	5.563
140	141.3
6 ¼ O.D.	6.259
159.0	159.0
6 ½ O.D.	6.500
165.1	165.1
6	6.625
150	168.3
8	8.625
200	219.1
10	10.750
250	273.0
12	12.750
300	323.9
14	14.000
350	355.6
16	16.000
400	406.4
18	18.000
450	457.2
20	20.000
500	508.0
24	24.000
600	609.6

Fig. 7074
Cap

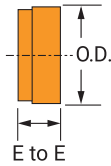
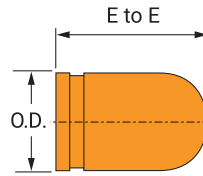

Fig. 7074T: ½", ¾" and 1" tap options available.

Nominal Size	O.D.	End to End	Approx. Wt. Ea.
In./DN(mm)	In./mm	In./mm	Lbs./kg
1C	1.315	1 ¼	0.3
25	33.4	32	0.1
1 ¼ C	1.660	1 ¼	0.4
32	42.2	32	0.2
1 ½ C	1.900	1 ¼	0.5
40	48.3	32	0.2
2 C	2.375	1	0.5
50	60.3	25	0.2
2 ½ C	2.875	1	0.7
65	73.0	25	0.3
3 O.D. C	2.996	1	0.8
76.1	76.1	25	0.4
3 C	3.500	1	1.1
80	88.9	25	0.5
3 ½ C	4.000	1	1.4
90	101.6	25	0.6
4 ¼ O.D. C	4.250	1 ⅝	2.0
108	108.0	29	0.9
4 C	4.500	1 ⅝	2.8
100	114.3	29	1.3
5 ¼ O.D. C	5.236	1 ⅝	3.2
133	133.0	29	1.5
5 ½ O.D. C	5.500	1 ⅝	4.0
139.7	139.7	29	1.8
5 C	5.563	1 ⅝	4.0
125	141.3	29	1.8
6 ¼ O.D. C	6.259	1 ⅝	5.1
159	159.0	29	2.3
6 ½ O.D. C	6.500	1 ⅝	6.0
165.1	165.1	29	2.7
6 C	6.625	1 ⅞	6.0
150	168.3	33	2.7
8 C	8.625	1 ½	12.5
200	219.1	38	5.7
10 C	10.750	1 ½	21.9
250	273.1	38	9.9
12 C	12.750	1 ½	33.8
300	323.9	38	15.3
14*	14.000	8 ½	40.0
350	355.6	216	18.1
16*	16.000	9	45.0
400	406.4	229	20.4
18*	18.000	10	58.0
450	457.2	254	26.3
20*	20.000	11	79.0
500	508.0	279	35.8
24*	24.000	12 ½	100.0
600	609.6	318	45.4

Fig. 7075
Bull Plug



Nominal Size	O.D.	End to End	Approx. Wt. Ea.
In./DN(mm)	In./mm	In./mm	Lbs./kg
2	2.375	4	2.5
50	60.3	102	1.1
2 ½	2.875	5	3.1
65	73.0	127	1.4
3	3.500	6	4.4
80	88.9	152	2.0
4	4.500	7	7.4
100	114.3	178	3.4
5	5.563	9	13.0
125	141.3	22	*
6	6.625	10	18.5
150	168.3	254	8.4

Note:

This product is not UL/ULC Listed or FM Approved.

*Machined Dome Cap
C – Cast Ductile Iron



Fig. 7068
Cross

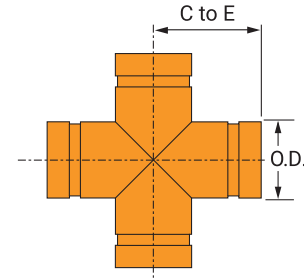

Nominal Size	O.D.	Center to End	Approx. Wt. Ea.
In./DN(mm)	In./mm	In./mm	Lbs./kg
1	1.315	2 ¼	1.3
25	33.4	57	0.6
1 ¼	1.660	2 ¾	2.1
32	42.2	70	1.0
1 ½	1.900	2 ¾	2.5
40	48.3	70	1.1
2	2.375	3 ¼	2.9
50	60.3	83	1.3
2 ½	2.875	3 ¾	5.2
65	73.0	95	2.4
3	3.500	4 ¼	7.5
80	88.9	108	3.4
3 ½	4.000	4 ½	9.8
90	101.6	114	4.4
4	4.500	5	12.2
100	114.3	127	5.5
5	5.563	5 ½	17.6
125	141.3	140	8.0
6	6.625	6 ½	28.3
150	168.3	165	12.8
8	8.625	7 ¾	48.0
200	219.1	197	21.8
10	10.750	9	70.0
250	273.1	229	31.8
12	12.750	10	110.0
300	323.9	254	49.9
14	14.000	11	140.0
350	355.6	279	63.5
16	16.000	12	170.0
400	406.4	305	77.1
18	18.000	15 ½	260.0
450	457.2	394	118.0
20	20.000	17 ¼	320.0
500	508.0	438	145.0
24	24.000	20	585.0
600	609.6	508	265.0

- Fig. 7080** Adapter Nipple (GR x GR)
- Fig. 7081** Adapter Nipple (GR x MPT)
- Fig. 7082** Adapter Nipple (GR x BEV)
- Fig. 7086** Hose Nipple (GR x HOSE)



Material Specifications

Cast Fittings

Ductile iron conforming to ASTM A536, Grade 65-45-12

Malleable iron conforming to ASTM A47

Fabricated Fittings

1-12" Carbon steel, Schedule 40, conforming to ASTM A53, Grade B

14-24" Carbon steel, 0.375 wall, conforming to ASTM A53, Grade B

Coatings

Rust inhibiting paint
Color: Orange (standard)

Hot Dipped Zinc Galvanized conforming to ASTM A153 (optional)

Other Colors Available
(IE: RAL3000 and RAL9000)

Gruvlok fittings are available through 24" nominal pipe size in a variety of styles. Use the Fitting Size Table to convert nominal pipe size to corresponding pipe O.D.

These fittings are designed to provide minimum pressure drop and uniform strength.

Depending on styles and size, Gruvlok fittings are provided in various materials including ductile iron, forged steel or fabricated steel.

Pressure ratings of Gruvlok standard fittings conform to those of Fig. 7001 Gruvlok coupling.

For Listings/Approval Details and Limitations, visit our website at www.asc-es.com or contact an ASC Engineered Solutions™ Sales Representative.

- Introduction
- Couplings
- Outlets
- Fittings**
- Valves & Accessories
- High Pressure
- CTS Copper System
- DI-Electric Nipples
- Plan-End Fittings
- HDPE Couplings
- Sock-It® Fittings
- Stainless Steel Method
- Roll Groovers
- Installation & Assembly
- Special Coatings
- Design Services
- Technical Data
- Master Format 3 Part Specs.
- Pictorial Index

Adapter Nipples & Hose Nipple Fig. 7080, 7081, 7082, 7086

Flow Data - Frictional Resistance (Expressed as Equivalent Straight Pipe)

Nominal Size	O.D.	Pipe Wall Thickness	Elbow		Tee	
			90°	45°	Branch	Run
In./DN(mm)	In./mm	In./mm	Ft./m	Ft./m	Ft./m	Ft./m
1	1.315	0.133	1.7	0.9	4.4	1.7
25	33.4	3.4	0.5	0.3	1.3	0.5
1 ¼	1.660	0.140	2.3	1.2	5.8	2.3
32	42.2	3.6	0.7	0.4	1.8	0.7
1 ½	1.900	0.145	2.7	1.3	6.7	2.7
40	48.3	3.7	0.8	0.4	2.0	0.8
2	2.375	0.154	3.4	1.7	8.6	3.4
50	60.3	3.9	1.0	0.5	2.6	1.0
2 ½	2.875	0.203	4.1	2.1	10.3	4.1
65	73.0	5.2	1.2	0.6	3.1	1.2
3 O.D.	2.996	0.197	4.3	2.2	10.8	4.3
76.1	76.1	5.0	1.3	0.7	3.3	1.3
3	3.500	0.216	5.1	2.6	12.8	5.1
80	88.9	5.5	1.6	0.8	3.9	1.6
4 ¼ O.D.	4.250	0.220	6.4	3.2	16.1	6.4
108.0	108.0	5.6	2.0	1.0	4.9	2.0
4	4.500	0.237	6.7	3.4	16.8	6.7
100	114.3	6.0	2.0	1.0	5.1	2.0
5 ¼ O.D.	5.236	0.248	8.0	4.0	20.1	8.0
133.0	133.0	6.3	2.4	1.2	6.1	2.4
5 ½ O.D.	5.500	0.248	8.3	4.2	20.9	8.3
139.7	139.7	6.3	2.5	1.3	6.4	2.5
5	5.563	0.258	8.4	4.2	21.0	8.4
125	141.3	6.6	2.6	1.3	6.4	2.6
6 ¼ O.D.	6.259	0.280	9.7	4.9	24.3	9.7
159.0	159.0	7.1	3.0	1.5	7.4	3.0
6 ½ O.D.	6.500	0.280	10.0	5.0	24.9	10.0
165.1	165.1	7.1	3.0	1.5	7.6	3.0
6	6.625	0.280	10.1	5.1	25.3	10.1
150	168.3	7.1	3.1	1.6	7.7	3.1
8	8.625	0.322	13.3	6.7	33.3	13.3
200	219.1	8.2	4.1	2.0	10.1	4.1
10	10.750	0.365	16.7	8.4	41.8	16.7
250	273.1	9.3	5.1	2.6	12.7	5.1
12	12.750	0.375	20.0	10.0	50.0	20.0
300	323.9	9.5	6.1	3.0	15.2	6.1
14	14.000	0.375	22.2	11.7	64.2	22.9
350	355.6	9.5	6.8	3.4	19.6	7.0
16	16.000	0.375	25.5	12.8	73.9	26.4
400	406.4	9.5	7.8	3.9	22.5	8.0
18	18.000	0.375	28.9	14.5	87.2	31.1
450	457.2	9.5	8.8	4.4	26.6	9.5
20	20.000	0.375	32.2	16.1	97.3	34.8
500	508.0	9.5	9.8	4.9	29.7	10.6
24	24.000	0.375	38.9	19.4	113.0	40.4
600	609.6	9.5	11.9	5.9	34.4	12.3

Note:

For the reducing tee and branches, use the value that is corresponding to the branch size.
For example: for 6" x 6" x 3" tee, the branch value of 3" is 12.8 ft (3.9).

The Fitting Size Chart is used to determine the O.D. of the pipe that the fittings is to be used with. Gruvlok Fittings are identified by either the Nominal size in inches or the Pipe O.D. in/mm.

Fitting Size

Nominal Size	O.D.
In./DN(mm)	In./mm
1	1.315
25	33.4
1 ¼	1.660
32	42.4
1 ½	1.900
40	48.3
2	2.375
50	60.3
2 ½	2.875
65	73.0
3 O.D.	2.996
76.1	76.1
3	3.500
80	88.9
3 ½	4.000
90	101.6
4 ¼ O.D.	4.250
108.0	108.0
4	4.500
100	114.3
5 ¼ O.D.	5.236
133.0	133.0
5 ½ O.D.	5.500
139.7	139.7
5	5.563
140	141.3
6 ¼ O.D.	6.259
159.0	159.0
6 ½ O.D.	6.500
165.1	165.1
6	6.625
150	168.3
8	8.625
200	219.1
10	10.750
250	273.0
12	12.750
300	323.9
14	14.000
350	355.6
16	16.000
400	406.4
18	18.000
450	457.2
20	20.000
500	508.0
24	24.000
600	609.6

Fig. 7086
Swaged Nipple (GR x GR)

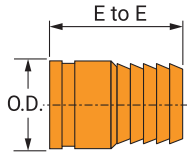

Nominal Size	O.D.	End to End	Approx. Wt. Ea.
In./DN(mm)	In./mm	In./mm	Lbs./kg
1	1.315	3 1/4	0.4
25	33.4	83	0.2
1 1/4	1.660	3 5/8	0.7
32	42.2	92	0.3
1 1/2	1.900	4	0.8
40	48.3	102	0.4
2	2.375	4 5/8	1.3
50	60.3	117	0.6
2 1/2	2.875	5 1/2	2.1
65	73.0	140	1.0
3	3.500	6	3.3
80	88.9	152	1.5
4	4.500	7 1/4	5.5
100	114.3	184	2.5
5	5.563	9 3/4	8.1
125	141.3	248	3.7
6	6.625	11	13.2
150	168.3	279	6.0
8	8.625	12 1/2	24.0
200	219.1	318	10.9
10	10.750	14	29.0
250	273.1	356	13.2
12	12.750	16	46.0
300	323.9	406	20.9

Note:
This product is not UL/ULC Listed or FM Approved.

Fig. 7080
Adapter Nipple (GR x GR)

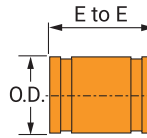

Fig. 7081
Adapter Nipple (GR x MPT)

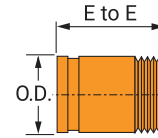
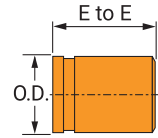

Fig. 7082
Adapter Nipple (GR x BEV)



Nominal Size	O.D.	Length
In./DN(mm)	In./mm	In.
3/4	1.050	
20	26.7	
1	1.315	
25	33.4	
1 1/4	1.660	
32	42.2	
1 1/2	1.900	
40	48.3	
2	2.375	
50	60.3	
2 1/2	2.875	
65	73.0	
3	3.500	
80	88.9	
4	4.500	
100	114.3	
5	5.563	
125	141.3	
6	6.625	
150	168.3	
8	8.625	
200	219.1	
10	10.750	
250	273.1	
12	12.750	
300	323.9	

Multiple Lengths Available:
4", 6", 8", 10" and 12"

Note:
This product is not ULC Listed.

For Listings/Approval Details and Limitations, visit our website at www.asc-es.com or contact an ASC Engineered Solutions™ Sales Representative.

- Fig. 7050DR** 90° Drain Elbow
- Fig. 7062** Bullhead Tee (GR x GR x FPT)
- Fig. 7065** Standpipe Tee (GR x GR x FPT)

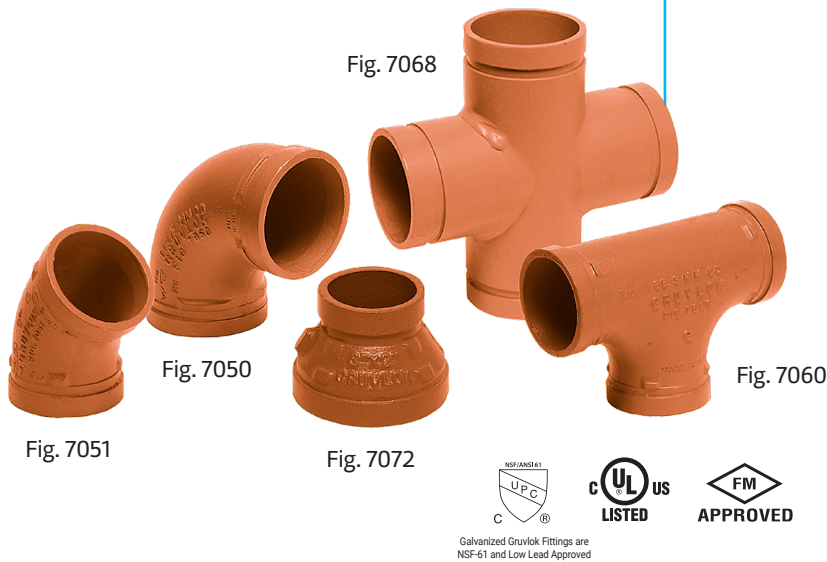

Material Specifications

Cast Fittings

Ductile iron conforming to ASTM A536, Grade 65-45-12

Malleable iron conforming to ASTM A47

Fabricated Fittings

1-12" Carbon steel, Schedule 40, conforming to ASTM A53, Grade B

14-24" Carbon steel, 0.375 wall, conforming to ASTM A53, Grade B

Coatings

Rust inhibiting paint
Color: Orange (standard)

Hot Dipped Zinc Galvanized conforming to ASTM A153 (optional)

Other Colors Available
(IE: RAL3000 and RAL9000)

Gruvlok fittings are available through 24" nominal pipe size in a variety of styles. Use the Fitting Size Table to convert nominal pipe size to corresponding pipe O.D.

These fittings are designed to provide minimum pressure drop and uniform strength.

Depending on styles and size, Gruvlok fittings are provided in various materials including ductile iron, forged steel or fabricated steel.

Pressure ratings of Gruvlok standard fittings conform to those of Fig. 7001 Gruvlok coupling.

For Listings/Approval Details and Limitations, visit our website at www.asc-es.com or contact an ASC Engineered Solutions™ Sales Representative.

Drain Elbow, Bullhead Tee & Standard Tee Fig. 7050DR, 7062, 7065

Flow Data - Frictional Resistance (Expressed as Equivalent Straight Pipe)

Nominal Size	O.D.	Pipe Wall Thickness	Elbow		Tee	
			90°	45°	Branch	Run
In./DN(mm)	In./mm	In./mm	Ft./m	Ft./m	Ft./m	Ft./m
1	1.315	0.133	1.7	0.9	4.4	1.7
25	33.4	3.4	0.5	0.3	1.3	0.5
1 ¼	1.660	0.140	2.3	1.2	5.8	2.3
32	42.2	3.6	0.7	0.4	1.8	0.7
1 ½	1.900	0.145	2.7	1.3	6.7	2.7
40	48.3	3.7	0.8	0.4	2.0	0.8
2	2.375	0.154	3.4	1.7	8.6	3.4
50	60.3	3.9	1.0	0.5	2.6	1.0
2 ½	2.875	0.203	4.1	2.1	10.3	4.1
65	73.0	5.2	1.2	0.6	3.1	1.2
3 O.D.	2.996	0.197	4.3	2.2	10.8	4.3
76.1	76.1	5.0	1.3	0.7	3.3	1.3
3	3.500	0.216	5.1	2.6	12.8	5.1
80	88.9	5.5	1.6	0.8	3.9	1.6
4 ¼ O.D.	4.250	0.220	6.4	3.2	16.1	6.4
108.0	108.0	5.6	2.0	1.0	4.9	2.0
4	4.500	0.237	6.7	3.4	16.8	6.7
100	114.3	6.0	2.0	1.0	5.1	2.0
5 ¼ O.D.	5.236	0.248	8.0	4.0	20.1	8.0
133.0	133.0	6.3	2.4	1.2	6.1	2.4
5 ½ O.D.	5.500	0.248	8.3	4.2	20.9	8.3
139.7	139.7	6.3	2.5	1.3	6.4	2.5
5	5.563	0.258	8.4	4.2	21.0	8.4
125	141.3	6.6	2.6	1.3	6.4	2.6
6 ¼ O.D.	6.259	0.280	9.7	4.9	24.3	9.7
159.0	159.0	7.1	3.0	1.5	7.4	3.0
6 ½ O.D.	6.500	0.280	10.0	5.0	24.9	10.0
165.1	165.1	7.1	3.0	1.5	7.6	3.0
6	6.625	0.280	10.1	5.1	25.3	10.1
150	168.3	7.1	3.1	1.6	7.7	3.1
8	8.625	0.322	13.3	6.7	33.3	13.3
200	219.1	8.2	4.1	2.0	10.1	4.1
10	10.750	0.365	16.7	8.4	41.8	16.7
250	273.1	9.3	5.1	2.6	12.7	5.1
12	12.750	0.375	20.0	10.0	50.0	20.0
300	323.9	9.5	6.1	3.0	15.2	6.1
14	14.000	0.375	22.2	11.7	64.2	22.9
350	355.6	9.5	6.8	3.4	19.6	7.0
16	16.000	0.375	25.5	12.4	73.9	26.4
400	406.4	9.5	7.8	3.9	22.5	8.0
18	18.000	0.375	28.9	14.1	87.2	31.1
450	457.2	9.5	8.8	4.4	26.6	9.5
20	20.000	0.375	32.2	15.7	97.3	34.8
500	508.0	9.5	9.8	4.9	29.7	10.6
24	24.000	0.375	38.9	19.1	113.0	40.4
600	609.6	9.5	11.9	5.9	34.4	12.3

Note:

For the reducing tee and branches, use the value that is corresponding to the branch size. For example: for 6" x 6" x 3" tee, the branch value of 3" is 12.8 ft (3.9).

The Fitting Size Chart is used to determine the O.D. of the pipe that the fittings is to be used with. Gruvlok Fittings are identified by either the Nominal size in inches or the Pipe O.D. in/mm.

Fitting Size

Nominal Size	O.D.
In./DN(mm)	In./mm
1	1.315
25	33.4
1 ¼	1.660
32	42.4
1 ½	1.900
40	48.3
2	2.375
50	60.3
2 ½	2.875
65	73.0
3 O.D.	2.996
76.1	76.1
3	3.500
80	88.9
3 ½	4.000
90	101.6
4 ¼ O.D.	4.250
108.0	108.0
4	4.500
100	114.3
5 ¼ O.D.	5.236
133.0	133.0
5 ½ O.D.	5.500
139.7	139.7
5	5.563
140	141.3
6 ¼ O.D.	6.259
159.0	159.0
6 ½ O.D.	6.500
165.1	165.1
6	6.625
150	168.3
8	8.625
200	219.1
10	10.750
250	273.0
12	12.750
300	323.9
14	14.000
250	355.6
16	16.000
400	406.4
18	18.000
450	457.2
20	20.000
500	508.0
24	24.000
600	609.6

Fig. 7050DR
90° Drain Elbow

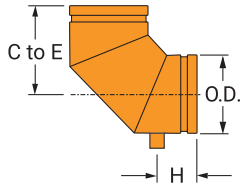

Nominal Size	O.D.	Max Working Pressure	Dimensions		Approx. Wt. Ea.
			C to E	H	
In./DN(mm)	In./mm	PSI/bar	In./mm	In./mm	Lbs./kg
1¼	1.660	300	2¾	1¾	0.7
32	42.2	20.7	69	44	0.3
1½	1.900	300	2¾	1¾	1.7
40	48.3	20.7	69	44	0.8
2	2.375	300	3¼	1¾	2.0
50	60.3	20.7	83	44	0.9
2½	2.875	300	3¾	1⅞	2.5
65	73.0	20.7	95	48	1.1
3	3.500	300	4¼	2	3.2
80	88.9	20.7	108	51	1.5
4	4.500	300	5	2¼	4.6
100	114.3	20.7	127	57	2.1
5	5.583	300	5½	2⅝	11.5
125	141.3	20.7	140	60	5.2
6	6.625	300	6½	2⅞	9.6
150	168.3	20.7	165	60	4.4
8	8.625	300	7¾	2½	15.8
200	219.1	20.7	197	64	7.2
10	10.750	300	9	2¾	48.5
250	273.1	20.7	229	69	22.0
12	12.750	300	10	2¾	66.0
300	323.9	20.7	254	69	29.0

Note:
Available fabricated Schedule 10/40.
Drain elbow has a standard 1" female NPT outlet.

Fig. 7062
Bullhead Tee
(GR x GR x FPT)

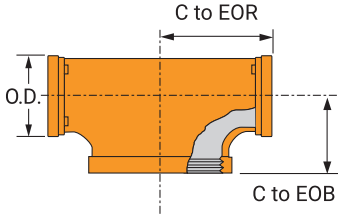

Nominal Size	Center to End of Run	Center to End of Branch	Approx. Wt. Ea.
5 x 5 x 8	7¾	5½	31.0
125 x 125 x 200	197	140	14.1
6 x 6 x 8	7¾	6½	37.6
150 x 150 x 200	197	165	17.1

Note:
See Fitting Size chart on next page for O.D.
These fittings are designed to provide minimal pressure drop and uniform strength.
Pressure ratings of Gruvlok Fittings conforms to those of Fig. 7001 Gruvlok Standard Coupling.

Fig. 7065
Standpipe Tee
(GR x GR x FPT)

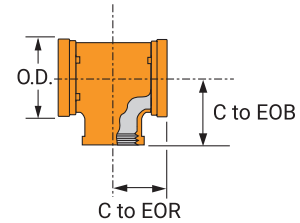

Nominal Size	O.D.	Center to End of Run	Center to End of Branch	Approx. Wt. Ea.
4 x 4 x 2½	4.500	3¼	4	7.6
100 x 100 x 65	114.3	83	102	3.4
6 x 6 x 2½	6.625	3¼	5⅞	11.2
150 x 150 x 65	168.3	83	130	5.1



 For Listings/Approval Details and Limitations, visit our website at www.asc-es.com or contact an ASC Engineered Solutions™ Sales Representative.

90° Short Pattern Elbow Fig. 7450



Material Specifications

Cast Fittings

Ductile iron conforming to ASTM A536, Grade 65-45-12

Malleable iron conforming to ASTM A47

Fabricated Fittings

1-12" Carbon steel, Schedule 40, conforming to ASTM A53, Grade B

14-24" Carbon steel, 0.375 wall, conforming to ASTM A53, Grade B

Coatings

Rust inhibiting paint
Color: Orange (standard)

Hot Dipped Zinc Galvanized conforming to ASTM A153 (optional)

Other Colors Available
(IE: RAL3000 and RAL9000)

Gruvlok fittings are available through 24" nominal pipe size in a variety of styles. Use the Fitting Size Table to convert nominal pipe size to corresponding pipe O.D.

These fittings are designed to provide minimum pressure drop and uniform strength.

Depending on styles and size, Gruvlok fittings are provided in various materials including ductile iron, forged steel or fabricated steel.

Pressure ratings of Gruvlok standard fittings conform to those of Fig. 7001 Gruvlok coupling.

For Listings/Approval Details and Limitations, visit our website at www.asc-es.com or contact an ASC Engineered Solutions™ Sales Representative.

- Introduction
- Couplings
- Outlets
- Fittings**
- Valves & Accessories
- High Pressure
- CTS Copper System
- DI-Electric Nipples
- Plan-End Fittings
- HDPE Couplings
- Socket-It Fittings
- Stainless Steel Method
- Roll Groovers
- Installation & Assembly
- Special Coatings
- Design Services
- Technical Data
- Master Format 3 Part Specs.
- Pictorial Index

90° Short Pattern Elbow Fig. 7450

Flow Data - Frictional Resistance (Expressed as Equivalent Straight Pipe)

Nominal Size	O.D.	Pipe Wall Thickness	Elbow		Tee	
			90°	45°	Branch	Run
In./DN(mm)	In./mm	In./mm	Ft./m	Ft./m	Ft./m	Ft./m
1	1.315	0.133	1.7	0.9	4.4	1.7
25	33.4	3.4	0.5	0.3	1.3	0.5
1 ¼	1.660	0.140	2.3	1.2	5.8	2.3
32	42.2	3.6	0.7	0.4	1.8	0.7
1 ½	1.900	0.145	2.7	1.3	6.7	2.7
40	48.3	3.7	0.8	0.4	2.0	0.8
2	2.375	0.154	3.4	1.7	8.6	3.4
50	60.3	3.9	1.0	0.5	2.6	1.0
2 ½	2.875	0.203	4.1	2.1	10.3	4.1
65	73.0	5.2	1.2	0.6	3.1	1.2
3 O.D.	2.996	0.197	4.3	2.2	10.8	4.3
76.1	76.1	5.0	1.3	0.7	3.3	1.3
3	3.500	0.216	5.1	2.6	12.8	5.1
80	88.9	5.5	1.6	0.8	3.9	1.6
4 ¼ O.D.	4.250	0.220	6.4	3.2	16.1	6.4
108.0	108.0	5.6	2.0	1.0	4.9	2.0
4	4.500	0.237	6.7	3.4	16.8	6.7
100	114.3	6.0	2.0	1.0	5.1	2.0
5 ¼ O.D.	5.236	0.248	8.0	4.0	20.1	8.0
133.0	133.0	6.3	2.4	1.2	6.1	2.4
5 ½ O.D.	5.500	0.248	8.3	4.2	20.9	8.3
139.7	139.7	6.3	2.5	1.3	6.4	2.5
5	5.563	0.258	8.4	4.2	21.0	8.4
125	141.3	6.6	2.6	1.3	6.4	2.6
6 ¼ O.D.	6.259	0.280	9.7	4.9	24.3	9.7
159.0	159.0	7.1	3.0	1.5	7.4	3.0
6 ½ O.D.	6.500	0.280	10.0	5.0	24.9	10.0
165.1	165.1	7.1	3.0	1.5	7.6	3.0
6	6.625	0.280	10.1	5.1	25.3	10.1
150	168.3	7.1	3.1	1.6	7.7	3.1
8	8.625	0.322	13.3	6.7	33.3	13.3
200	219.1	8.2	4.1	2.0	10.1	4.1
10	10.750	0.365	16.7	8.4	41.8	16.7
250	273.1	9.3	5.1	2.6	12.7	5.1
12	12.750	0.375	20.0	10.0	50.0	20.0
300	323.9	9.5	6.1	3.0	15.2	6.1
14	14.000	0.375	22.2	11.1	55.6	22.2
350	355.6	9.5	6.8	3.4	16.6	6.8
16	16.000	0.375	25.5	12.8	64.0	25.5
400	406.4	9.5	7.8	3.9	18.3	7.8
18	18.000	0.375	28.9	14.5	72.0	28.9
450	457.2	9.5	8.8	4.4	20.3	8.8
20	20.000	0.375	32.2	16.1	80.0	32.2
500	508.0	9.5	9.8	4.9	22.3	9.8
24	24.000	0.375	38.9	19.5	97.3	38.9
600	609.6	9.5	11.9	5.9	26.3	11.9

Note:

For the reducing tee and branches, use the value that is corresponding to the branch size.
For example: for 6" x 6" x 3" tee, the branch value of 3" is 12.8 ft (3.9).

The Fitting Size Chart is used to determine the O.D. of the pipe that the fittings is to be used with. Gruvlok Fittings are identified by either the Nominal size in inches or the Pipe O.D. in/mm.

Fitting Size

Nominal Size	O.D.
In./DN(mm)	In./mm
1	1.315
25	33.4
1 ¼	1.660
32	42.4
1 ½	1.900
40	48.3
2	2.375
50	60.3
2 ½	2.875
65	73.0
3 O.D.	2.996
76.1	76.1
3	3.500
80	88.9
3 ½	4.000
90	101.6
4 ¼ O.D.	4.250
108.0	108.0
4	4.500
100	114.3
5 ¼ O.D.	5.236
133.0	133.0
5 ½ O.D.	5.500
139.7	139.7
5	5.563
140	141.3
6 ¼ O.D.	6.259
159.0	159.0
6 ½ O.D.	6.500
165.1	165.1
6	6.625
150	168.3
8	8.625
200	219.1
10	10.750
250	273.0
12	12.750
300	323.9
14	14.000
350	355.6
16	16.000
400	406.4
18	18.000
450	457.2
20	20.000
500	508.0
24	24.000
600	609.6

FIRE-RITE® 90° Short Pattern Elbow Fig. 7450

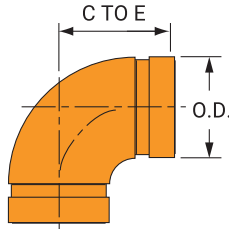

The Gruvlok Fire-Rite short pattern 90° elbows has a 2" to 8" size range and a 300 psi pressure rating

Fire-Rite fittings are painted to industry specification and are available galvanized for more corrosive environments.

CAD design increases internal diameters and provides superior flow capability.

Figure 7450 90° Elbow Short Pattern Fitting – Pressure Drop

Nominal Size	O.D.	Center to End	Approx. Wt. Ea.
In./DN(mm)	In./mm	In./mm	Lbs./kg
2	2.375	2¾	1.7
50	60.3	70	0.8
2½	2.875	3	2.6
65	73.0	76	1.2
3	3.500	3¾	3.5
80	88.9	86	1.6
4	4.500	4	6.5
100	114.3	102	3.0
6	6.625	5½	14.8
150	168.3	140	6.7
8	8.625	6¾	25.6
200	219.1	175	11.6

Note:
All are Ductile Iron.

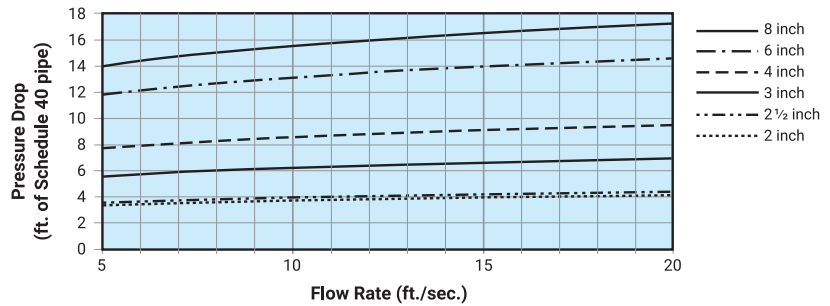

Note:
Gruvlok short pattern fittings exceed the headloss requirements of NFPA 13.
For Fig. 7450 90° grooved end elbows use the value shown.
Above values are shown for Schedule 40 pipe to be consistent with industry practices.



For Listings/Approval Details and Limitations, visit our website at www.asc-es.com or contact an ASC Engineered Solutions™ Sales Representative.

Fire-Rite® Short Pattern Tee Fig. 7460*

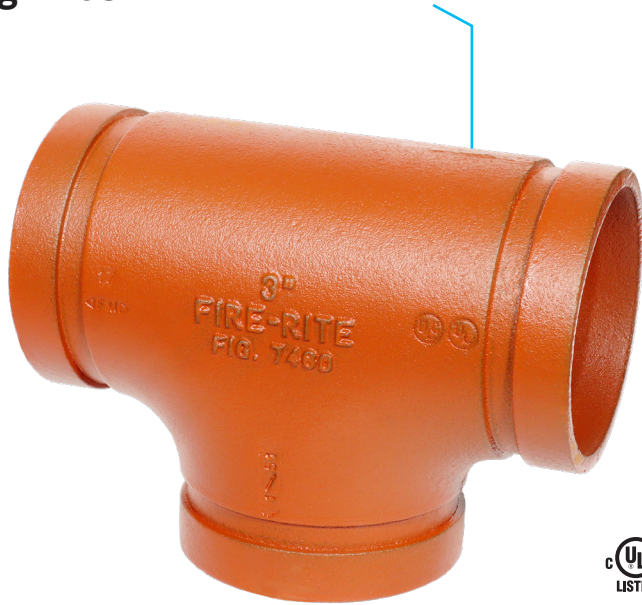

 - Available galvanized

Material Specifications

Fabricated Fittings

Ductile Iron conforming to ASTM A536

Coatings

Rust inhibiting paint

Color: Orange (Standard)

Hot Dipped Zinc Galvanized conforming to ASTM A153 (Optional)

Other available options (Example: RAL3000 or RAL9000 Series)

The Gruvlok® Fire-Rite® short pattern fitting system incorporates 90° elbows and tees in 2" to 8" size range with a 300 psi pressure rating.

Fire-Rite fittings are painted to industry specification and are available galvanized for more corrosive environments.

CAD design increases internal diameters and provides superior flow capability.

Fire-Rite fittings are cast from ASTM A536 Ductile Iron to Grade 65-45-12.

Fire-Rite – Light Weight – Heavy Value!

For Listings/Approval Details and Limitations, visit our website at www.asc-es.com or contact an ASC Engineered Solutions™ Sales Representative

*When ordering, refer to product as FP7460.

Fire-Rite® Short Pattern Tee Fig. 7460*

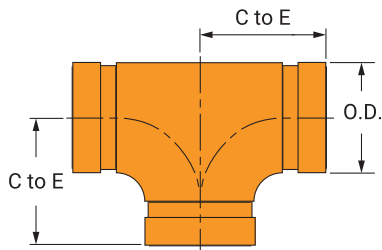

Nominal Size	O.D.	Center to End	Approx. Wt. Ea.
In./DN(mm)	In./mm	In./mm	Lbs./kg
2	2.375	2¾	2.5
50	60.3	70	1.1
2½	2.875	3	3.5
65	73.0	76	1.6
3	3.500	3¾	4.8
80	88.9	86	2.2
4	4.500	4	8.1
100	114.3	102	3.7
6	6.625	5½	19.1
150	168.3	140	8.7
8	8.625	6¾	35.2
200	219.1	175	16.0

Note:

Additional sizes available, see Gruvlok Catalog or contact an ASC Engineered Solutions Representative.

Fig. 7460 Tee Short Pattern Fitting - Pressure Drop

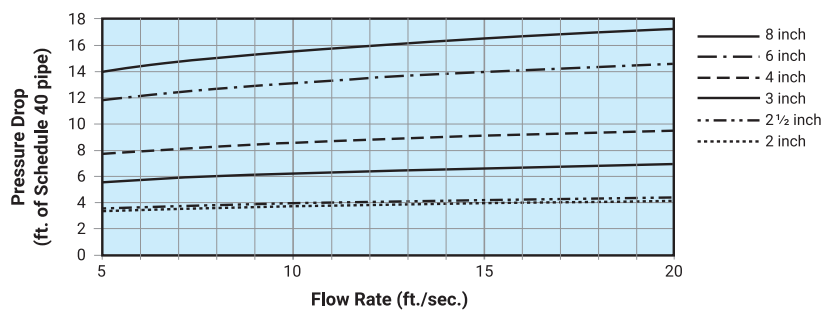

Note:

Gruvlok short pattern fittings exceed the headloss requirements of NFPA 13.

For Fig. 7460 Tee branch use 2½ times the value shown.

For Fig. 7460 Tee run use the value shown.

Note: Above values are shown for Schedule 40 pipe to be consistent with industry practices.

Fig. 7050-3D 90° Elbow
Fig. 7057-3D 60° Elbow
Fig. 7051-3D 45° Elbow
Fig. 7058-3D 30° Elbow

Fig. 7052-3D 22½° Elbow
Fig. 7053-3D 11¼° Elbow

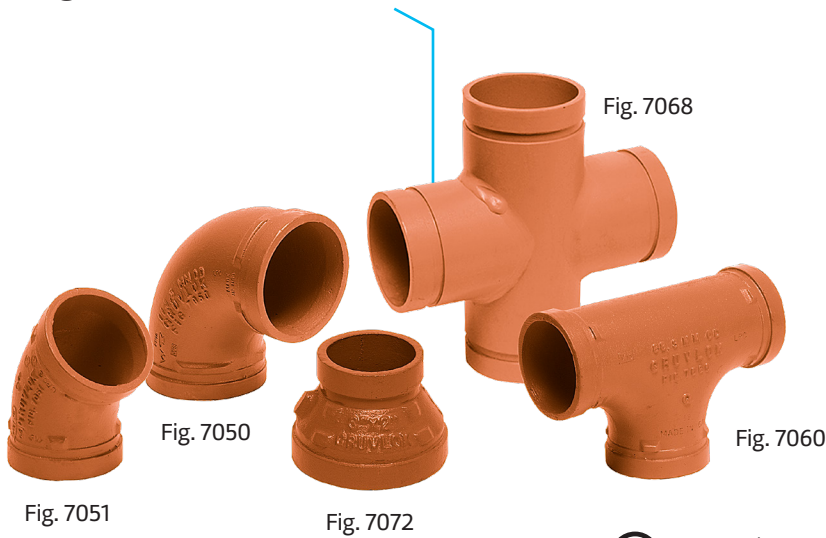

Material Specifications

Cast Fittings

Ductile iron conforming to ASTM A536, Grade 65-45-12

Malleable iron conforming to ASTM A47

Fabricated Fittings

1-12" Carbon steel, Schedule 40, conforming to ASTM A53, Grade B

14-24" Carbon steel, 0.375 wall, conforming to ASTM A53, Grade B

Coatings

Rust inhibiting paint

Color: Orange (standard)

Hot Dipped Zinc Galvanized conforming to ASTM A153 (optional)

Other Colors Available
 (IE: RAL3000 and RAL9000)



Galvanized Gruvlok Fittings are NSF-61 and Low Lead Approved

Gruvlok fittings are available through 24" nominal pipe size in a variety of styles. Use the Fitting Size Table to convert nominal pipe size to corresponding pipe O.D.

These fittings are designed to provide minimum pressure drop and uniform strength.

Depending on styles and size, Gruvlok fittings are provided in various materials including ductile iron, forged steel or fabricated steel.

Pressure ratings of Gruvlok standard fittings conform to those of Fig. 7001 Gruvlok coupling.

For Listings/Approval Details and Limitations, visit our website at www.asc-es.com or contact an ASC Engineered Solutions™ Sales Representative.

Long Radius Elbows

Fig. 7050-3D, 7057-3D, 7051-3D, 7058-3D, 7052-3D, 7053-3D

Flow Data - Frictional Resistance (Expressed as Equivalent Straight Pipe)

Nominal Size	O.D.	Pipe Wall Thickness	Elbow		Tee	
			90°	45°	Branch	Run
In./DN(mm)	In./mm	In./mm	Ft./m	Ft./m	Ft./m	Ft./m
1	1.315	0.133	1.7	0.9	4.4	1.7
25	33.4	3.4	0.5	0.3	1.3	0.5
1 1/4	1.660	0.140	2.3	1.2	5.8	2.3
32	42.2	3.6	0.7	0.4	1.8	0.7
1 1/2	1.900	0.145	2.7	1.3	6.7	2.7
40	48.3	3.7	0.8	0.4	2.0	0.8
2	2.375	0.154	3.4	1.7	8.6	3.4
50	60.3	3.9	1.0	0.5	2.6	1.0
2 1/2	2.875	0.203	4.1	2.1	10.3	4.1
65	73.0	5.2	1.2	0.6	3.1	1.2
3 O.D.	2.996	0.197	4.3	2.2	10.8	4.3
76.1	76.1	5.0	1.3	0.7	3.3	1.3
3	3.500	0.216	5.1	2.6	12.8	5.1
80	88.9	5.5	1.6	0.8	3.9	1.6
4 1/4 O.D.	4.250	0.220	6.4	3.2	16.1	6.4
108.0	108.0	5.6	2.0	1.0	4.9	2.0
4	4.500	0.237	6.7	3.4	16.8	6.7
100	114.3	6.0	2.0	1.0	5.1	2.0
5 1/4 O.D.	5.236	0.248	8.0	4.0	20.1	8.0
133.0	133.0	6.3	2.4	1.2	6.1	2.4
5 1/2 O.D.	5.500	0.248	8.3	4.2	20.9	8.3
139.7	139.7	6.3	2.5	1.3	6.4	2.5
5	5.563	0.258	8.4	4.2	21.0	8.4
125	141.3	6.6	2.6	1.3	6.4	2.6
6 1/4 O.D.	6.259	0.280	9.7	4.9	24.3	9.7
159.0	159.0	7.1	3.0	1.5	7.4	3.0
6 1/2 O.D.	6.500	0.280	10.0	5.0	24.9	10.0
165.1	165.1	7.1	3.0	1.5	7.6	3.0
6	6.625	0.280	10.1	5.1	25.3	10.1
150	168.3	7.1	3.1	1.6	7.7	3.1
8	8.625	0.322	13.3	6.7	33.3	13.3
200	219.1	8.2	4.1	2.0	10.1	4.1
10	10.750	0.365	16.7	8.4	41.8	16.7
250	273.1	9.3	5.1	2.6	12.7	5.1
12	12.750	0.375	20.0	10.0	50.0	20.0
300	323.9	9.5	6.1	3.0	15.2	6.1
14	14.000	0.375	22.2	11.7	64.2	22.9
350	355.6	9.5	6.8	5.4	19.6	7.0
16	16.000	0.375	25.5	12.4	73.9	26.4
400	406.4	9.5	7.8	6.2	22.5	8.0
18	18.000	0.375	28.9	14.5	87.2	31.1
450	457.2	9.5	8.8	7.0	26.6	9.5
20	20.000	0.375	32.2	16.1	97.3	34.8
500	508.0	9.5	9.8	7.8	29.7	10.6
24	24.000	0.375	38.9	19.5	113.0	40.4
600	609.6	9.5	11.9	9.5	34.4	12.3

Note:

For the reducing tee and branches, use the value that is corresponding to the branch size. For example: for 6" x 6" x 3" tee, the branch value of 3" is 12.8 ft (3.9).

The Fitting Size Chart is used to determine the O.D. of the pipe that the fittings is to be used with. Gruvlok Fittings are identified by either the Nominal size in inches or the Pipe O.D. in/mm.

Fitting Size

Nominal Size	O.D.
In./DN(mm)	In./mm
1	1.315
25	33.4
1 1/4	1.660
32	42.4
1 1/2	1.900
40	48.3
2	2.375
50	60.3
2 1/2	2.875
65	73.0
3 O.D.	2.996
76.1	76.1
3	3.500
80	88.9
3 1/2	4.000
90	101.6
4 1/4 O.D.	4.250
108.0	108.0
4	4.500
100	114.3
5 1/4 O.D.	5.236
133.0	133.0
5 1/2 O.D.	5.500
139.7	139.7
5	5.563
140	141.3
6 1/4 O.D.	6.259
159.0	159.0
6 1/2 O.D.	6.500
165.1	165.1
6	6.625
150	168.3
8	8.625
200	219.1
10	10.750
250	273.0
12	12.750
300	323.9
14	14.000
350	355.6
16	16.000
400	406.4
18	18.000
450	457.2
20	20.000
500	508.0
24	24.000
600	609.6

Long Radius Elbows

Fig. 7050-3D, 7057-3D, 7051-3D, 7058-3D, 7052-3D, 7053-3D

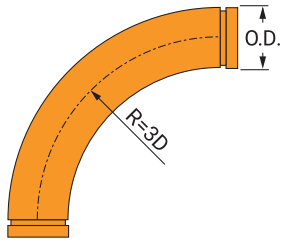

Fig. 7050-3D,
90° Elbow

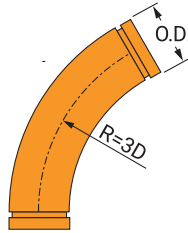

Fig. 7057-3D,
60° Elbow

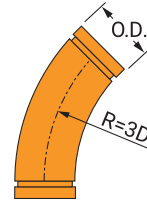

Fig. 7051-3D,
45° Elbow

Fig. 7050-3D 90° Elbow

Nominal Size	O.D.	Center to End	Approx. Wt. Ea.
In./DN(mm)	In./mm	In./mm	Lbs./kg
2	2.375	10	5.3
50	60.3	254	2.4
2½	2.875	11½	9.5
65	73.0	292	4.3
3	3.500	13	14.0
80	88.9	330	6.4
3½	4.000	14½	18.6
90	101.6	368	8.4
4	4.500	16	24.1
100	114.3	406	10.9
5	5.563	20	40.9
125	141.3	508	18.6
6	6.625	24	63.7
150	168.3	610	28.9
8	8.625	32	127.8
200	219.1	813	58.0
10	10.750	40	226.4
250	273.1	1016	102.7
12	12.750	48	332.7
300	323.9	1219	150.9
14	14.000	56	427.3
350	355.6	1422	193.8
16	16.000	64	560.1
400	406.4	1626	254.1
18	18.000	72	710.7
450	457.2	1829	322.4
20	20.000	80	879.3
500	508.0	2032	398.8
24	24.000	96	1270.3
600	609.6	2438	576.2

Fig. 7057-3D 60° Elbow

Center to End	Approx. Wt. Ea.
In./mm	Lbs./kg
7½	4.3
191	2.0
8¼	7.7
210	3.5
9¼	11.0
235	5.0
10	14.4
254	6.5
11	18.5
279	8.4
13¾	31.3
349	14.2
16½	48.8
419	22.1
22	97.9
559	44.4
27¼	173.4
692	78.7
32¾	254.8
832	115.6
38¼	327.3
972	148.5
43¾	429.0
1111	194.6
49¼	544.4
1251	246.9
54¾	673.5
1391	305.5
65½	973.0
1664	441.3

Fig. 7051-3D 45° Elbow

Center to End	Approx. Wt. Ea.
In./mm	Lbs./kg
6½	3.9
165	1.8
7¼	6.7
184	3.0
7¾	9.5
197	4.3
8½	12.3
216	5.6
9	15.7
229	7.1
11¼	26.5
286	12.0
13½	41.3
343	18.7
18	82.9
457	37.6
22½	146.9
572	66.6
27	215.9
686	97.9
31½	227.3
800	103.1
36	363.5
914	164.9
40½	461.3
1029	209.2
45	540.7
1143	245.3
53¾	824.4
1365	373.9

- 3D long radius elbows are available in sizes up to 24". Sizes 4" and below are provided with a 4" (101.6 mm) long integral tangent. Remaining sizes are provided with integral tangents with lengths equal to the nominal pipe size.
- Grooved or plain-end available - specify choice on order.
- Material: standard wall steel pipe to ASTM A 53, Grade B. (Other materials available on request).
- Bends to conform to above radii.
- C to E tolerances: 2" through 6" ± 1/8" (3.2 mm); 8" through 16" ± 1/4" (6.4 mm); 18" through 24" + 3/8" (9.5 mm).
- All weights are approximate, based on calculated weight of pipe.

Long Radius Elbows

Fig. 7050-3D, 7057-3D, 7051-3D, 7058-3D, 7052-3D, 7053-3D

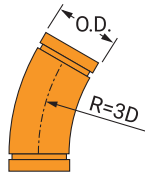

Fig. 7058-3D,
30° Elbow

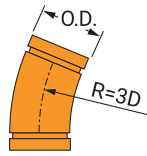

Fig. 7052-3D,
22 1/2° Elbow

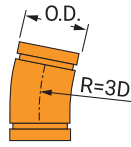

Fig. 7053-3D,
11 1/4° Elbow

Fig. 7058-3D 30° Elbow

Center to End	Approx. Wt. Ea.
In./mm	Lbs./kg
5 3/4 146	3.4 1.5
6 152	5.8 2.6
6 1/2 165	8.0 3.6
6 3/4 171	10.2 4.6
7 1/4 184	12.8 5.8
9 229	21.8 9.9
10 3/4 273	33.9 15.4
14 1/2 368	68.0 30.8
18 457	120.5 54.7
21 3/4 552	177.0 80.3
25 1/4 641	227.3 103.1
29 737	297.9 135.1
32 1/2 826	378.1 171.5
36 914	467.8 212.2
43 1/4 1099	675.7 304.1

Fig. 7052-3D 22 1/2° Elbow

Center to End	Approx. Wt. Ea.
In./mm	Lbs./kg
5 1/4 133	3.2 1.5
5 1/2 140	5.3 2.4
5 3/4 146	7.3 3.3
6 152	9.2 4.2
6 1/2 165	11.4 5.2
8 203	19.4 8.8
9 1/2 241	30.1 13.7
12 3/4 324	60.5 27.4
16 406	107.2 48.6
19 1/4 489	157.5 71.4
22 1/2 572	202.3 91.8
25 1/2 648	265.2 120.3
28 3/4 730	336.5 152.6
32 813	416.3 188.8
38 1/4 972	601.4 272.8

Fig. 7053-3D 11 1/4° Elbow

Center to End	Approx. Wt. Ea.
In./mm	Lbs./kg
4 1/2 114	2.8 1.3
4 3/4 121	4.6 2.1
5 127	6.2 2.8
5 127	7.6 3.4
5 1/4 133	9.3 4.2
6 1/2 165	15.8 7.2
7 3/4 197	24.6 11.2
10 1/2 267	49.3 22.4
13 330	87.3 39.6
15 1/2 394	128.3 58.2
18 1/4 464	164.8 74.8
20 3/4 527	216.0 98.0
23.35 593	274.1 124.3
26 660	339.2 153.9
31 787	490.0 222.3

- 3D long radius elbows are available in sizes up to 24". Sizes 4" and below are provided with a 4" (101.6 mm) long integral tangent. Remaining sizes are provided with integral tangents with lengths equal to the nominal pipe size.
- Grooved or plain-end available - specify choice on order.
- Material: standard wall steel pipe to ASTM A 53, Grade B. (Other materials available on request).
- Bends to conform to above radii.
- C to E tolerances: 2" through 6" ± 1/8" (3.2 mm); 8" through 16" ± 1/4" (6.4 mm); 18" through 24" + 3/8" (9.5 mm).
- All weights are approximate, based on calculated weight of pipe.

Fig. 7050-5D 90° Elbow
Fig. 7057-5D 60° Elbow
Fig. 7051-5D 45° Elbow
Fig. 7058-5D 30° Elbow

Fig. 7052-5D 22 1/2° Elbow
Fig. 7053-5D 11 1/4° Elbow

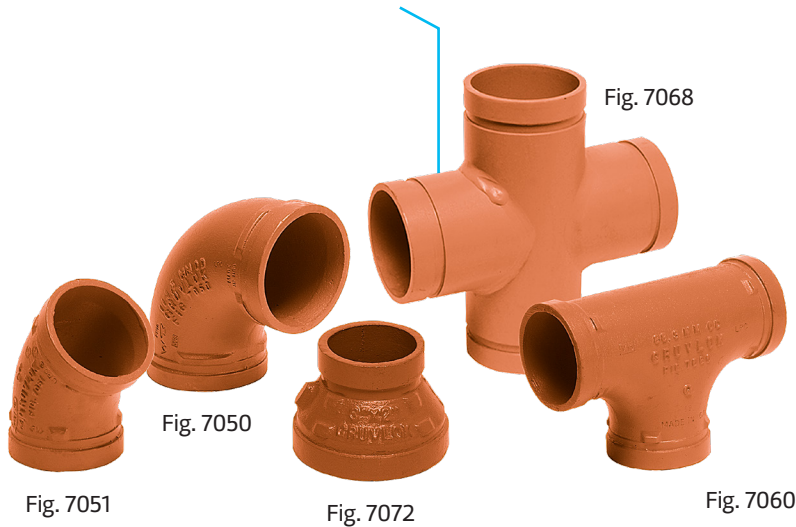

Material Specifications

Cast Fittings

Ductile iron conforming to ASTM A536, Grade 65-45-12

Malleable iron conforming to ASTM A47

Fabricated Fittings

1-12" Carbon steel, Schedule 40, conforming to ASTM A53, Grade B

14-24" Carbon steel, 0.375 wall, conforming to ASTM A53, Grade B

Coatings

Rust inhibiting paint

Color: Orange (standard)

Hot Dipped Zinc Galvanized conforming to ASTM A153 (optional)

Other Colors Available (IE: RAL3000 and RAL9000)



Gruvlok fittings are available through 24" nominal pipe size in a variety of styles. Use the Fitting Size Table to convert nominal pipe size to corresponding pipe O.D.

These fittings are designed to provide minimum pressure drop and uniform strength.

Depending on styles and size, Gruvlok fittings are provided in various materials including ductile iron, forged steel or fabricated steel.

Pressure ratings of Gruvlok standard fittings conform to those of Fig. 7001 Gruvlok coupling.

For Listings/Approval Details and Limitations, visit our website at www.asc-es.com or contact an ASC Engineered Solutions™ Sales Representative.

Long Radius Elbows

Fig. 7050-5D, 7057-5D, 7051-5D, 7058-5D, 7052-5D, 7053-5D

Flow Data - Frictional Resistance (Expressed as Equivalent Straight Pipe)

Nominal Size	O.D.	Pipe Wall Thickness	Elbow		Tee	
			90°	45°	Branch	Run
In./DN(mm)	In./mm	In./mm	Ft./m	Ft./m	Ft./m	Ft./m
1	1.315	0.133	1.7	0.9	4.4	1.7
25	33.4	3.4	0.5	0.3	1.3	0.5
1 ¼	1.660	0.140	2.3	1.2	5.8	2.3
32	42.2	3.6	0.7	0.4	1.8	0.7
1 ½	1.900	0.145	2.7	1.3	6.7	2.7
40	48.3	3.7	0.8	0.4	2.0	0.8
2	2.375	0.154	3.4	1.7	8.6	3.4
50	60.3	3.9	1.0	0.5	2.6	1.0
2 ½	2.875	0.203	4.1	2.1	10.3	4.1
65	73.0	5.2	1.2	0.6	3.1	1.2
3 O.D.	2.996	0.197	4.3	2.2	10.8	4.3
76.1	76.1	5.0	1.3	0.7	3.3	1.3
3	3.500	0.216	5.1	2.6	12.8	5.1
80	88.9	5.5	1.6	0.8	3.9	1.6
4 ¼ O.D.	4.250	0.220	6.4	3.2	16.1	6.4
108.0	108.0	5.6	2.0	1.0	4.9	2.0
4	4.500	0.237	6.7	3.4	16.8	6.7
100	114.3	6.0	2.0	1.0	5.1	2.0
5 ¼ O.D.	5.236	0.248	8.0	4.0	20.1	8.0
133.0	133.0	6.3	2.4	1.2	6.1	2.4
5 ½ O.D.	5.500	0.248	8.3	4.2	20.9	8.3
139.7	139.7	6.3	2.5	1.3	6.4	2.5
5	5.563	0.258	8.4	4.2	21.0	8.4
125	141.3	6.6	2.6	1.3	6.4	2.6
6 ¼ O.D.	6.259	0.280	9.7	4.9	24.3	9.7
159.0	159.0	7.1	3.0	1.5	7.4	3.0
6 ½ O.D.	6.500	0.280	10.0	5.0	24.9	10.0
165.1	165.1	7.1	3.0	1.5	7.6	3.0
6	6.625	0.280	10.1	5.1	25.3	10.1
150	168.3	7.1	3.1	1.6	7.7	3.1
8	8.625	0.322	13.3	6.7	33.3	13.3
200	219.1	8.2	4.1	2.0	10.1	4.1
10	10.750	0.365	16.7	8.4	41.8	16.7
250	273.1	9.3	5.1	2.6	12.7	5.1
12	12.750	0.375	20.0	10.0	50.0	20.0
300	323.9	9.5	6.1	3.0	15.2	6.1
14	14.000	0.375	22.2	11.1	55.6	22.2
350	355.6	9.5	6.8	3.4	19.6	6.8
16	16.000	0.375	25.5	12.8	64.0	25.5
400	406.4	9.5	7.8	3.9	22.5	7.8
18	18.000	0.375	28.9	14.5	72.0	28.9
450	457.2	9.5	8.8	4.4	26.6	8.8
20	20.000	0.375	32.2	16.1	80.0	32.2
500	508.0	9.5	9.8	4.9	29.7	9.8
24	24.000	0.375	38.9	19.5	110.4	38.9
600	609.6	9.5	11.9	5.9	34.4	11.9

Fitting Size

Nominal Size	O.D.
In./DN(mm)	In./mm
1	1.315
25	33.4
1 ¼	1.660
32	42.4
1 ½	1.900
40	48.3
2	2.375
50	60.3
2 ½	2.875
65	73.0
3 O.D.	2.996
76.1	76.1
3	3.500
80	88.9
3 ½	4.000
90	101.6
4 ¼ O.D.	4.250
108.0	108.0
4	4.500
100	114.3
5 ¼ O.D.	5.236
133.0	133.0
5 ½ O.D.	5.500
139.7	139.7
5	5.563
140	141.3
6 ¼ O.D.	6.259
159.0	159.0
6 ½ O.D.	6.500
165.1	165.1
6	6.625
150	168.3
8	8.625
200	219.1
10	10.750
250	273.0
12	12.750
300	323.9
14	14.000
300	323.9
16	16.000
350	355.6
18	18.000
400	406.4
20	20.000
450	457.2
24	24.000
500	508.0
24	24.000
600	609.6

Note:

For the reducing tee and branches, use the value that is corresponding to the branch size. For example: for 6" x 6" x 3" tee, the branch value of 3" is 12.8 ft (3.9).

The Fitting Size Chart is used to determine the O.D. of the pipe that the fittings is to be used with. Gruvlok Fittings are identified by either the Nominal size in inches or the Pipe O.D. in/mm.

Long Radius Elbows

Fig. 7050-5D, 7057-5D, 7051-5D, 7058-5D, 7052-5D, 7053-5D

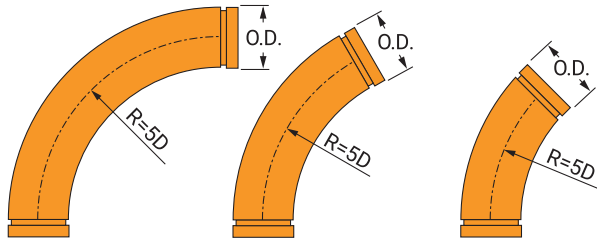

Fig. 7050-5D,
90° Elbow

Fig. 7057-5D,
60° Elbow

Fig. 7051-5D,
45° Elbow

Fig. 7050-5D 90° Elbow

Nominal Size	O.D.	Center to End	Approx. Wt. Ea.
In./DN(mm)	In./mm	In./mm	Lbs./kg
2	2.375	14	7.2
50	60.3	356	3.3
2½	2.875	16½	13.3
65	73.0	419	6.0
3	3.500	19	19.9
80	88.9	483	9.0
3½	4.000	21½	26.9
90	101.6	546	12.2
4	4.500	24	35.4
100	114.3	610	16.1
5	5.563	30	60.0
125	141.3	762	27.2
6	6.625	36	93.5
150	168.3	914	42.4
8	8.625	48	187.6
200	219.1	1219	85.1
10	10.750	60	332.4
250	273.1	1524	150.8
12	12.750	72	488.4
300	323.9	1829	221.5
14	14.000	84	627.4
350	355.6	2134	284.6
16	16.000	96	822.2
400	406.4	2438	372.9
18	18.000	108	1043.4
450	457.2	2743	473.3
20	20.000	120	1290.9
500	508.0	3048	585.5
24	24.000	144	1864.8
600	609.6	3658	845.9

Fig. 7057-5D 60° Elbow

Center to End	Approx. Wt. Ea.
In./mm	Lbs./kg
9¾	5.6
248	2.5
11¼	10.2
286	4.6
12¾	15.0
324	6.8
12¼	20.0
311	9.1
15½	26.0
394	11.8
19½	44.1
495	20.0
23¼	68.6
591	31.1
31	137.7
787	62.5
39	244.1
991	110.7
46¾	358.6
1187	162.7
54½	460.7
1384	209.0
62¼	603.8
1581	273.9
70	766.2
1778	347.5
77¾	947.9
1975	430.0
93¼	1369.3
2369	621.1

Fig. 7051-5D 45° Elbow

Center to End	Approx. Wt. Ea.
In./mm	Lbs./kg
8¼	4.8
210	2.2
9¼	8.6
235	3.9
10¼	12.5
260	5.7
11¼	16.5
286	7.5
12½	21.3
318	9.7
15½	36.1
394	16.4
18½	56.2
470	25.5
24½	112.8
622	51.2
30¾	199.9
781	90.7
37	293.7
940	133.2
43	377.3
1092	171.1
49¼	494.5
1251	224.3
55¼	627.6
1403	284.7
61½	776.4
1562	352.2
73¾	1121.6
1873	508.7

- 5D long radius elbows are available in sizes up to 24". Sizes 4" and below are provided with a 4" (101.6 mm) long integral tangent. Remaining sizes are provided with integral tangents with lengths equal to the nominal pipe size.
- Grooved or plain-end available - specify choice on order.
- Material: standard wall steel pipe to ASTM A 53, Grade B. (Other materials available on request).
- Bends to conform to above radii.
- C to E tolerances: 2" through 6" ± 1/8" (3.2 mm); 8" through 16" ± 1/4" (6.4 mm); 18" through 24" + 3/8" (9.5 mm).
- All weights are approximate, based on calculated weight of pipe.

Long Radius Elbows

Fig. 7050-5D, 7057-5D, 7051-5D, 7058-5D, 7052-5D, 7053-5D

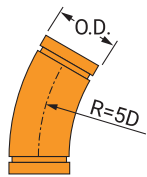

Fig. 7058-5D,
30° Elbow

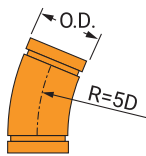

Fig. 7052-5D,
22 1/2° Elbow

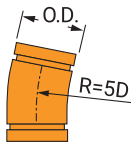

Fig. 7053-5D,
11 1/4° Elbow

Fig. 7058-5D 30° Elbow

Center to End	Approx. Wt. Ea.
In./mm	Lbs./kg
6 3/4 171	4.0 1.8
7 1/2 191	7.0 3.2
8 203	10.0 4.5
8 3/4 222	13.0 5.9
9 1/2 241	16.6 7.5
11 3/4 298	28.1 12.7
14 356	43.8 19.9
18 3/4 476	87.9 39.9
23 1/2 597	155.8 70.7
28 711	228.9 103.8
32 3/4 832	294.0 133.4
37 1/2 953	385.3 174.8
42 1/4 1073	489.0 221.8
46 3/4 1187	605.0 274.4
56 1/4 1429	873.9 396.4

Fig. 7052-5D 22 1/2° Elbow

Center to End	Approx. Wt. Ea.
In./mm	Lbs./kg
6 152	3.6 1.6
6 1/2 165	6.2 2.8
7 178	8.8 4.0
7 1/2 191	11.3 5.1
8 203	14.3 6.5
10 254	24.1 10.9
12 305	37.6 17.1
16 406	75.4 34.2
20 508	133.7 60.6
24 610	196.4 89.1
28 711	252.3 114.4
32 813	330.7 150.0
36 914	419.7 190.4
40 1016	519.2 235.5
48 1219	750.1 340.2

Fig. 7053-5D 11 1/4° Elbow

Center to End	Approx. Wt. Ea.
In./mm	Lbs./kg
5 127	3.0 1.4
5 1/4 133	5.0 2.3
5 1/2 140	6.9 3.1
5 3/4 146	8.7 3.9
6 152	10.7 4.9
7 1/2 191	18.2 8.3
9 229	28.3 12.8
12 305	56.8 25.8
15 381	100.6 45.6
18 457	147.8 67.0
21 533	189.8 86.1
24 610	248.8 112.9
27 686	315.7 143.2
30 762	390.6 177.2
35 3/4 908	564.3 256.0

- 5D long radius elbows are available in sizes up to 24". Sizes 4" and below are provided with a 4" (101.6 mm) long integral tangent. Remaining sizes are provided with integral tangents with lengths equal to the nominal pipe size.
- Grooved or plain-end available - specify choice on order.
- Material: standard wall steel pipe to ASTM A 53, Grade B. (Other materials available on request).
- Bends to conform to above radii.
- C to E tolerances: 2" through 6" ± 1/8" (3.2 mm); 8" through 16" ± 1/4" (6.4 mm); 18" through 24" + 3/8" (9.5 mm).
- All weights are approximate, based on calculated weight of pipe.

Fig. 7050-6D 90° Elbow
Fig. 7057-6D 60° Elbow
Fig. 7051-6D 45° Elbow
Fig. 7058-6D 30° Elbow

Fig. 7052-6D 22½° Elbow
Fig. 7053-6D 11¼° Elbow

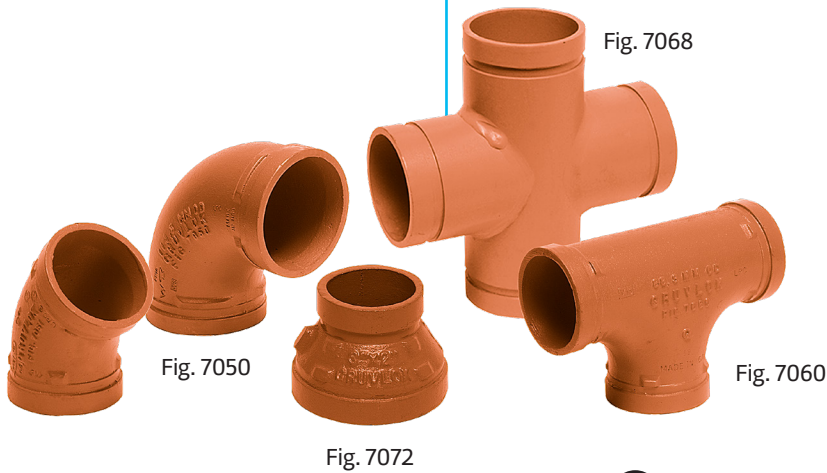

Material Specifications

Cast Fittings

Ductile iron conforming to ASTM A536, Grade 65-45-12

Malleable iron conforming to ASTM A47

Fabricated Fittings

1-12" Carbon steel, Schedule 40, conforming to ASTM A53, Grade B

14-24" Carbon steel, 0.375 wall, conforming to ASTM A53, Grade B

Coatings

Rust inhibiting paint

Color: Orange (standard)

Hot Dipped Zinc Galvanized conforming to ASTM A153 (optional)

Other Colors Available
(IE: RAL3000 and RAL9000)



Galvanized Gruvlok Fittings are NSF-61 and Low Lead Approved

Gruvlok fittings are available through 24" nominal pipe size in a variety of styles. Use the Fitting Size Table to convert nominal pipe size to corresponding pipe O.D.

These fittings are designed to provide minimum pressure drop and uniform strength.

Depending on styles and size, Gruvlok fittings are provided in various materials including ductile iron, forged steel or fabricated steel.

Pressure ratings of Gruvlok standard fittings conform to those of Fig. 7001 Gruvlok coupling.

For Listings/Approval Details and Limitations, visit our website at www.asc-es.com or contact an ASC Engineered Solutions™ Sales Representative.

Long Radius Elbows

Fig. 7050-6D, 7057-6D, 7051-6D, 7058-6D, 7052-6D, 7053-6D

Flow Data - Frictional Resistance (Expressed as Equivalent Straight Pipe)

Nominal Size	O.D.	Pipe Wall Thickness	Elbow		Tee	
			90°	45°	Branch	Run
in./DN(mm)	in./mm	in./mm	Ft./m	Ft./m	Ft./m	Ft./m
1	1.315	0.133	1.7	0.9	4.4	1.7
25	33.4	3.4	0.5	0.3	1.3	0.5
1 ¼	1.660	0.140	2.3	1.2	5.8	2.3
32	42.2	3.6	0.7	0.4	1.8	0.7
1 ½	1.900	0.145	2.7	1.3	6.7	2.7
40	48.3	3.7	0.8	0.4	2.0	0.8
2	2.375	0.154	3.4	1.7	8.6	3.4
50	60.3	3.9	1.0	0.5	2.6	1.0
2 ½	2.875	0.203	4.1	2.1	10.3	4.1
65	73.0	5.2	1.2	0.6	3.1	1.2
3 O.D.	2.996	0.197	4.3	2.2	10.8	4.3
76.1	76.1	5.0	1.3	0.7	3.3	1.3
3	3.500	0.216	5.1	2.6	12.8	5.1
80	88.9	5.5	1.6	0.8	3.9	1.6
4 ¼ O.D.	4.250	0.220	6.4	3.2	16.1	6.4
108.0	108.0	5.6	2.0	1.0	4.9	2.0
4	4.500	0.237	6.7	3.4	16.8	6.7
100	114.3	6.0	2.0	1.0	5.1	2.0
5 ¼ O.D.	5.236	0.248	8.0	4.0	20.1	8.0
133.0	133.0	6.3	2.4	1.2	6.1	2.4
5 ½ O.D.	5.500	0.248	8.3	4.2	20.9	8.3
139.7	139.7	6.3	2.5	1.3	6.4	2.5
5	5.563	0.258	8.4	4.2	21.0	8.4
125	141.3	6.6	2.6	1.3	6.4	2.6
6 ¼ O.D.	6.259	0.280	9.7	4.9	24.3	9.7
159.0	159.0	7.1	3.0	1.5	7.4	3.0
6 ½ O.D.	6.500	0.280	10.0	5.0	24.9	10.0
165.1	165.1	7.1	3.0	1.5	7.6	3.0
6	6.625	0.280	10.1	5.1	25.3	10.1
150	168.3	7.1	3.1	1.6	7.7	3.1
8	8.625	0.322	13.3	6.7	33.3	13.3
200	219.1	8.2	4.1	2.0	10.1	4.1
10	10.750	0.365	16.7	8.4	41.8	16.7
250	273.1	9.3	5.1	2.6	12.7	5.1
12	12.750	0.375	20.0	10.0	50.0	20.0
300	323.9	9.5	6.1	3.0	15.2	6.1
14	14.000	0.375	22.2	11.7	64.2	22.9
350	355.6	9.5	6.8	5.4	19.6	7.0
16	16.000	0.375	25.5	12.4	73.9	26.4
400	406.4	9.5	7.8	6.2	22.5	8.0
18	18.000	0.375	28.9	14.5	87.2	31.1
450	457.2	9.5	8.8	7.0	26.6	9.5
20	20.000	0.375	32.2	16.1	97.3	34.8
500	508.0	9.5	9.8	7.8	29.7	10.6
24	24.000	0.375	38.9	19.5	113.0	40.4
600	609.6	9.5	11.9	9.5	34.4	12.3

Fitting Size

Nominal Size	O.D.
in./DN(mm)	in./mm
1	1.315
25	33.4
1 ¼	1.660
32	42.4
1 ½	1.900
40	48.3
2	2.375
50	60.3
2 ½	2.875
65	73.0
3 O.D.	2.996
76.1	76.1
3	3.500
80	88.9
3 ½	4.000
90	101.6
4 ¼ O.D.	4.250
108.0	108.0
4	4.500
100	114.3
5 ¼ O.D.	5.236
133.0	133.0
5 ½ O.D.	5.500
139.7	139.7
5	5.563
140	141.3
6 ¼ O.D.	6.259
159.0	159.0
6 ½ O.D.	6.500
165.1	165.1
6	6.625
150	168.3
8	8.625
200	219.1
10	10.750
250	273.0
12	12.750
300	323.9
14	14.000
300	323.9
16	16.000
350	355.6
18	18.000
400	406.4
20	20.000
450	457.2
24	24.000
500	508.0
24	24.000
600	609.6

Note:

For the reducing tee and branches, use the value that is corresponding to the branch size. For example: for 6" x 6" x 3" tee, the branch value of 3" is 12.8 ft (3.9).

The Fitting Size Chart is used to determine the O.D. of the pipe that the fittings is to be used with. Gruvlok Fittings are identified by either the Nominal size in inches or the Pipe O.D. in/mm.

Long Radius Elbows

Fig. 7050-6D, 7057-6D, 7051-6D, 7058-6D, 7052-6D, 7053-6D

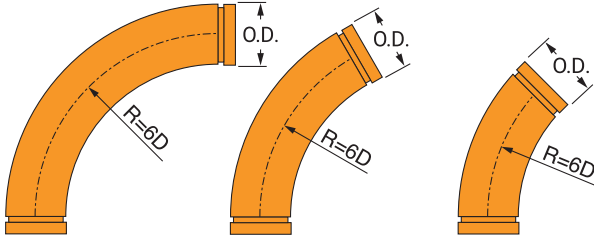

Fig. 7050-6D,
90° Elbow

Fig. 7057-6D,
60° Elbow

Fig. 7051-6D,
45° Elbow

Fig. 7050-6D 90° Elbow

Nominal Size	O.D.	Center to End	Approx. Wt. Ea.
In./DN(mm)	In./mm	In./mm	Lbs./kg
2	2.375	16	8.2
50	60.3	406	3.7
2½	2.875	19	15.2
65	73.0	483	6.9
3	3.500	22	22.9
80	88.9	559	10.4
3½	4.000	25	31.1
90	101.6	635	14.1
4	4.500	28	41.1
100	114.3	711	18.6
5	5.563	35	69.6
125	141.3	889	31.6
6	6.625	42	108.4
150	168.3	1067	49.2
8	8.625	56	217.5
200	219.1	1422	98.7
10	10.750	70	385.4
250	273.1	1778	174.8
12	12.750	84	566.2
300	323.9	2134	256.8
14	14.000	98	727.4
350	355.6	2489	329.9
16	16.000	112	953.3
400	406.4	2845	432.4
18	18.000	126	1209.7
450	457.2	3200	548.7
20	20.000	140	1496.6
500	508.0	3556	678.8
24	24.000	168	2162.0
600	609.6	4267	980.7

Fig. 7057-6D 60° Elbow

Center to End	Approx. Wt. Ea.
In./mm	Lbs./kg
11	6.3
279	2.9
12¾	11.4
324	5.2
14½	17.0
368	7.7
16¼	22.8
413	10.3
18	29.8
457	13.5
22¼	50.5
565	22.9
26¾	78.6
679	35.7
35¾	157.7
908	71.5
44¾	279.4
1137	126.7
53½	410.5
1359	186.2
62½	527.3
1588	239.2
71½	691.1
1816	313.5
80½	877.1
2045	397.8
89¼	1085.1
2267	492.2
107¼	1567.5
2724	711.0

Fig. 7051-6D 45° Elbow

Center to End	Approx. Wt. Ea.
In./mm	Lbs./kg
9	5.3
229	2.4
10¼	9.5
260	4.3
11½	14.0
292	6.4
12¾	18.6
324	8.4
14	24.1
356	10.9
17½	40.9
445	18.6
21	63.7
533	28.9
28	127.8
711	58.0
35	226.4
889	102.7
41¾	332.7
1060	150.9
48¾	427.3
1238	193.8
55¾	560.1
1416	254.1
62¾	710.7
1594	322.4
69¾	879.3
1772	398.8
83¾	1270.3
2127	576.2

- 6D long radius elbows are available in sizes up to 24". Sizes 4" and below are provided with a 4" (101.6 mm) long integral tangent. Remaining sizes are provided with integral tangents with lengths equal to the nominal pipe size.
- Grooved or plain-end available – specify choice on order.
- Material: standard wall steel pipe to ASTM A 53, Grade B. (Other materials available on request).
- Bends to conform to above radii.
- C to E tolerances: 2" through 6" ± 1/8" (3.2 mm); 8" through 16" ± 1/4" (6.4 mm); 18" through 24" + 3/8" (9.5 mm).
- All weights are approximate, based on calculated weight of pipe.

Long Radius Elbows

Fig. 7050-6D, 7057-6D, 7051-6D, 7058-6D, 7052-6D, 7053-6D

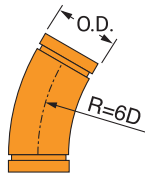

Fig. 7058-6D,
30° Elbow

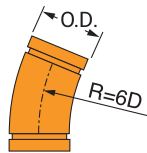

Fig. 7052-6D,
22 1/2° Elbow

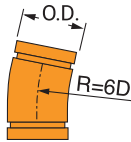

Fig. 7053-6D,
11 1/4° Elbow

Fig. 7058-6D 30° Elbow

Center to End	Approx. Wt. Ea.
In./mm	Lbs./kg
7 1/4	4.3
184	2.0
8	7.7
203	3.5
8 3/4	11.0
222	5.0
9 3/4	14.4
248	6.5
10 1/2	18.5
267	8.4
13	31.3
330	14.2
15 3/4	48.8
400	22.1
21	97.9
533	44.4
26	173.4
660	78.7
31 1/4	254.8
794	115.6
36 1/2	327.3
927	148.5
41 3/4	429.0
1060	194.6
47	544.4
1194	246.9
52 1/4	673.5
1327	305.5
62 1/2	973.0
1588	441.3

Fig. 7052-6D 22 1/2° Elbow

Center to End	Approx. Wt. Ea.
In./mm	Lbs./kg
6 1/2	3.9
165	1.8
7	6.7
178	3.0
7 1/2	9.5
191	4.3
8 1/4	12.3
210	5.6
8 3/4	15.7
222	7.1
11	26.5
279	12.0
13 1/4	41.3
337	18.7
17 1/2	82.9
445	37.6
22	146.9
559	66.6
26 1/4	215.9
667	97.9
30 3/4	277.3
781	125.8
35 1/4	363.5
895	164.9
39 1/2	461.3
1003	209.2
44	570.7
1118	258.9
52.34	824.4
1329	373.9

Fig. 7053-6D 11 1/4° Elbow

Center to End	Approx. Wt. Ea.
In./mm	Lbs./kg
5 1/4	3.2
133	1.5
5 1/2	5.3
140	2.4
5 3/4	7.3
146	3.3
6	9.2
152	4.2
6 1/2	11.4
165	5.2
8	19.4
203	8.8
9 1/2	30.1
241	13.7
12 3/4	60.5
324	27.4
16	107.2
406	48.6
19	157.5
483	71.4
22 1/4	202.3
565	91.8
25 1/2	265.2
648	120.3
28 3/4	336.5
730	152.6
31 3/4	416.3
806	188.8
38 1/4	601.4
972	272.8

- 6D long radius elbows are available in sizes up to 24". Sizes 4" and below are provided with a 4" (101.6 mm) long integral tangent. Remaining sizes are provided with integral tangents with lengths equal to the nominal pipe size.
- Grooved or plain-end available – specify choice on order.
- Material: standard wall steel pipe to ASTM A 53, Grade B. (Other materials available on request).
- Bends to conform to above radii.
- C to E tolerances: 2" through 6" ± 1/8" (3.2 mm); 8" through 16" ± 1/4" (6.4 mm); 18" through 24" ± 3/8" (9.5 mm).
- All weights are approximate, based on calculated weight of pipe.

Butterfly Valve – Epoxy Series 7700



AE7721-3
Series 7700 butterfly valve with 10 position lever lock



AE7722-3
Series 7700 butterfly valve with gear operator

AE7721-3

Used in commercial grooved-end piping systems 2" through 12".

The uniqueness of the Series 7700 Gruvlok Butterfly Valve begins with the spherical bore of the disc seat area. This facilitates a constant DISC-TO-SEAT loading that maintains a leak tight seal regardless of disc position. The stem sealing force is constant through the full disc cycle and operating torques are kept low which increases valve life. The design provides a bubble tight seal from full vacuum to 300 psi when the valve is closed. The valve is rated for dead-end service to a full pressure rating of 300 psi. Manufactured without silicone Series 7700 available upon special request.

AE7722-3

The stem-to-disc connection provides zero backlash. The high strength, corrosion resistant, stainless steel stems are blow-out proof. Each stem

is fitted with a secondary seal that also provides a lifetime lubrication chamber.

The Series 7700 valve is designed with the contractor in mind. The valve body is a rugged one-piece casting with an integral mounting base for gear operator or handle actuation, while providing room for a minimum of 2" of pipe insulation. The valve is designed and manufactured to meet or exceed the requirements of MSS SP-67.

For data on fire protection listings/ approvals, contact your ASC Engineered Solutions representative.



2" - 10" Series 7700
Certified to NSF/ANSI 61
(cold water) and Annex G
LEAD FREE

Butterfly Valve – Epoxy Series 7700

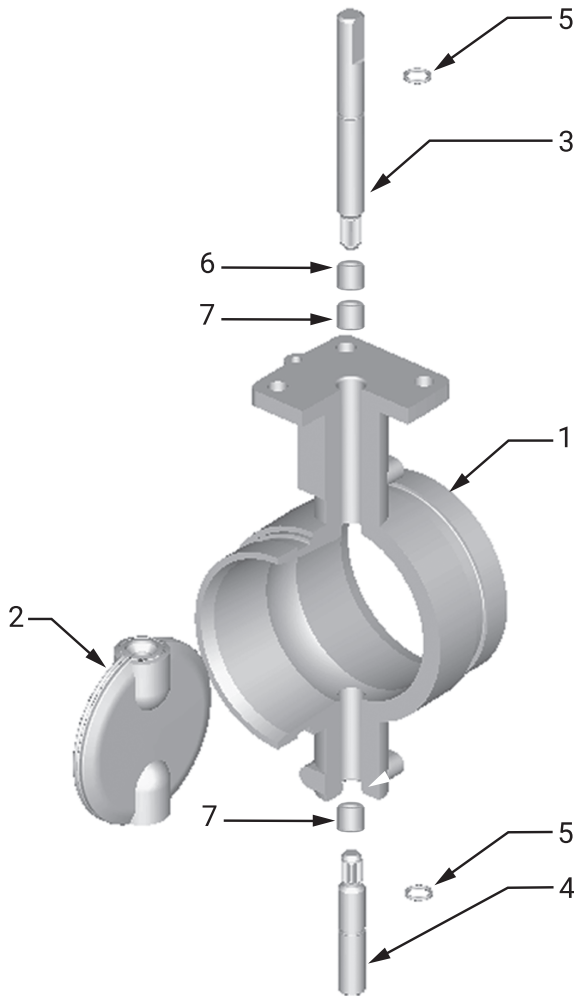

Material Specifications

1. Body

Ductile Iron conforming to ASTM A 536, Grade 65-45-12

Body Coating

Epoxy

2. Disc

Ductile Iron conforming to ASTM A 536 Grades 65-45-12

Disc Encapsulation

Properties as specified in accordance with ASTM D 2000.

Grade E (EPDM): Service Temperature Range -40°F to +230°F (-40°C to +110°C)

Recommended for water service, dilute acids, alkalis, oil-free air and many chemical services.

Not For Use In Petroleum Services.

Grade T (Nitrile): Service Temperature Range -20°F to +180°F (-29°C to +82°C)

Recommended for petroleum products, air with oil vapors, vegetable oils and mineral oils.

Not For Use In Hot Water Services.

3, 4. UPPER AND LOWER SHAFT

Type 416 Stainless Steel

5. O-RINGS

Compatible with disc coating

6, 7. TOP AND BOTTOM BRONZE SLEEVE BUSHINGS

8", 10", & 12" Valve only

Gruvlok Butterfly Valve Series 7700 (Ordering Information)

Sample Part Number 8" AE7721-3 -->	8"	A	E	77	2	1 -	3	Special
	Size	Body Style	Body Coating	Series	Disc Coating	Operator	Stem	
	2" - 12"	A	E - Epoxy	77-77XX	1 - Nitrile (Grade T) 2 - EPDM (Grade E)	0 - None 1 - 10 Pos. L/Lock 2 - Gear Operator D - Infinite Pos. w/Memory Stop 4 - Short 10 Pos. L/lock Operator	3 - 416 S.S.	MWS - Manufactured without Silicone

Note: For operator safety, hand levers on the 10" and 12" valves are not available. Hand levers on the 8" valve will be limited to 150 psi to ensure safe operation. 8" valves supplied with a hand wheel will carry the full 300 psi pressure rating..

Butterfly Valve – Epoxy Series 7700

Series 7700 Butterfly Valve Dimensions

Dimensions	Valve Size (ANSI/DN)								
	2	2½	3	4	5	6	8	10	12
In./mm	50	65	80	100	125	150	200	250	300
O.D.	2 ³ / ₈	2 ⁷ / ₈	3½	4½	5 ⁹ / ₁₆	6 ⁵ / ₈	8 ⁵ / ₈	10 ³ / ₄	12 ³ / ₄
In./mm	60.3	73.0	88.9	114.3	141.3	168.3	219.1	273.1	323.9
A	3 ³ / ₁₆	3 ¹³ / ₁₆	3 ¹³ / ₁₆	4 ⁵ / ₈	5 ¹³ / ₁₆	5 ¹³ / ₁₆	5¼	6¼	6½
	81.0	96.8	96.8	117.3	147.6	147.6	133.4	158.8	165.1
B	3	3 ³ / ₁₆	3 ¹³ / ₁₆	4¼	5	5½	6 ¹⁵ / ₁₆	8	9
	75.4	80.8	96.5	108.5	126.5	138.9	175.8	202.9	229.4
C	4 ³ / ₁₆	4 ³ / ₈	5 ¹ / ₁₆	5 ³ / ₈	5 ⁷ / ₈	6 ³ / ₈	7 ³ / ₄	9½	10½
	105.9	111.3	129.0	136.7	149.4	161.8	196.9	240.3	266.7
D	1 ¹ / ₁₆	1 ¹ / ₁₆	1 ¹ / ₁₆	1 ¹ / ₁₆	1 ¹ / ₁₆	1 ¹ / ₁₆	1 ⁵ / ₈	1 ⁵ / ₈	1 ⁵ / ₈
	26.9	26.9	26.9	26.9	26.9	26.9	41.1	41.1	41.1
E	7 ¹ / ₁₆	7 ¹ / ₁₆	7 ¹ / ₁₆	7 ¹ / ₁₆	7 ¹ / ₁₆	7 ¹ / ₁₆	¾	¾	¾
	11.1	11.1	11.1	11.1	11.1	11.1	19.1	19.1	19.1
F	3	3	3	3	3	3	5	5	5
	76.2	76.2	76.2	76.2	76.2	76.2	127.0	127.0	127.0
G	9 ¹ / ₁₆	9 ¹ / ₁₆	9 ¹ / ₁₆	9 ¹ / ₁₆	7 ⁷ / ₈	7 ⁷ / ₈	1	1¼	1¼
	14.3	14.3	14.3	14.3	22.2	22.2	25.4	31.8	31.8
H	7 ¹ / ₁₆	7 ¹ / ₁₆	7 ¹ / ₁₆	7 ¹ / ₁₆	7 ¹ / ₁₆	7 ¹ / ₁₆	½	½	½
	11.1	11.1	11.1	11.1	11.1	11.1	13.5	13.5	13.5
J	-	-	-	-	-	1/8	1 ³ / ₈	1 ⁷ / ₈	2 ³ / ₄
	-	-	-	-	-	3.3	34.8	47.0	70.1
K	3	3	3	3	3	3	5	5	5
	76.2	76.2	76.2	76.2	76.2	76.2	127.0	127.0	127.0
L	5 ⁵ / ₁₆	5½	6¼	6½	7	7½	-	-	-
	135.1	140.5	158.2	165.9	178.6	191.0	-	-	-
M	10½	10½	10½	10½	10½	10½	-	-	-
	266.7	266.7	266.7	266.7	266.7	266.7	-	-	-
N	7 ¹⁹ / ₁₆	8	8 ¹¹ / ₁₆	9	9½	10	14 ¹⁵ / ₁₆	16 ⁵ / ₈	20 ¹¹ / ₁₆
	198.0	203.3	221.1	228.7	241.4	253.9	379.2	422.7	525.3
P	4	4	4	4	4	4	8 ¹ / ₁₆	8 ¹ / ₁₆	11 ⁵ / ₈
	102.1	102.1	102.1	102.1	102.1	102.1	204.5	204.5	295.4
R	1½	1½	1½	1½	1½	1½	2 ⁵ / ₁₆	2 ⁵ / ₁₆	2 ⁹ / ₁₆
	38.2	38.2	38.2	38.2	38.2	38.2	58.5	58.5	65.5
S	2	2	2	2	2	2	2 ⁵ / ₈	2 ⁵ / ₈	3¼
	51.0	51.0	51.0	51.0	51.0	51.0	66.0	66.0	83.0
T	6 ⁵ / ₁₆	6 ⁵ / ₁₆	6 ⁵ / ₁₆	6 ⁵ / ₁₆	6 ⁵ / ₁₆	6 ⁵ / ₁₆	10 ¹³ / ₁₆	10 ¹³ / ₁₆	13 ¹³ / ₁₆
	160.3	160.3	160.3	160.3	160.3	160.3	275.3	275.3	350.3
U	5	5	5	5	5	5	12	12	18
	127.0	127.0	127.0	127.0	127.0	127.0	304.8	304.8	457.2

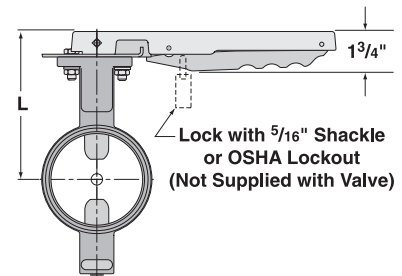
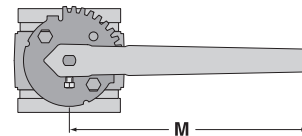
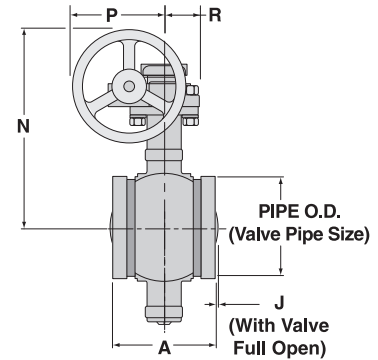
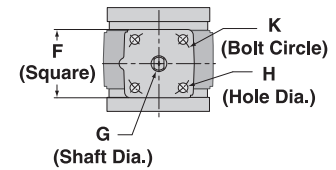
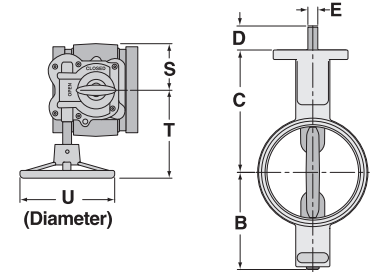

Note: 3" or 5" handwheels may be included on valves sizes 2" – 4". Contact your ASC Engineered Solutions Rep. for additional information.

Butterfly Valve – Epoxy Performance Data Series 7700

Maximum Working Pressure Rating: 300 PSI
(Commercial Applications – Sizes 2" thru 12")

C_v Values

Valve Size	O.D.	Disc Position (degrees open)							
		25°	30°	40°	50°	60°	70°	80°	90°
In./mm	In./mm								
2	2.375	4	7	19	44	48	80	111	158
50	60.3	0.3	0.5	1.3	3.0	3.3	5.5	7.7	10.9
2½	2.875	9	14	34	78	84	142	196	280
65	73.0	0.6	1	2.3	5.4	5.8	9.8	13.5	19.3
3	3.500	14	20	50	112	128	215	285	400
80	88.9	1.0	1.4	3.4	7.7	8.8	14.8	19.7	27.6
4	4.500	29	41	100	239	250	420	582	826
100	114.3	2.0	2.8	6.9	16.5	17.2	29.0	40.1	57.0
5	5.563	62	76	182	415	445	780	1,100	1,480
125	141.3	4.3	5.2	12.5	28.6	30.7	53.8	75.8	102.0
6	6.625	96	141	325	755	809	1,370	1,920	2,678
150	168.3	6.6	9.7	22.4	52.1	55.8	94.5	132.4	184.6
8	8.625	172	252	592	1,365	1,460	2,430	3,410	4,819
200	219.1	11.9	17.4	40.8	94.1	100.7	167.5	235.1	332.3
10	10.750	230	328	792	1,825	1,962	3,260	4,590	6,431
250	273.1	15.9	22.6	54.6	125.8	135.3	224.8	316.5	443.4
12	12.75	418	604	1,440	3,350	3,590	5,980	8,750	11,947
300	323.9	28.8	41.6	99.3	231.0	247.5	412.3	603.3	823.7

Headloss Equivalent Length Of Pipe

Valve Size	O.D.	Equivalent Feet of Pipe* C=120			Max. Insulating Thickness
		Sch. 10	Sch. 30	Sch. 40	
In./mm	In./mm	Ft./m			In./mm
2	2.375	5.8	-	4.7	2
50	60.3	1.8	-	1.4	50
2½	2.875	5.1	-	3.7	2½
65	73.0	1.6	-	1.1	65
3	3.500	9.6	-	7.2	2
80	88.9	2.9	-	2.2	50
4	4.500	7.5	-	5.7	2½
100	114.3	2.3	-	1.7	65
5	5.563	7.0	-	5.6	2½
125	141.3	2.1	-	1.7	65
6	6.625	6.1	-	4.8	2½
150	168.3	1.9	-	1.5	65
8	8.625	6.3	5.7	-	2½
200	219.1	1.9	1.7	-	65
10	10.750	11.3	10.2	-	3
250	273.1	3.4	3.1	-	80
12	12.750	8.4	7.4	-	3½
300	323.9	2.6	2.3	-	90

*The equivalent feet of pipe is based on the Hazen and Williams formula and the flow rates typically used with each size valve.

Valve Weight And Torque Values

Valve Size	O.D.	*Approx. Wt. Ea.	Operating Pressure				
			50 PSIG	100 PSIG	150 PSIG	200 PSIG	300 PSIG
In./mm	In./mm	Lbs./Kg	†Breakaway Torque (In. - Lbs) / N-m				
2	2.375	5	72	90	100	120	200
50	60.3	2.3	8.1	10.2	11.3	13.6	22.6
2½	2.875	10	105	126	144	162	250
65	73.0	4.5	11.9	14.2	16.3	18.3	28.2
3	3.500	11	126	139	168	195	425
80	88.9	5.0	14.2	15.7	19.0	22	48.0
4	4.500	15	265	285	320	355	800
100	114.3	6.8	29.9	32.2	36.2	40.1	90.4
5	5.563	20	491	578	615	674	850
125	141.3	9.0	55.5	65.3	69.5	76.2	96.0
6	6.625	46	625	678	760	820	1,650
150	168.3	20.9	70.6	76.6	85.9	92.7	186.4
8	8.625	68	1,170	1,400	1,640	1,760	3,200
200	219.1	30.8	132.2	158.2	185.3	198.9	361.6
10	10.750	78	1,930	2,375	2,860	3,100	6,000
250	273.1	35.4	218.1	268.4	323.2	350.3	678.0
12	12.75	91	2,900	3,420	4,760	5,600	11,000
300	323.9	41.3	327.7	386.4	537.9	632.8	1,242.9

† These values are valid for water and lubricating fluid service only. Contact ASC Engineered Solutions for information on torques for dry and non-lubricating fluid service.

*Weights may vary based on valve options selected.

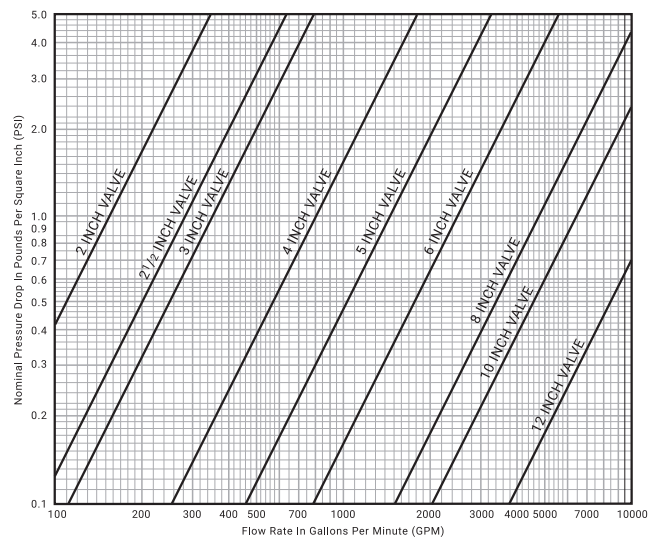

Butterfly Valve Series 8000GR

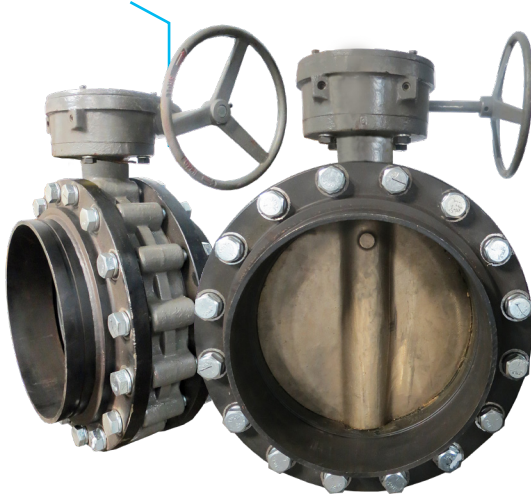

Butterfly Valve Performance Data

Pressure Ratings:

150 PSIG (10.3 bar) WOG (non-shock)
 200 PSIG (13.8 bar) WOG (non-shock)
 Special order – available upon request.
 29.5" (750 mm) Hg Vacuum Service

Temperature Ratings

Grade E (EPDM):

-40°F to 230°F (-40°C to 110°C)
 (Service Temperature Range)
 Recommended for water service, dilute acids,
 alkaline, oil-free air and many chemical services.
 Not For Use In Petroleum Services.

Grade T (Nitrile):

-20°F to 180°F (Service Temperature Range)
 (-29°C to 82°C)
 Recommended for petroleum products, air
 with oil vapors, vegetable oils and mineral oils.
 Not For Use In Hot Water Services.

Features

- Up to 150 psig (10.3 bar) WOG (non-shock) in Cast Iron
- Up to 200 psig (13.8 bar) WOG (non-shock) in Ductile Iron
- Outstanding flow characteristics
- Low torque operation
- Superior flow control
- Streamline profile disc
- Suitable for HVAC applications
- Vacuum service to 29.5" (750 mm) Hg
- End-of-line service capabilities

Fig. 8000GR Weight

Valve Size ANSI	O.D.	Weight	
		Valve Only	Valve with Gear Operator
In./DN(mm)	In./mm	Lbs./Kg.	Lbs./Kg.
14	14	354	397
350	355.6	160.6	180.1
16	16	428	538.5
400	406.4	194.1	244.3
18	18	524	679.0
450	457.2	237.7	308.0
20	20	704	858.0
500	508.0	319.3	389.2
24	24	1,027	1,324.5
600	609.6	465.8	600.8

Butterfly Valve Series 8000GR

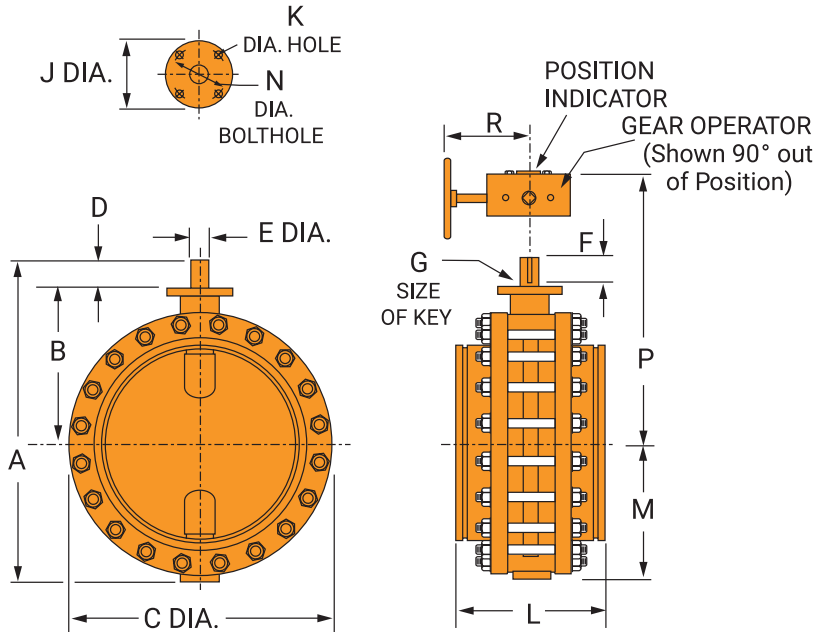

Material Specifications

Body

Cast Iron - ASTM A126 CL.B, Epoxy Coated
Ductile Iron - ASTM A536, Epoxy Coated

Extension Body

Pipe - ASTM A53 Steel
Flange - ANSI B16.42 Forged Steel

Liner

Grade E (EPDM)
Grade T (Nitrile)

Note: Stem O-Ring material matches Liner

Disc

Stainless Steel - ASTM A351
Aluminum Bronze - ASTM B148 C95400
Nickel Plated Ductile Iron - ASTM A536 Grade 65-45-12

Drive Shaft

Stainless Steel - ASTM A 582 Type 416
Stainless Steel - ASTM A 276 Type 316

Bottom Shaft

Stainless Steel - ASTM A 582 Type 416
Stainless Steel - ASTM A 276 Type 316

Plug

Cast Iron - ASTM A 126 CL.B

Upper Bearing

Reinforced Nylon

Lower Bearing

Reinforced Nylon

Grounding Spring (14" - 20"

Stainless Steel 302

Grounding Ball (24" Only

AISI-1022

Tension Screw (24" Only

AISI-1020

Introduction

Couplings

Outlets

Fittings

Valves & Accessories

High Pressure

CTS Copper System

DI-Electric Nipples

Plan-End Fittings

HDPE Couplings

Socket-Fittings

Stainless Steel Method

Roll Groovers

Installation & Assembly

Special Coatings

Design Services

Technical Data

Master Format 3 Part Specs.

Pictorial Index

Butterfly Valve Series 8000GR

Series 8000GR Butterfly Valves Dimensions

Valve Size ANSI	O.D.	A	B	C	D	E	F	G	J	K	L	M	N	P	R
In./DN(mm)	In./mm	In./mm	In./mm	In./mm	In./mm	In./mm	In./mm	In./mm	In./mm	In./mm	In./mm	In./mm	In./mm	In./mm	In./mm
14	14.0	27.1	13.5	21.0	2.0	1.6	1.5	0.4	6.5	5.3	13.1	11.6	5.3	17.3	13.4
350	355.6	687.3	342.9	533.4	50.8	41.4	38.1	9.7	165.1	133.4	331.7	293.6	133.4	438.2	340.4
16	16.0	29.4	14.8	23.5	2.0	1.6	1.5	0.4	6.5	5.3	14.1	12.7	5.3	18.8	13.4
400	406.4	747.8	374.7	596.9	50.8	41.4	38.1	9.7	165.1	133.4	357.1	322.3	133.4	476.3	340.4
18	18.0	32.1	15.5	25.0	3.0	2.1	2.4	0.5	9.5	7.5	15.1	13.6	7.5	19.6	12.6
450	457.2	816.1	393.7	635.0	76.2	54.1	60.3	12.7	241.3	190.5	382.5	346.2	190.5	498.6	320.0
20	20.0	34.9	16.8	27.5	3.0	2.1	2.4	0.5	9.5	7.5	16.1	15.1	7.5	20.9	12.6
500	508.0	886.0	425.5	698.5	76.2	54.1	60.3	12.7	241.3	190.5	407.9	384.3	190.5	530.4	320.0
24	24.0	40.5	19.4	32.1	3.1	2.1	2.4	0.5	7.5	7.5	17.1	18.1	7.5	25.0	12.6
600	609.6	1028.4	492.0	815.3	77.7	54.1	60.3	12.7	190.5	190.5	433.3	458.7	190.5	635.0	320.0

Series 8000GR Butterfly Valves (Ordering Information)

Sample Part Number 24" GD-82837 -->	24" Valve Size	G Body Style	D- Body	8 Series	2 Seat Material	8 Disc Material	3 Operator	7 Stem
	14"	G - Grooved	C - 150 PSI Service	8 - 8000	1 - Nitrile	0 - Nickel Plated Ductile Iron	0 - None	6 - 416 S.S. with RTFE Bearing
	16"		D - 200 PSI Service		2 - EPDM		2 - Gear Operator	
	18"					7 - 316 S.S.	3 - Pneumatic	7 - 316 S.S. with RTFE Bearing
	20"					8 - Bronze (Al-Brz.)	4 - Electric	
	24"						5 - Spring Return Pneumatic	
							6 - Square Nut (with Gear Operator)	
							7 - Chain Wheel (with Gear)	

Butterfly Valve Series 8000GR

Torque is the rotary effort required to operate a valve. This turning force in a butterfly valve is determined by three factors; the friction of the disc and seat due to interference for sealing, bearing friction, and fluid dynamic torque. Breakaway torque is the total of the torques resulting from bearing friction and disc /seat interference friction at a given pressure differential. This value is normally the highest required torque to operate a valve, and is used to size the actuator. Listed below are recommended sizing torques.

Note: These values include a safety factor and are for gases, including nonlubricating or dry gases, at 70 °F. Values for water and lubricating fluids would be reduced. Consult your ASC Engineered Solutions Sales Office for additional application information.

Actuator Sizing For General Service Application Series 8000GR Breakaway Torque

Line Pressure (PSI)/Bar	Valve Size (In.)				
	14	16	18	20	24
50 3.4	6,246 706	8,262 934	10,800 1,220	13,662 1,544	20,250 2,288
100 6.9	7,200 814	9,900 1,119	13,050 1,475	16,650 1,881	24,300 2,746
150 10.3	8,262 934	11,400 1,288	15,300 1,729	19,650 2,220	28,330 3,201

C_v VALUES (WATER @ 70°F SP. GR. = 1.00)

Valve Size In./mm	Disc Position (Degrees Open)							
	20°	30°	40°	50°	60°	70°	80°	90°
14 350	335	670	1,226	1,935	2,893	4,406	6,752	9,578
16 400	443	886	1,622	2,560	3,827	5,829	8,933	12,671
18 450	567	1,138	2,075	3,275	4,896	7,457	11,429	16,211
20 500	711	1,422	2,609	4,116	6,156	9,377	14,371	20,385
24 600	1,038	2,078	3,792	5,985	8,947	13,628	20,887	29,627

Fluid Dynamic Torque is the force exerted when a fluid passes over the surface of the butterfly valve disc. The magnitude of this force is dependent on valve size, disc opening and flow through the valve. Typically, fluid dynamic torque is a maximum at an approximate 75° disc opening. Generally, the effects of dynamic torque can be ignored when the velocity is less than 15 feet/second for liquids and 15,000 feet/minute for gases to minimize the effects of turbulence on the valve. For applications above these limits, consult engineering.

The formula for determining the velocity for liquids is:

$$V = 0.0022 \frac{Q}{A}$$

V = Velocity of liquid (feet/second)

Q = Flow (gallons/minute)

A = Area of upstream pipe (sq. ft.)
See "Area of Pipe" chart

The formula for determining the velocity of gases:

$$Vg = \frac{Qf}{A}$$

Vg = Velocity of gas (feet/minute)

Qf = Flow of gas @ flowing condition* (cubic feet/minute)

A = Area of upstream pipe (sq. ft.)
See "Area of Pipe" Chart

Area of Pipe

Pipe Size (Sch 40)	Area
	In./mm Sq. ft./Sq. cm
14 350	0.940 873.29
16 400	1.227 1,140
18 450	1.553 1,443
20 500	1.931 1,794
24 600	2.792 2,594

*Flowing condition means at temperature and pressure of gas stream in the valve

Butterfly Valves Fig. 70G



The Fig. 70G Butterfly Valve is designed for use with Gruvlok couplings, an ASC Engineered Solution, for fast and easy installation on grooved pipe. The valve body is fully rubber lined in EPDM or Nitrile material. A 316 Stainless Steel Disc is standard. The valve is supplied with a two position lockable handle.

Grooved ends conform to the requirements of AWWA C606.

Not intended for use in potable water systems.

Performance

Pressure Rating: 200 psi (13.8 bar) maximum working pressure.

The valve must not be installed with the disc in the fully open position. The disc must be partially closed so that no part is protruding past the end of the valve body during installation.

Material Specifications

Housing

Ductile iron conforming to ASTM A 536, Grade 65-45-12, painted.

Body

Carbon steel, elastomer lined

Body Lining

Grade E (EPDM):

-40°F to 230°F (-40°C to 110°C)

(Service Temperature Range)

Recommended for water service, dilute acids, alkaline, oil-free air and many chemical services.

Not For Use In Petroleum Services.

Grade T (Nitrile):

-20°F to 180°F (Service Temperature Range)

(-29°C to 82°C)

Recommended for petroleum products, air with oil vapors, vegetable oils and mineral oils.

Not For Use In Hot Water Services.

Upper & Lower Stem

416 Stainless Steel

DISC

316 Stainless Steel

HOUSING BOLTS & NUTS

Heat treated, oval-neck track head bolts conforming to ASTM A-183 Grade 2 with a minimum tensile strength of 110,000 psi and heavy hex nuts of carbon steel conforming to ASTM A-563 Grade A or Grade B, or SAE J995 Grade.

2. Bolts and nuts are provided zinc electroplated.

Butterfly Valves Fig. 70G

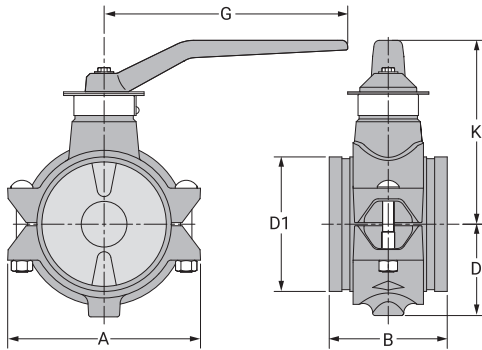

Nominal Size	Nominal Dimensions						Approx. Wt. Ea.
	A	B	D	D1	K	G	
In./DN(mm)	In./mm	In./mm	In./mm	In./mm	In./mm	In./mm	Lbs./Kg.
2	4.06	3.19	1.87	2.37	2.37	5.5	3.50
50	103	81	48	60	60	140	1.6
3	5.62	3.81	2.75	3.50	3.50	7.00	7.00
80	143	97	70	89	89	178	3.2
4	7.00	4.56	3.50	4.50	4.50	9.00	12.00
100	178	116	88.9	114	114	229	5.5
6	9.5	5.81	4.50	6.63	6.63	12.00	30.00
150	241	148	114	168	168	305	13.6

C_v Values

Nominal Diameter	Size		Flow Coefficients - CV Full Open Valve
	Actual Outside Diameter		
In./mm	In./mm		
2	2.375		74
50	60.3		-
3	3.500		173
80	88.9		-
4	4.500		829
100	114.3		-
6	6.625		1287
150	168.3		-

C_v values for flow of water are with a full open valve.

Flow Characteristics

The chart below expresses the flow of water through a full open valve.

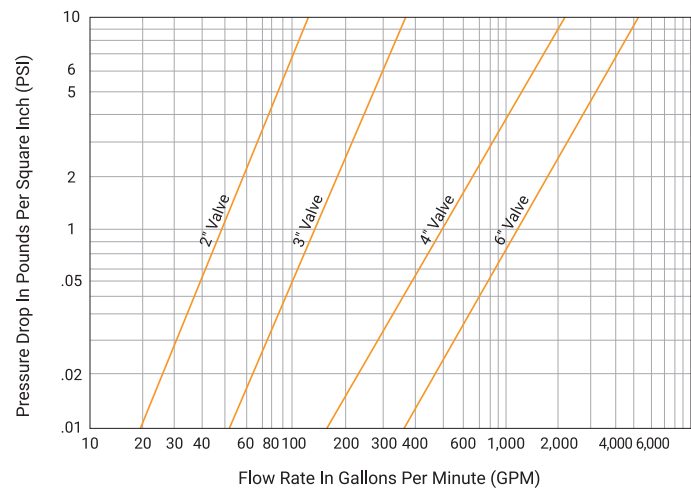

Gruvlok® Butterfly Valve Fig. 1700G

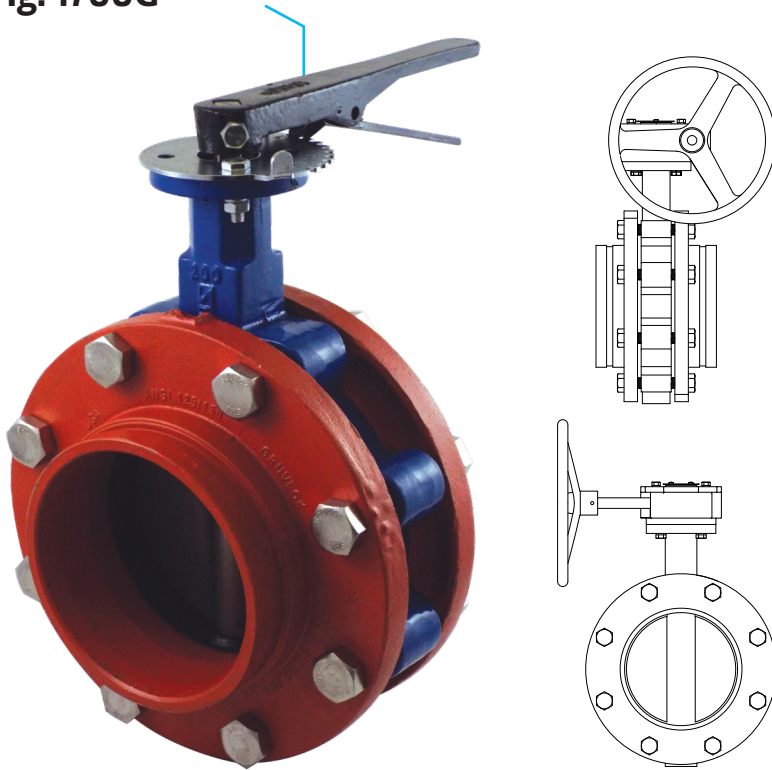

Material Specifications

Housing

Ductile Iron conforming to ASTM A536, Grade 65-45-12

Coatings*

Flange Adapters: Rust inhibiting paint
(Color: Orange)

Valve: Fusion bonded epoxy
(Color: Blue)

Seat

EPDM -30°F to 275°F

Nitrile -20°F to 180°F

Operator

10 Position Lockable Lever Handle

Gear Operator

Bare Stem

*For other coating requirements, contact an ASC Engineered Solutions™ Representative.

Our figure 1700G grooved end butterfly valve is offered in 2" through 12" sizes and is designed to be used in standard mechanical system applications up to 200 psi and temperatures ranging from -30°F to 275°F.

Features

- 316 Stainless Steel Disc
- 416 Stainless Steel Stem
- Pinless Disc & Stem Design
- Bi-directional
- Suitable for Dead End Service
- Seat design eliminates the need for flanged gaskets
- ISO 5211 Mounting Pad
- MSS SP-25 Markings
- MSS SP-67
- API 609
- EPDM seat -30°F to 275°F

Gruvlok® Butterfly Valve Fig. 1700G

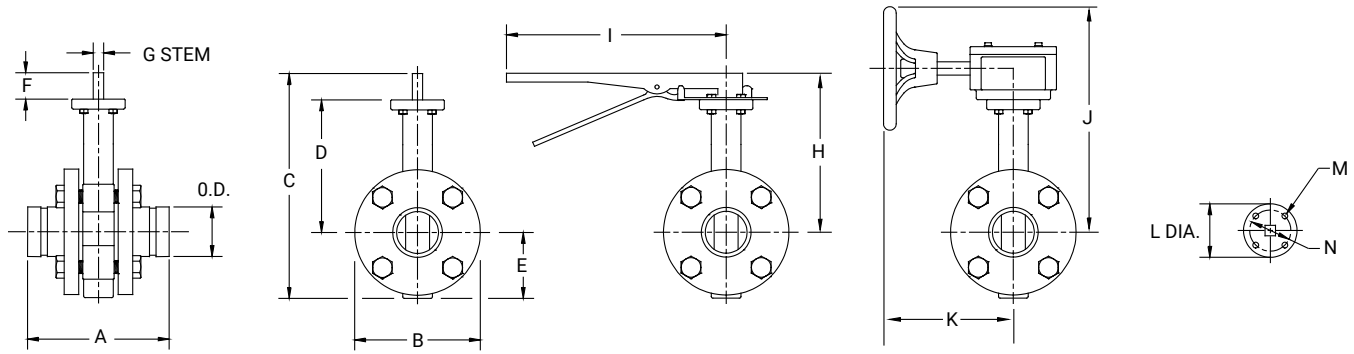

Series 17 Butterfly Valve Dimension (inches)

Nominal Size*	O.D.	A	B	C	D	E	F	G	H	I	J	K	L	M	N	Weight
2	2.375	6.77	6	10.74	6.33	3.15	1.26	0.35	7.59	6.39	10.78	6.1	2.56	0.27	1.96	20.23
2 ½	2.875	6.87	7	11.65	6.89	3.5	1.26	0.35	8.15	10.5	11.34	6.1	2.56	0.27	1.96	24.64
3	3.5	6.93	7.5	12.12	7.12	3.74	1.26	0.35	8.38	10.5	11.57	6.1	2.56	0.27	1.96	27.97
4	4.5	7.65	9	13.62	7.87	4.49	1.26	0.43	9.13	10.5	12.32	6.1	3.54	0.39	2.76	44.43
5	5.563	7.78	10	14.64	8.38	5	1.26	0.55	9.64	10.5	12.83	6.1	3.54	0.39	2.76	58.79
6	6.625	7.8	11	15.63	8.89	5.48	1.26	0.55	10.15	10.5	13.34	6.1	3.54	0.39	2.76	71.03
8	8.625	8.49	13.5	18.89	10.23	6.89	1.77	0.67	12	14.21	17.86	8.74	4.92	0.47	4.01	99.22
10	10.75	9.5	16	21.26	11.49	8	1.77	0.86	13.26	19.64	19.17	8.74	4.92	0.47	4.01	169.04
12	12.75	10.15	19	22.8	13.26	7.77	1.77	0.86	15.03	19.64	20.94	8.38	5.51	0.47	4.01	244.25

Published weights for 2" through 8" sizes include lever operator. 10" and 12" size weights include gear operator.

- Introduction
- Couplings
- Outlets
- Fittings
- Valves & Accessories
- High Pressure
- CTS Copper System
- D-I-Electric Nipples
- Plan-End Fittings
- HDPE Couplings
- Sock-It® Fittings
- Stainless Steel Method
- Roll Groovers
- Installation & Assembly
- Special Coatings
- Design Services
- Technical Data
- Master Format 3 Part Specs.
- Pictorial Index

Gruvlok® Butterfly Valve Fig. 1700G

Technical Information

Size	Gear Op			C _v									Torque			
	Output Lbs	Ratio	Gear Box	10°	20°	30°	40°	50°	60°	70°	80°	90°	50 psi	100 psi	150 psi	200 psi
2	1504	24:1	1 Stage	0.1	5	12	24	45	64	90	125	135	70	105	108	115
2-½	1504	24:1	1 Stage	0.2	8	20	37	65	98	144	204	220	100	150	136	152
3	1504	24:1	1 Stage	0.3	12	22	39	70	116	183	275	302	150	250	192	204
4	1504	24:1	1 Stage	0.5	17	36	78	139	230	364	546	600	230	260	328	352
5	1504	24:1	1 Stage	0.8	29	61	133	237	392	620	930	1022	350	530	512	548
6	1504	24:1	1 Stage	2	45	95	205	366	605	958	1437	1579	460	680	831	907
8	6195	30:1	1 Stage	3	89	188	408	727	1202	1903	2854	3136	740	1110	1527	1697
10	6195	30:1	1 Stage	4	151	320	694	1237	2947	3240	4859	5340	1330	1880	2530	2857
12	12620	50:1	1 Stage	5	234	495	1072	1911	3162	5005	7507	8250	2260	3150	3794	4338

Size (in)	Pressure Rating (psi)	Temperature Rating (°F)			
		EPDM		Buna N	
		Min	Max	Min	Max
2 - 8	200	-30	275	10	180

Published weights for 2" through 8" sizes include lever operator. 10" and 12" size weights include gear operator.

Large Diameter Butterfly Valve with Gear Operator Model B333



The Model B333 Large Diameter Butterfly Valve provides efficient control of fluid flow in piping systems. It is a grooved-end bubble tight shut-off valve with end-to-end dimensions that meet MSS SP-67, Table 4 and a mounting pad that meets ISO 5211 for the mounting of power actuators. The valve is capable of bidirectional fluid flow at working pressures to 300 psi (20 bar) and may be positioned in any orientation.

The 14 to 24 inch (DN350 to DN600) Model B333 Butterfly Valve is configured with a worm type gear operator and consists of an epoxy powder coated ductile iron body and EPDM or Nitrile (NBR) rubber encapsulation dual-seal disc. The body and disc construction provides for increased strength and durability. The disc seal and body coating are compatible with a variety of chemicals and temperature ranges. Contact your ASC Representative for specific recommendations on seal and coating selections.

Maximum Working Pressure: 300 psi (20 bar), non-shock cold water

Material Specifications

Valve Body & Disc

Ductile iron conforming to ASTM A536, Gr. 65-45-12 and/or to ASTM A395 Gr. 65-45-15

Stem Seals

O-Ring, EPDM

Body Coating

Epoxy powder coating, black color

Disc Encapsulation

Grade "E" EPDM, Grade "T" Nitrile (NBR)

Upper and Lower Shafts

Stainless steel conforming to ASTM A582, Type 410

Gear Operator Housing

Cast iron, conforming to ASTM A126-B

Set Screw

Cr-Mo Steel

Hex Nut

Carbon Steel

Spring Pin

Spring Steel

Seat Material:

- Grade "E" EPDM – For service temperatures from -30°F to 200°F (-34°C to 93°C). Recommended for water service, dilute acids, alkalis, oil-free air, and many chemical services.

Note: Not recommended for use in petroleum services.

- Grade "T" Nitrile – For service temperatures from -20°F to 180°F (-29°C to 82°C). Recommended for petroleum products, air with oil vapors, vegetable oils, and mineral oils. They are not recommended for use in hot water services.

Note: Not recommended for use in hot water services.

Contact an ASC Engineered Solutions Sales Representative for specific recommendations on seat material.

Large Diameter Butterfly Valve with Gear Operator Model B333

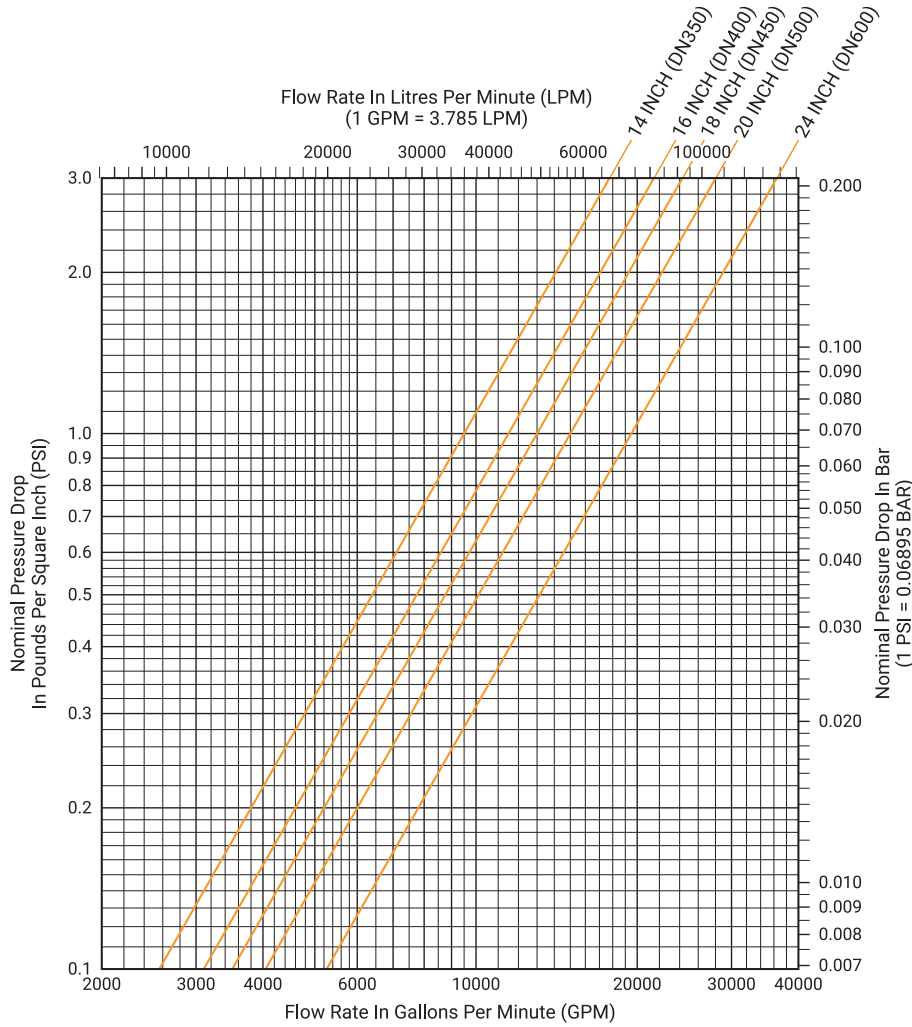

Note: For design purposes, a safety factor of 15% to 20% should be applied to the values in the above table.

Large Diameter Butterfly Valve with Gear Operator Model B333

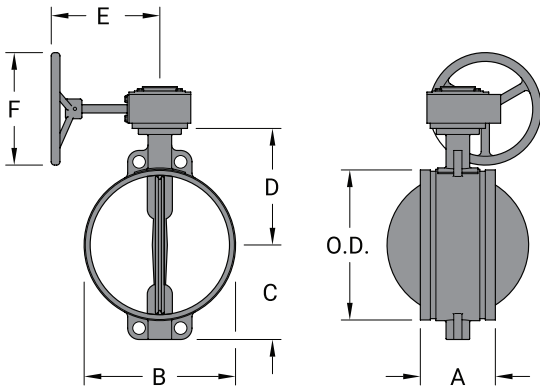

B333 Large Diameter Butterfly Valve

Valve Size	O.D.	Operating Torque	Dimensions						Approx. Wt. Ea.
			A	B	C	D	E	F	
In./mm	In./mm	In.-lb./Nm	In./mm	In./mm	In./mm	In./mm	In./mm	In./mm	Lbs./Kg
14	14.000	3000	7.00	14.37	8.82	10.86	9.5	12.00	130.0
350	355.6	339	178	365	224	276	242	305	59
16	16.000	4000	7.00	16.38	9.76	11.89	9.5	12.00	147.4
400	406.4	452	178	416	248	302	242	305	67
18	18.000	5500	8.00	18.50	11.14	13.78	11.40	16.20	223.5
450	457.2	621.5	203	470	283	350	290	412	101.4
20	20.000	8000	8.50	20.75	12.36	15.08	11.40	16.20	292.6
500	508.0	904	216	527	314	383	290	412	133.0
24	24.000	9500	10.00	24.76	14.49	17.83	11.40	16.20	352.0
600	609.6	1073.5	254	629	368	463	290	412	160.0

These torque values were derived from test data with non-lubricated valves in water, non-pressurized at ambient temperatures
For information on alternative sizes, contact an ASC Engineered Solutions Sales Representative.
Note: The torque values are based on liquid applications. For dry or non-lubricating applications add a 25% service factor to the above values.

Gear Operator Mounting Dimensions

Valve Size	PCD Dia.	Dimensions	
		Bolt Size K	S
In./mm	In./mm	In./mm	In./mm
14	4.90	M12	0.94
350	125		24.0
16	5.5	M16	1.44
400	140		36.6
18	5.50	M16	1.736
450	140		44.1
20	6.50	M20	2.04
500	165		52.0
24	6.50	M20	2.04
600	165		52.0

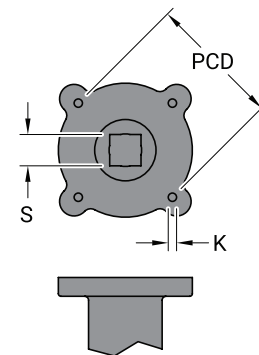

Low Profile Butterfly Valve Series 8100

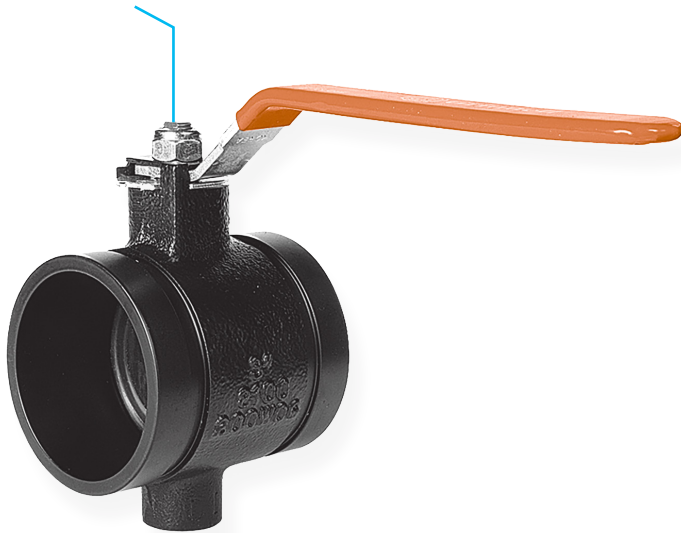

The Series 8100 Low Profile Butterfly Valve has a rated working pressure of 300 psi (20.7 bar) and provides efficient control of fluid in piping systems. Flow can be from either direction and the valve may be positioned in any orientation. The ductile iron body is epoxy-coated to resist atmospheric corrosion. The disc is EPDM encapsulated ductile iron compatible with a variety of chemicals and temperature ranges.

Maximum Working Pressure: 300 psi (20.7 bar)

Material Specifications

Body

Ductile iron conforming to ASTM A536

Body Coating

Black Epoxy-Coated

Disc

Ductile iron conforming to ASTM A 536

Disc Seal:

- Grade "E" EPDM encapsulated rubber -20°F to 250°F (-29°C to 121°C) with intermittent service at 250°F (121°C) and continuous service at 225°F (107°C)
- Optional: Grade "T" Nitrile encapsulated rubber -20°F to 180°F (-29°C to 82°C)

Stem

Two-piece stainless steel, splines conforming to AISI 420

Stem Seal

EDPM O-rings, upper and lower stem

Handle

Zinc-plated carbon steel

Low Profile Butterfly Valve Series 8100

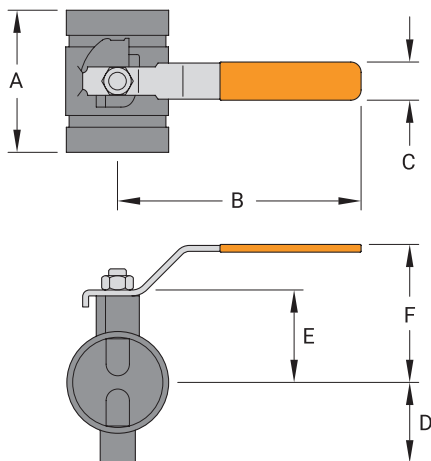

Valve Size	O.D.	Dimensions						Approx. Wt. Ea.
		A	B	C	D	E	F	
2 50	2.375 60.3	3.4 87.4	6.0 154.4	1.0 25.4	1.8 46.0	2.3 59.0	3.2 81.0	5.0 2.3
2½ 65	2.875 73.0	3.8 96.8	6.0 154.4	1.0 25.4	2.1 52.3	2.4 92.9	3.6 91.9	7.0 3.2
3 80	3.5 88.9	3.8 96.8	8.4 214.4	1.0 25.4	2.6 66.5	2.7 98.1	4.3 108.0	8.0 3.6
4 100	4.5 114.3	4.6 117.9	8.4 214.4	1.0 25.4	3.3 84.1	3.3 84.1	4.9 125.5	12.0 5.4
5 125	5.563 141.3	5.2 132.4	12.3 311.2	1.3 31.8	3.9 99.0	3.9 99.0	5.8 147.6	-
6 150	6.625 168.3	5.3 133.4	12.3 311.2	1.3 31.8	4.4 113.3	4.4 113.3	7.0 177.8	19.0 8.6

- Introduction
- Couplings
- Outlets
- Fittings
- Valves & Accessories
- High Pressure
- CTS Copper System
- DI-Electric Nipples
- Plain-End Fittings
- HDPE Couplings
- Socket-Fittings
- Stainless Steel Method
- Roll Groovers
- Installation & Assembly
- Special Coatings
- Design Services
- Technical Data
- Master Format 3 Part Specs.
- Pictorial Index

PVC Butterfly Valve (Spline x Spline) Model B8200L



Material Specifications

Body

Ductile iron conforming to ASTM A536, Gr. 65-45-12

Body Coating

Black Epoxy-Coated

Disc

Ductile iron conforming to ASTM A 536, Grade 65-45-12

Disc Seal

Grade "T" Nitrile encapsulated rubber

Stem

Two-piece Type 316 Stainless Steel Splines

Stem Seal

EPDM O-rings, upper and lower stem

Handle

Zinc-plated carbon steel

Model B8200L Butterfly Valves are available in sizes 2 through 8 inch diameters. Precision machined grooves in the valve body provide easy alignment of the valve and compatible PVC couplings, allowing for the insertion of the spline to connect the Model B8200L Valve to the PVC piping system. Flow may enter the valve from either direction and valve can be orientated in any direction.

The valve efficiently controls the flow of fluid through the use of a 10-position lever lock plate that has full open, closed, and graduated intermediate locking positions. The lever handle may be pad-locked in any of the positions, including full open and closed to prevent tampering.

The valve body is constructed of ductile iron with a tough epoxy-coating. The disc is Nitrile coated ductile iron construction. The body and disc construction provide high strength and durability as well as compatibility with a wide variety of chemicals. Type 316 Stainless Steel Stems have EPDM O-rings as back-up seals.

Model B8200L Butterfly Valves have a rated working pressure of 320 psi (22 bar), which equals or exceeds the pressure rating of all components. The working temperature range of the valve is from 32°F to 140°F (0°C to 60°C).

Maximum Working Pressure: 320 psi (22 bar)

Working Temperature Range: 32°F to 140°F (0°C to 60°C)

PVC Butterfly Valve (Spline x Spline) Model B8200L

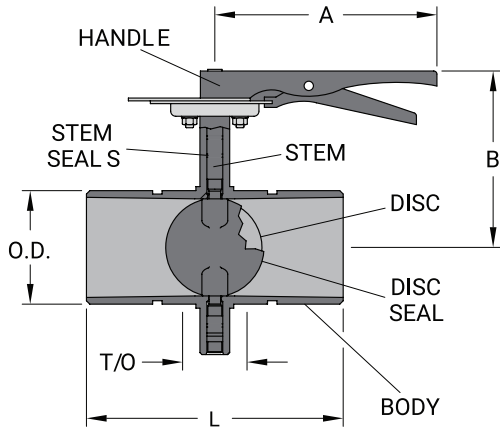

Valve Size	O.D.	Dimensions				Approx. Wt. Ea.
		A	B	L	T/O	
In./mm	In./mm	In./mm	In./mm	In./mm	In./mm	Lbs./Kg
2	2.375	7.95	5.16	7.50	2.40	8.8
50	60.3	202.0	131.0	191.1	61.0	4.0
3	3.500	7.95	5.75	9.18	2.17	17.6
80	88.9	202.0	146.0	233.2	55.1	8.0
4	4.500	7.95	7.05	10.18	2.08	26.4
100	114.3	202.0	179.0	258.6	52.8	12.0
6	6.625	10.28	8.39	10.41	2.31	50.6
150	168.3	261.0	213.0	264.6	58.7	23.0
8	8.625	12.40	9.37	10.96	2.00	74.8
200	219.1	314.9	238.0	278.4	50.8	34.0

10" and 12" (250 and 300mm) are available upon request. Contact ASC Engineered Solutions Sales Representative.

- Introduction
- Couplings
- Outlets
- Fittings
- Valves & Accessories
- High Pressure
- CTS Copper System
- D-Electric Nipples
- Plan-End Fittings
- HDPE Couplings
- Sock-It® Fittings
- Stainless Steel Method
- Roll Groovers
- Installation & Assembly
- Special Coatings
- Design Services
- Technical Data
- Master Format 3 Part Specs.
- Pictorial Index

Ball-Valves Series 7500



The Series 7500 grooved-end ball valve line consists of a 2" to 6", two piece design, and is available in configurations to address a broad spectrum of application requirements.

The Series 7500 has generous factors of safety for pressure retention and stem torsional strength. In addition, it has a blow-out proof stem design, low operating torque, and high C_v.

The Series 7500 is compliant with NACE MR01-75 when stainless steel trim is specified.

Grooved ends conform to the requirements of AWWA C606 for steel pipe.

For special configurations, contact your ASC Engineered Solutions representative.

For stainless steel, see the stainless steel section.

Pressure-Rating: 800 psig CWP (55 bar) in ASTM A 395 Ductile Iron

Material Specifications

Ductile Iron/Stainless Steel

Body

Ductile Iron ASTM A 395

Endplate

Ductile Iron ASTM A 395

Ball

Stainless Steel 316 or 304

Stem

316 Stainless Steel

Thrust Washer

RTFE

Stem Seal

Flouroelastomer

Retaining Ring

Carbon Steel

Handle

Carbon Steel Zinc Plated

Handle Nut

300 Series Stainless Steel

Seat

RTFE

Body Seal

Viton

Lock Plate

300 Series Stainless Steel

Ball-Valves Series 7500

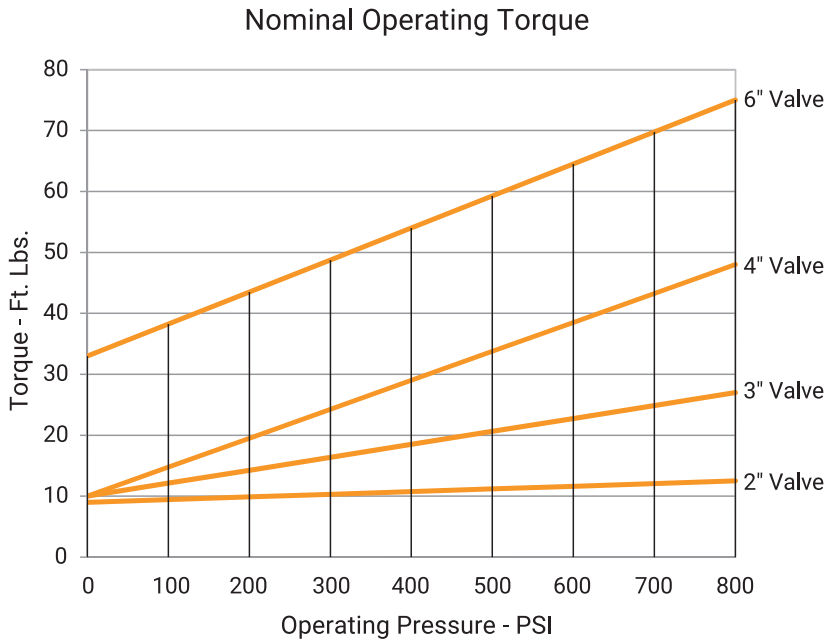

The nominal torque values are for water and lubricating service only.
 For dry gasses an additional multiplier of 2 should be applied to the nominal values.
 Additional torque of up to 3 times the nominal value may be required to break the ball loose if the valve is not frequently operated.

Series 7500 Ball Valves (Ordering Information)

Sample Part Number	4"	G	I -	75	4	2 -	2
4" GI-7512-2 -->	Size	Configuration	Body/End Material	Series	Ball and Stem Material	Seat Material	Operator
	2" - 6"	G - 2 Way Grooved End	I - Ductile Iron ASTM A395	75 - 7500	4 - 304 Stainless Steel (2" - 4") 6 - 316 Stainless Steel	2 - RTFE / Fluoroelastomer	2 - 2 Position Locking Handle 3 - Bare Stem (6" only) M - Mining Handle (4" & 6" only)

Ball-Valves Series 7500

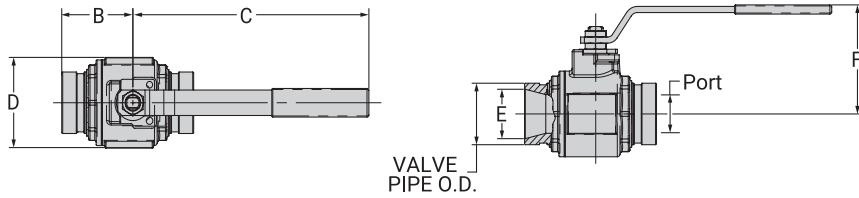

7500 Ball Valve

Size ANSI	O.D.	Nominal Dimensions							Cv	Approx. Wt. Ea.
		A	B	C	D	E	F	Port		
In./DN(mm)	In./mm	In./mm	In./mm	In./mm	In./mm	In./mm	In./mm	In./mm	Lbs./Kg	
2	2.375	5½	2 ³¹ / ₃₂	9 ⁵⁵ / ₆₄	3½	1 ⁵⁹ / ₆₄	4 ¹⁵ / ₆₄	1½	170	7.5
50	60.3	140	75	250	89	49	107	38		3.4
3	3.500	6 ⁹ / ₁₆	3 ³⁷ / ₆₄	12 ⁵ / ₈	5 ⁵ / ₆₄	2 ⁵⁷ / ₆₄	5 ³¹ / ₆₄	2½	425	18.0
80	88.9	167	91	321	129	74	139	64		8.2
4	4.500	8¼	4 ¹¹ / ₆₄	15 ¹ / ₆₄	5 ²⁹ / ₃₂	¾	5 ¹⁵ / ₁₆	3	600	34.0
100	114.3	210	106	382	150	95	151	76		15.5
6*	6.625	10 ⁷ / ₆₄	5 ¹ / ₁₆	15 ¹ / ₆₄	7 ³³ / ₆₄	5 ⁶³ / ₆₄	7 ¹³ / ₃₂	4	850	67.0
150	168.3	257	129	382	191	152	188	102		30.5

*6" sizes come bare stem only. 2 position locking handle sold separately.

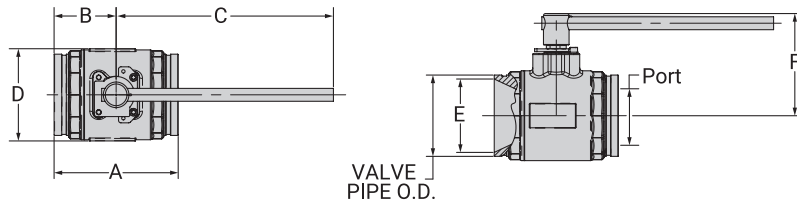

7500 Ball Valve With Mining Handle

Size ANSI	O.D.	Nominal Dimensions							Cv	Approx. Wt. Ea.
		A	B	C	D	E	F	Port		
In./DN(mm)	In./mm	In./mm	In./mm	In./mm	In./mm	In./mm	In./mm	In./mm	Lbs./Kg	
4*	4.500	8¼	4 ¹¹ / ₆₄	17 ²³ / ₃₂	5 ²⁹ / ₃₂	¾	6 ⁵⁵ / ₆₄	3	600	35.0
100	114.3	210	106	450	150	95	174	76		15.9
6*	6.625	10 ⁷ / ₆₄	5 ¹ / ₁₆	17 ²³ / ₃₂	7 ³³ / ₆₄	5 ⁶³ / ₆₄	8 ²¹ / ₆₄	4	850	68.0
150	168.3	257	129	450	191	152	212	102		30.9

*Mining handle sold separately.

Ball-Valves Series 7500

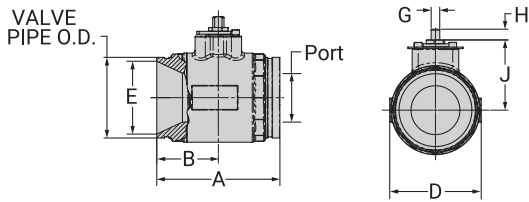

7500 Ball Valve With Bare Stem

Size ANSI	O.D.	Nominal Dimensions								Cv	Approx. Wt. Ea.
		A	B	D	E	G	H	I	Port		
In./DN(mm)	In./mm	In./mm	In./mm	In./mm	In./mm	In./mm	In./mm	In./mm	In./mm	In./mm	Lbs./Kg
6	6.625	10 ⁷ / ₆₄	5 ¹ / ₁₆	7 ³³ / ₆₄	5 ⁶³ / ₆₄	4 ⁵ / ₆₄	7 ⁷ / ₈	5 ⁴⁹ / ₆₄	4	850	66.0
150	168.3	257	129	191	152	18	23	147	102		30.0

Standard option, handle sold separately.

- Introduction
- Couplings
- Outlets
- Fittings
- Valves & Accessories
- High Pressure
- CTS Copper System
- DI-Electric Nipples
- Plain-End Fittings
- HDPE Couplings
- Sock-It® Fittings
- Stainless Steel Method
- Roll Groovers
- Installation & Assembly
- Special Coatings
- Design Services
- Technical Data
- Master Format 3 Part Specs.
- Pictorial Index

Grooved End Ball Valve with Lever Handle and Gear Operator Model BV835



The Model BV835 is a ductile iron, grooved end, regular port, two-piece ball valve that provides for efficient control of fluid in piping systems. The Model BV835 is designed and tested in conformance with MSS SP-110 and MSS SP-72. Flow may be from either direction, and the valves may be positioned in any orientation. The valves are furnished with grooved ends for use with Gruvlok grooved couplings. The handle is provided with a device for padlocking in either the open or closed position. The mounting pad is made to ISO 5211 to allow for mounting of power actuators.

Maximum Working Pressure: 1,000 psi (68.9 bar) 2" – 3" (50 – 80mm)
800 psi (55.1 bar) 4" – 6" (100 – 150mm)

Material Specifications

Body

Ductile iron conforming to ASTM A536, Gr. 65-45-12

Body Coating

Black enamel

Body Seal

PTFE

Ball

Type 304 Stainless Steel

Ball Seat

2" – 4" – Glass-filled TFE, 6" – Carbon-filled TFE

Stem

Carbon steel, nickle-plated, Optional:
Type 304 Stainless Steel

Stem O-Ring

Fluroelastomer

Stem Seal

PTFE

Lever Handle

- 2" – 3" (50 – 80mm): Carbon Steel, Zinc Plated with PVC Plastic
- 4" – 6" (100 – 150mm): Ductile Iron and Carbon Steel

Bracket & Extension Sleeve

Ductile Iron conforming to ASTM A536, Grade 65-45-12 and/or ASTM A395, Grade 65-45-15

Model BV835 Ball Valve Nominal Pressure Loss VS Flow

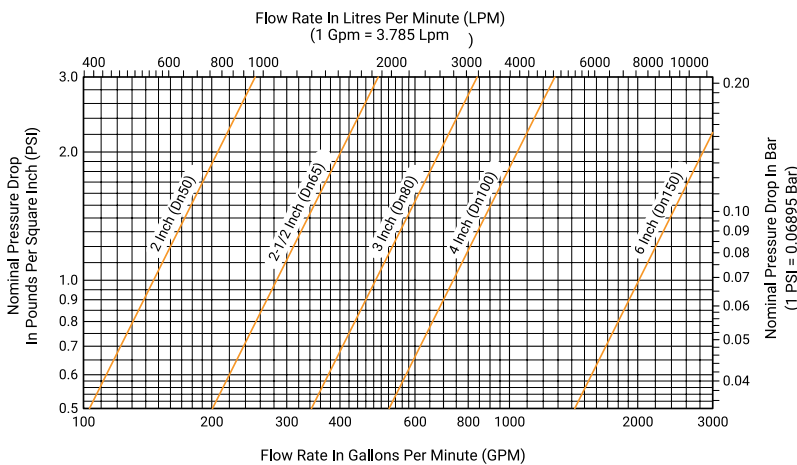

Grooved End Ball Valve with Lever Handle and Gear Operator Model BV835

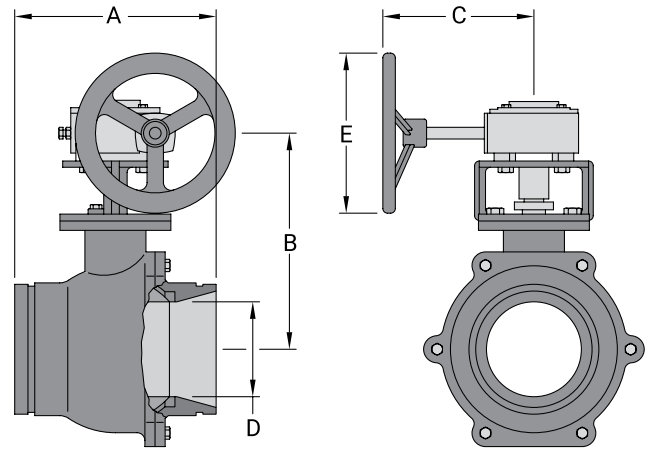
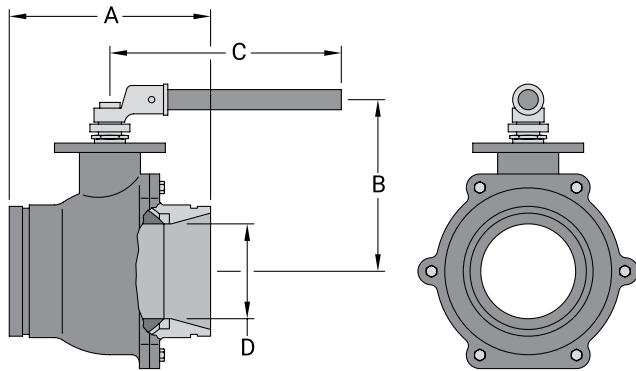

BV835 Ball Valve with Lever Handle

Valve Size	O.D.	Operating Torque	Dimensions				Approx. Wt. Ea.
			A	B	C	D	
2	2.375	150	5.50	3.75	7.00	1.50	6.4
50	60.3	17	140.0	95.0	178.0	38.1	2.9
2½	2.875	186	6.25	5.20	10.43	2.00	10.6
65	73	21	159.0	132.0	265.0	51.0	4.8
3	3.500	248	6.56	5.63	10.43	2.50	13.4
80	88.9	28	167.0	143.0	265.0	63.5	6.1
4	4.500	398	9.45	5.35	23.6	3.50	60.0
100	114.3	45	240.0	135.8	600.0	90.0	27.2
6	6.625	531	10.15	8.68	23.6	4.92	79.2
150	168.3	60	258.0	220.5	600.0	125.0	36.0

BV835 Ball Valve with Gear Operator

Valve Size	O.D.	Dimensions					Approx. Wt. Ea.
		A	B	C	D	E	
2	2.375	5.50	5.38	8.00	1.50	6.00	18.0
50	60,3	140,0	137,0	203,2	38,1	152,4	8,0
2½	2.875	6.25	5.68	8.00	2.00	6.00	22.0
65	73,0	159,0	144,2	203,2	51,0	152,4	10,0
3	3.500	6.56	7.16	8.00	2.50	6.00	31.0
80	88,9	167,0	182,0	203,2	63,5	152,4	14,0
4	4.500	9.45	8.00	8.00	3.50	6.00	73.0
100	114,3	240,0	203,2	203,2	90,0	152,4	33,0
6	6.625	10.15	10.89	14.00	4.92	12.00	123.4
150	168,3	258,0	277,0	356,0	125,0	305,0	56,0

For the first opening or closing of the valve when the valve is not continuously operated, an additional torque of 2.0 – 2.5 times the listed operating torque is normally required. For information on larger sizes, contact an ASC Engineered Solutions Sales Representative.

For information on larger sizes, contact an ASC Engineered Solutions Sales Representative.

**Model BV835 Ball Valve
Pressure Performance**

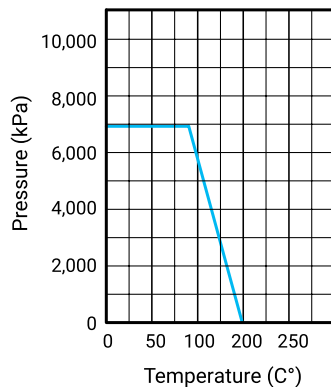

**Check Valve
Fig. 90G**



The Fig. 90G Check Valve is designed for use with Gruvlok couplings, an ASC Engineered Solution, for fast and easy installation on grooved pipe.

Grooved ends conform to the requirements of AWWA C606.

The valve is fitted with a large bonnet closure for ease of field servicing

All Fig. 90G Check Valves are supplied with a 1/2" NPT pipe plug installed in the bonnet cap.

The valve is available with Bonnet Gaskets and Clapper Seals made from EPDM or Nitrile.

Performance

Pressure Rating: 300 psi (20.7 bar) maximum working pressure.

The Fig 90G must be installed with the arrow on the valve body point in the direction of flow through the pipeline. This valve must be installed on horizontal pipelines only.

Material Specifications

Body

Ductile iron conforming to ASTM A 536, Grade 65-45-12, painted.

Bonnet Cap

Ductile iron conforming to ASTM A 536, Grade 65-45-12, painted.

Bonnet Coupling Housing

Ductile iron conforming to ASTM A 536, Grade 65-45-12, painted.

Clapper

Type 316 Stainless Steel

Clapper Pin

Type 316 Stainless Steel

Bushing

PTFE

Clapper Seat/Bumper/Bonnet Gasket

Grade E (EPDM):

-40°F to 230°F (-40°C to 110°C) (Service Temperature Range)

Recommended for water service, dilute acids, alkaline, oil-free air and many chemical services.

Not For Use In Petroleum Services.

Grade T (Nitrile):

-20°F to 180°F (Service Temperature Range) (-29°C to 82°C)

Recommended for petroleum products, air with oil vapors, vegetable oils and mineral oils.

Not For Use In Hot Water Services.

Plugs

Malleable iron conforming to ASTM A 47, galvanized.

Closure Bolts & Nuts

Heat treated, oval-neck track head bolts conforming to ASTM A-183 Grade 2 with a minimum tensile strength of 110,000 psi and heavy hex nuts of carbon steel conforming to ASTM A-563 Grade A or Grade B, or SAE J995 Grade 2. Bolts and nuts are provided zinc electroplated.

Check Valve Fig. 90G

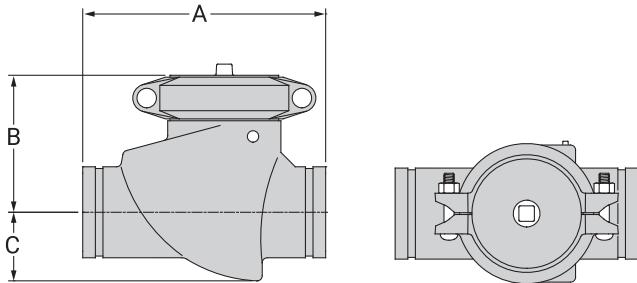

Fig. 90G Check Valve

Nominal Size	O.D.	Nominal Dimensions			Approx. Wt. Ea.
		A	B	C	
In./DN(mm)	In./mm	In./mm	In./mm	In./mm	Lbs./Kg.
2	2.375	9.02	5.12	1.85	11.4
50	60.3	229	30	47	5.2
2½	2.875	9.25	5.34	2.24	21.3
65	73.0	235	136	57	9.7
3	3.500	10.75	5.71	2.76	16.0
80	88.9	273	145	70	7.3
4	4.500	12.01	6.42	3.31	33.3
100	114.3	305	163	84	15.1

C_v Values

Size		Flow Coefficients – C _v Full Open Valve
Nominal Diameter	Actual Outside Diameter	
In./mm	In./mm	
2	2.375	80
50	60.3	–
2½	2.875	134
65	73.0	–
3	3.500	210
80	88.9	–
4	4.500	430
100	114.3	–

C_v values for flow of water are with a full open valve.

Important Note:

The Fig 90G check valve life may be shortened and system damage may occur if check valves are installed too close to a source of unstable flow. Check valves must be installed at a reasonable distance away from pumps, elbows, expanders, reducers or other similar devices. Sound piping practices dictate a minimum of five (5) times the pipe diameter for general use. Distances between three (3) and five (5) diameters are allowable provided the flow velocity is less than 8 feet per second. Distances less than 3 diameters are not recommended.

Flow Characteristics

The chart below expresses the flow of water through a full open valve.

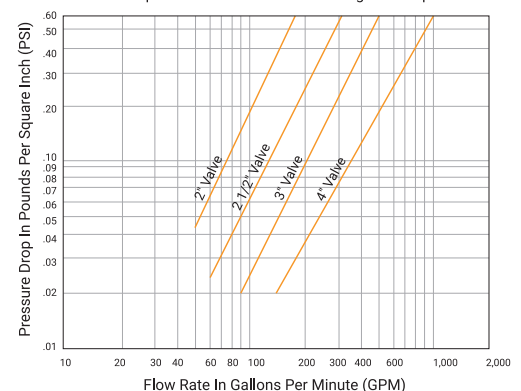

Grooved-End Silent Check Valve Fig. 400G

Available in Sizes
2" thru 10"

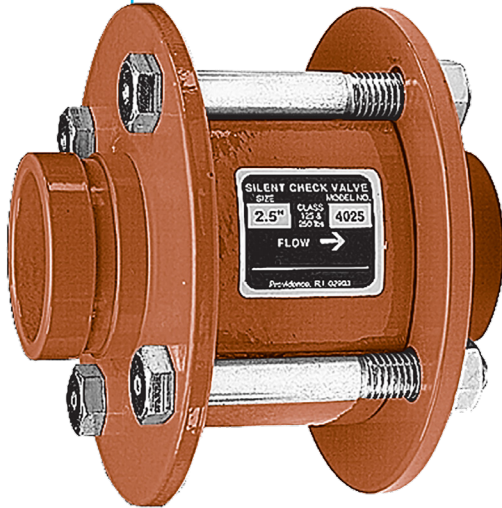

The 400G is a center guided, spring loaded, silent check valve. Designed and engineered for silent operation with low head loss, the valve disc will close prior to the reversal of flow, thereby preventing or minimizing water hammer and damaging shock.

- The 400G can be used in any HVAC, industrial or commercial grooved piping systems.
- The valve is designed for liquid service with any pipe orientation, flow up or down.
- Bronze metal seats are standard, with Stainless Steel or resilient seats available as an option.
- Flow coefficients for this valve are some of the lowest in the industry and are listed for each size on the drawing.

Note: Valve is designed for liquid service only. Install 3 to 4 pipe diameters downstream from pump discharge or elbows to avoid flow turbulence.

Material Specifications

Standard Materials

Cast Iron body ASTM A 48, Class 35
Bronze Disc and Seat ASTM B 584 Alloy 838
Ductile Iron Grooved-Ends ASTM A 395

Optional Trim Materials

Bronze with Nitrile seats
Stainless Steel seats
Stainless with Nitrile seats

- 1. Body:** Cast Iron ASTM A 48, Class 35
- 2. Seat:** Bronze ASTM B 584, Copper Alloy 838
- 3. Plug:** Bronze ASTM B 584, Copper Alloy 838
- 4. Spring:** Stainless Steel T304, ASTM A 313
- 5. Bushing:** Bronze ASTM B 584, Copper Alloy 836
- 6. Screws:** Stainless Steel T304, ASTM A 276
- 7. Grooved-End:** Ductile Iron ASTM A 395
- 8. Gasket:** Non Asbestos
- 9. Bolts:** Carbon Steel

For gasket grade recommendations see the Technical Data section

Other materials and resilient seats are available. contact your Sales representative.

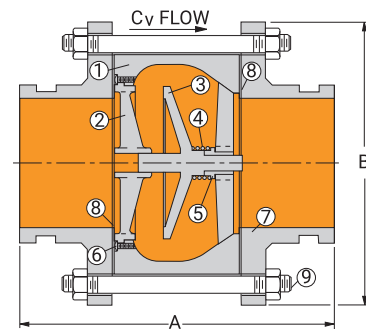

Grooved-End Silent Check Valve Fig. 400G

Available in Sizes 2" thru 10"

Fig. 400G Grooved-End Silent Check Valve

Valve Size	O.D.	Model	A	B	C _v Flow *	Approx Wt. Each
In./mm	In./mm	Number	In./mm	In./mm		Lbs./Kg
2 50	2.375 60.3	402G	6 152	6 152	66 1,676	12 5.4
2½ 65	2.875 73.0	4025G	6¼ 159	7 178	88 2,235	15 6.8
3 80	3.500 88.9	403G	6¾ 164	7½ 191	130 3,302	20 9.1
4 100	4.500 114.3	404G	8⅞ 206	9 229	228 5,791	36 16.3
5 125	5.563 141.3	405G	11¼ 286	10 254	350 8,890	50 22.7
6 150	6.625 168.3	406G	12¼ 311	11 279	520 13,208	68 30.8
8 200	8.625 219.1	408G	13¾ 349	13½ 343	900 22,860	140 63.5
10 250	10.75 273.1	410G	16 406	16 406	1,450 36,830	198 89.8

*Flow coefficient is the number of U.S. gallons/minute of 60° F (16° C) water that will flow through a valve with 1 psi (0.069 bar) of pressure drop across the valve.

Max. Non-Shock Working PSI 125# ANSI B16.1 Flange Rating

Size	Temperature	
	150°F 65°C	200°F 90°C
2" - 10"	200 PSI 13.8 bar	190 PSI 13.1 bar

Check Valves for use in Grooved-End Piping Systems Series 7800

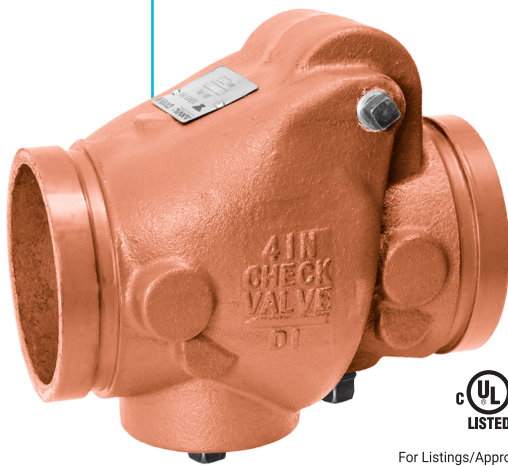

For Listings/Approval Details and Limitations, visit our website at www.asc-es.com or contact an ASC Engineered Solutions Sales Representative.

The Gruvlok Series 7800 Check Valve is a compact, cost effective valve offering low pressure-drop, non-slam performance. The Series 7800 Check Valve assembly is lighter and faster to install, and costs less than flanged and wafer valve assemblies.

In the fully open position the Series 7800 swing clapper is held tightly against the valve body, out of the flow stream, to provide maximum flow area and prevention of clapper flutter. The clapper design produces quick, non-slam closure before flow reversal can occur, while meeting FM requirements for an anti-water hammer valve rating.

Each valve is hydrostatically tested for leak tightness to 500 PSI. The clapperseat design permits leak free sealing of back pressures in service conditions ranging from 300 PSI (20.7 bar) to as low as 1 PSI (0.07 bar) (head pressure: 28").

Performance

Pressure Rating: Commercial Applications - Sizes 2" thru 12" inclusive, 300 psi (20.7 bar) maximum working pressure.

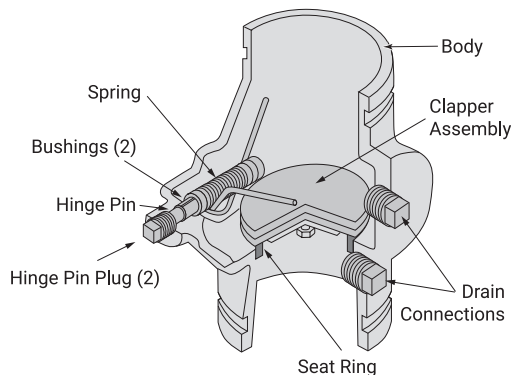

Material Specifications

Body

Ductile iron conforming to ASTM A 536, Grade 65-45-12

Coating

Rust inhibiting paint on exterior and interior - color: orange enamel

Clapper

2" - 5" Type 304 or 302 stainless steel to ASTM A 167

6" - 12" Ductile iron conforming to ASTM A 536, Grade 65-45-12

Clapper Facing

Grade E EPDM: -40° to 230°F (-40° to 110°C)
Service Temperature Range

Recommended for water service, dilute acids, alkaline, oil-free air and many chemical services.
Not For Use In Petroleum Services.

Grade T Nitrile: -20° to 180°F (-29° to 80°C)
Service Temperature Range

Recommended for petroleum products, air with oil vapors, vegetable oils and mineral oils.
Not For Use In Hot Water Services.

Seat Ring

Type 304 stainless steel to ASTM A 123, ASTM A 213, ASTM A 312 or ASTM A 269

Spring

Type 302 stainless steel to ASTM A 313

Hinge Pin

Type 304 or 302 stainless steel to ASTM A 580

Hinge Pin Bushings

Sintered bronze to ASTM B 438

Hinge Pin Plugs & Drain Plugs

Cast iron to ASTM A 126 Class A

Check Valves for use in Grooved-End Piping Systems Series 7800

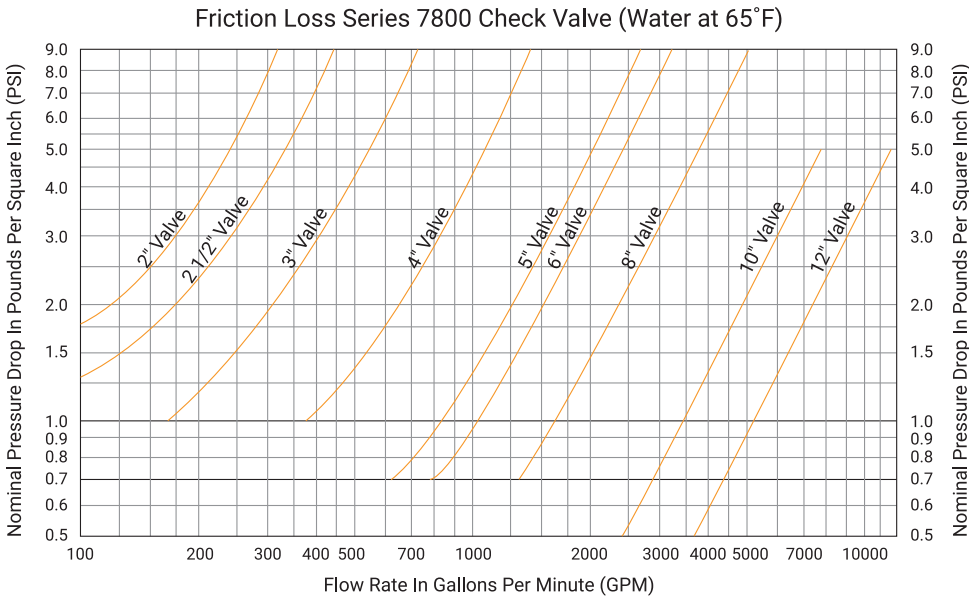

Flow Data - Friction Loss (Ft. of Pipe)

Valve Size	O.D.	C=100			C=120		
		Sch. 10	Sch. 30	Sch. 40	Sch. 10	Sch. 30	Sch. 40
In./mm	In./mm	Ft./m	Ft./m	Ft./m	Ft./m	Ft./m	Ft./m
2	2.375	10	—	8	14	—	11
50	60.3	3.0	—	2.4	4.3	—	3.4
2½	2.875	14	—	10	20	—	15
65	73.0	4.3	—	3.0	6.1	—	4.6
3	3.500	17	—	12	23	—	17
80	88.9	5.2	—	3.7	7.0	—	5.2
4	4.500	17	—	13	23	—	18
100	114.3	5.2	—	4.0	7.0	—	5.5
5	5.563	14	—	11	20	—	15
125	141.3	4.3	—	3.4	6.1	—	4.6
6	6.625	23	—	19	33	—	26
150	168.3	7.0	—	5.8	10.1	—	7.9
8	8.625	35	32	30	50	45	43
200	219.1	10.7	9.8	9.1	15.2	13.7	13.1
10	10.750	28	25	24	40	36	34
250	273.1	8.5	7.6	7.3	12.2	11.0	10.4
12	12.750	31	28	26	44	39	37
300	323.9	9.4	8.5	7.9	13.4	11.9	11.3

Flow Data

The approximate friction losses, based on the Hazen and Williams formula, expressed in equivalent length of pipe is given below.

The friction losses have been calculated on the basis of flow rates typically used with each size valve.

Important Note:

Check valve life may be shortened and system damage may occur if check valves are installed too close to a source of unstable flow. Check valves must be installed at a reasonable distance away from pumps, elbows, expanders, reducers or other similar devices. Sound piping practices dictate a minimum of five (5) times the pipe diameter for general use. Distances between three (3) and five (5) diameters are allowable provided the flow velocity is less than 8 feet per second. Distances less than 3 diameters are not recommended.

This valve may be installed vertically or horizontally. In a horizontal installation, the hinge pin is to be located on top.

Not for use in copper systems.

Check Valves for use in Grooved-End Piping Systems Series 7800

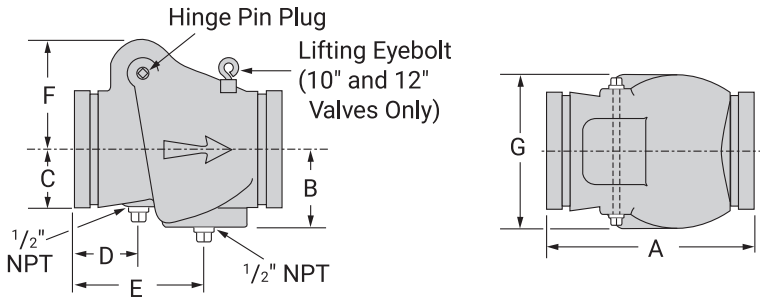

Fig. 7800 Check Valve

Valve Size	O.D.	Nominal Dimensions							Approx. Wt. Ea.
		A	B	C	D	E	F	G	
in./mm	in./mm	Ft./m	Ft./m	Ft./m	Ft./m	Ft./m	Ft./m	Ft./m	Ft./m
2	2.375	6 ³ / ₄	2 ³ / ₈	1 ⁷ / ₁₆	1 ³ / ₄	4 ¹ / ₂	3 ³ / ₁₆	4 ³ / ₈	7.5
50	60.3	171	60	36	44	114	81	111	3.4
2½	2.875	7¼	2 ⁷ / ₁₆	1 ⁹ / ₁₆	1¾	3 ¹³ / ₁₆	3 ⁵ / ₈	4½	10.5
65	73.0	184	61	39	44	96	92	114	4.8
3	3.500	7¾	2 ⁵ / ₈	2	1 ⁹ / ₁₆	4 ¹ / ₁₆	3 ¹¹ / ₁₆	4 ¹⁵ / ₁₆	11.5
80	88.9	197	67	51	46	103	93	125	5.2
4	4.500	8 ¹ / ₈	3 ¹ / ₈	2¼	2½	5 ¹ / ₁₆	4¼	6	13.5
100	114.3	206	79	57	64	128	108	152	6.1
5	5.563	9¾	3½	2¾	2 ⁷ / ₁₆	5 ¹³ / ₁₆	4 ⁵ / ₈	6¾	19.0
125	141.3	248	89	70	61	147	117	171	8.6
6	6.625	12¾	4¼	3 ⁵ / ₁₆	3 ¹ / ₈	6¼	6¾	8½	33.5
150	168.3	324	108	84	79	159	171	216	15.2
8	8.625	14¾	5 ¹ / ₁₆	3 ¹⁵ / ₁₆	4	5 ¹⁵ / ₁₆	8	10¼	59.0
200	219.1	365	128	100	102	150	203	260	26.8
10	10.750	18	6 ⁵ / ₁₆	4 ¹⁵ / ₁₆	4 ⁹ / ₁₆	6 ⁷ / ₈	9 ³ / ₁₆	12 ¹¹ / ₁₆	130.0
250	273.1	457	160	125	115	175	233	322	59.0
12	12.750	21	7 ⁵ / ₁₆	6	5 ¹ / ₁₆	7¼	10 ³ / ₈	14¾	183.0
300	323.9	533	185	152	128	184	264	375	83.0

Series 7800 Check Valves (Ordering Information)

Sample Part Number 4" 7811-->	4"	78	1	1	X
	Size	Series	Clapper Facing Material	Body Finish	Special Configuration
	2" - 12"	78 - 7800	1 - EPDM (Std) 2 - Nitrile (Std)	1 - Painted (Std)	2 - Other *

*Contact an ASC Engineered Solutions representative for more information.

Dual Disc Check Valve Fig. CV890



The Fig. CV890 Dual Disc Check Valve is a grooved end, dual disc check valve used for pipelines to convey water and other fluids with a rated working pressure up to 300 psi (20.7 bar). This Dual Disc Check Valve is available in sizes from 14 inches (350 mm) to 24 inches (600 mm).

The Fig. CV890 Dual Disc Check Valve features a fully lined rubber body, spring-loaded 304 stainless steel disc and shafts. The Dual Disc Check Valve can be installed in a horizontal or vertical position (upward flow only). A lifting lug is provided with the assembly for ease of handling. The face to face dimensions conforms to API 594 Class 150 and grooved end dimensions to ANSI/AWWA C606. The seat and shell pressure tests conform to MSS SP-136 or higher.

The Fig. CV890 Dual Disc Check Valve is lighter than conventional swing check valves and is easier to install, utilizing only two grooved couplings. It is more economical than wafer or lugged valves. The Dual Disc Check Valve design produces less water hammer than a single disc valve. The spring-loaded disc design provides for positive closing. The fully lined rubber body and soft seat reduces noise and maintenance.

Maximum Working Pressure: 300 psi (20.7 bar) @ 100°F (38°C)

Material Specifications

Body

Ductile iron conforming to ASTM A536, Gr. 65-45-12

Body Lining

- Grade Nitrile – For service temperatures from –20°F to 230°F (–29°C to 110°C). Recommended for petroleum products, mineral oils, vegetable oils, aromatic hydrocarbons, acids and water $\leq 150^{\circ}\text{F}$ (+65°C).

Note: Not recommended for use in hot water services.

- Grade EPDM – For service temperatures from –30°F to 230°F (–34°C to 110°C). For general service. Recommended for water service, dilute acids, alkalies, oil-free air and many chemical services.

Note: Not recommended for use in petroleum services.

Disc

Stainless Steel Type 304

Disc Shafts

Stainless Steel Type 304

Spring

Stainless Steel Type 304

Dual Disc Check Valve Fig. CV890

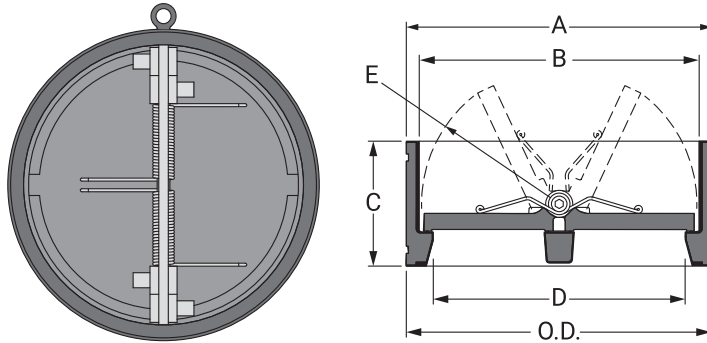

Valve Size	O.D.	Dimensions					Approx. Wt. Ea.
		A	B	C	D	E	
In./mm	In./mm	In./mm	In./mm	In./mm	In./mm	In./mm	Lbs./Kg
14	14.00	14.49	12.96	7.25	11.14	6.06	101
350	355.6	368	329	184	283	154	46
16	16.00	16.14	14.13	7.50	12.20	6.81	119
400	406.4	410	359	191	310	173	54
18	18.00	18.15	16.42	8.000	14.33	8.00	169
450	457.2	461	417	203	364	203	77
20	20.00	20.04	18.11	8.625	16.06	8.80	211
500	508.0	509	460	219	408	226	96
24	24.00	24.00	22.13	8.750	18.00	9.80	131
600	609.6	610	562	222	457	249	288

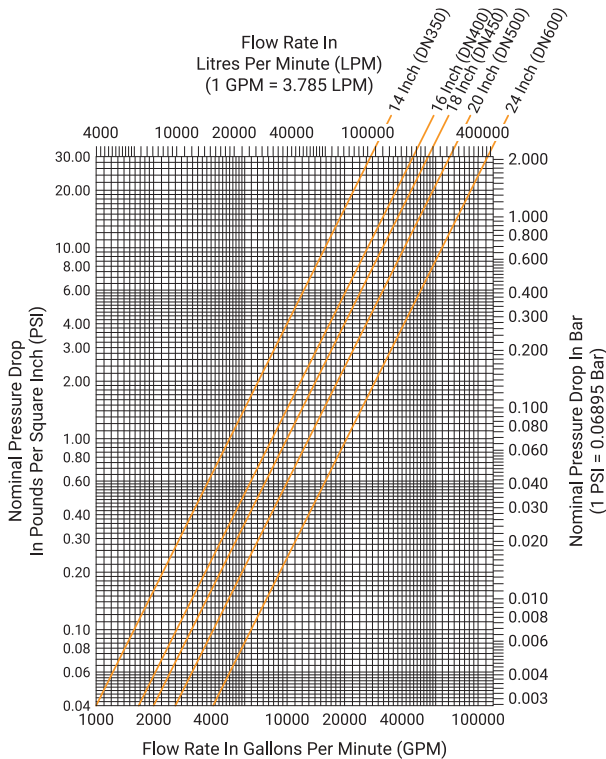

Straight DZR Brass Automatic Balancing Valve Fig. Anvil ABV-9900V Series

Fig. 9907V
Mounted
Test Points

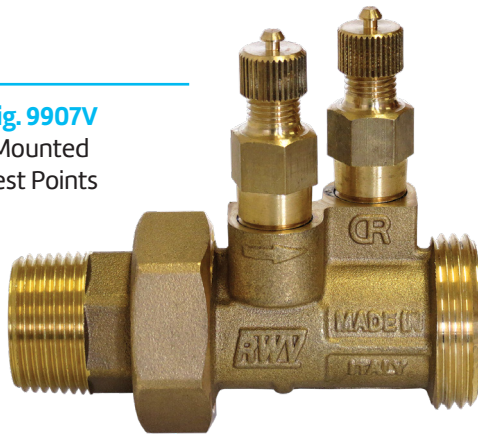

Fig. 9900V
Cartridge



Material Specifications

1. **Union Nut:** Brass ASTM B283 C37700
2. **Union¹:** DZR Brass UNS C35330
3. **Union O-Ring:** EPDM Perox
4. **Spring:** Stainless Steel AISI 302
5. **Body:** DZR Brass UNS C35330
6. **Cartridge O-Ring:** EPDM Perox
7. **Shaped Opening:** Stainless Steel
8. **Cartridge Body:** DZR Brass UNS C35330
9. **Cartridge Spring:** Stainless Steel AISI 302
10. **Test Point/Plug:** DZR Brass² UNS C35330

¹ In two pieces for ¾" -L and 2" F threaded version

² Plug with copper gaskets. Test points with EPDM Perox gaskets and polypropylene ties.

Threaded F/F (ASME B1.20.1 - NPT) or solder joint (ASME B16.22) union ends. Wide range of flows available (see cartridge section). 300 WOG (Maximum 300 psi up to 160°F. Maximum 150psi at 260°F.)

Available on following versions:

ABV-T-9907 (NPT Union F/F Ends) with mounted test points

ABV-S-9909 (CxC Union Ends) with mounted test points

Working Conditions:

- Water (15°F to 260°F)
(Glycolic-Ethylene and glycolic-propylene mixtures up to 50% may be used.) below 32°F only for water with added anti-freezing fluids over 212°F only for water with added anti-boiling fluid
- Flow Range
Valves up to ¾"L: 0.32GPM - 3.17GPM
¾" and 1" valves: 2.06GPM - 15.1 GPM
1¼", 1½", and 2" valves: 4.91GPM - 41.2GPM
2"H and 2½" valves: 25.4GPM - 105GPM
- Working ΔP depending on selected cartridge

For additional information on Gruvlok bag and tag coil kit service, contact an ASC Engineered Solutions Representative.

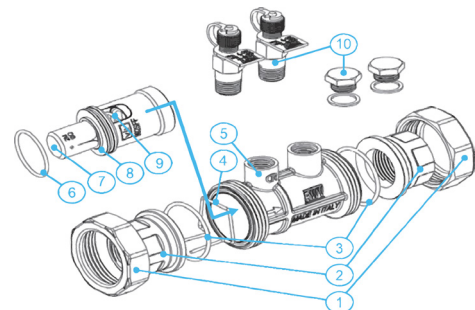

Straight DZR Brass Automatic Balancing Valve
Fig. Anvil ABV-9900V Series

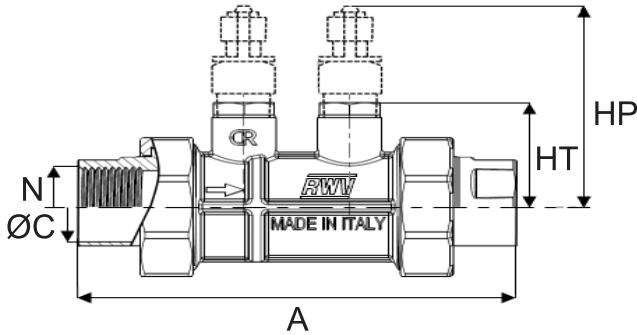

Straight DZR Brass Automatic Balancing Valve

Valve Size	N	ØC ¹	A ²	HT/HP	Cv ³	Approx. Wt. Each	
						Valve	Cartridge
In./mm	In./mm	In./mm	In./mm	In./mm	GPM	Lbs./Kg	Lbs./Kg
½	½	0.627-0.631	3.78/3.41	1.08/2.34	14	0.83/0.73	0.10
15	15	15.93-16.03	96.0/86.6	27.4/59.4	–	0.38/0.33	0.05
¾L	¾	0.877-0.881	4.65/3.96	1.08/2.34	14	0.99/0.76	0.10
20	20	22.28-22.38	118.1/100.6	27.4/59.4	–	0.45/0.34	0.05
¾	¾	0.877-0.881	4.47/4.51	1.34/2.60	21	1.16/1.03	0.21
20	20	22.28-22.38	113.5/114.6	34.0/66.0	–	0.53/0.47	0.10
1	1	1.128-1.131	4.72/4.74	1.34/2.60	27	1.45/1.21	0.21
25	25	28.65-28.73	119.9/120.0	34.0/66.0	–	0.66/0.55	0.10
1¼	1¼	1.378-1.381	6.27/6.82	1.61/2.87	97	2.78/3.17	0.56
32	32	35.00-35.08	159.3/173.2	40.9/72.9	–	1.26/1.44	0.25
1½	1½	1.628-1.632	6.27/7.06	1.61/2.87	97	3.34/3.18	0.56
40	40	41.35-41.45	159.3/179.3	40.9/72.9	–	1.52/1.44	0.25
2	2	2.128-2.132	8.20/7.56	1.61/2.87	94	4.55/3.28	0.56
50	50	54.05-54.15	208.3/192.0	40.9/72.9	–	2.06/1.49	0.25
2H	2	2.128-2.132	9.16/9.82	2.36/3.62	189	7.83/7.45	3.01
50	50	54.05-54.15	232.7/249.4	59.9/91.9	–	3.55/3.38	1.37
2½	2½	2.628-2.632	9.50/10.01	2.36/3.62	228	8.31/7.47	3.01
65	65	66.75-66.88	241.3/254.3	59.9/91.9	–	3.77/3.39	1.37

¹ Tolerance field
² Threaded ends / soldering ends
³ For valve body without cartridge
⁴ Threaded ends / soldering ends, over with test points +0.10lb

Straight DZR Brass Automatic Balancing Valve Fig. Anvil ABV-9900V Series

Cartridges

Cartridges are available in different ranges of working differential pressure. The minimum and maximum working ΔP therefore depends on the specific cartridge model.

A numeric code is marked on the cartridge body univocally identifying it (example for KRR992215.1880).

If installed, the test points allow to verify if the valve is actually working within the range suitable for the selected cartridge.

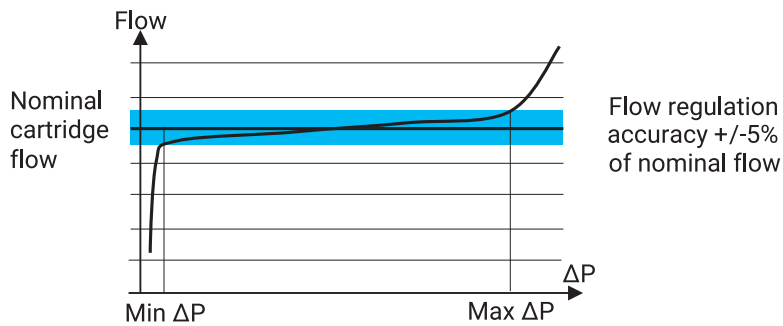

For additional information on Gruvlok bag and tag coil kit service, contact an ASC Engineered Solutions Representative.

- Introduction
- Couplings
- Outlets
- Fittings
- Valves & Accessories**
- High Pressure
- CTS Copper System
- D-Electric Nipples
- Plain-End Fittings
- HDPE Couplings
- Sock-It® Fittings
- Stainless Steel Method
- Roll Groovers
- Installation & Assembly
- Special Coatings
- Design Services
- Technical Data
- Master Format 3 Part Specs.
- Pictorial Index

Straight DZR Brass Automatic Balancing Valve Fig. Anvil ABV-9900V Series

Cartridges

MINI: for ½" and ¾" L Valves

RWV Code	Flow	Range ΔP
	GPM	psi
-		
KRR991202.1880	0.32	2.2-25
KRR991203.1880	0.48	2.3-32
KRR991204.1880	0.63	2.3-32
KRR991205.1880	0.79	2.3-32
KRR991206.1880	0.95	2.3-32
KRR991207.1880	1.11	2.3-32
KRR991208.1880	1.27	2.3-32
KRR991209.1880	1.43	2.3-32
KRR991210.1880	1.59	2.3-32
KRR991211.1880	1.74	2.5-32
KRR991212.1880	1.90	2.5-32
KRR991213.1880	2.06	2.5-32
KRR991214.1880	2.22	2.5-32
KRR991215.1880	2.38	2.5-32
KRR991216.1880	2.54	2.5-32
KRR991218.1880	2.85	2.6-32
KRR991220.1880	3.17	2.8-32

SMALL : for ¾" and 1" Valves Standard Range

RWV Code	Flow	Range ΔP
	GPM	psi
-		
KRR992213.1880	2.06	2.5-35
KRR992215.1880	2.38	2.5-35
KRR992217.1880	2.69	2.5-35
KRR992219.1880	3.01	2.5-35
KRR992221.1880	3.33	2.6-35
KRR992224.1880	3.80	2.6-35
KRR992227.1880	4.28	2.6-35
KRR992230.1880	4.76	2.6-35
KRR992233.1880	5.23	2.6-35
KRR992236.1880	5.71	2.6-35
KRR992240.1880	6.34	2.6-35
KRR992245.1880	7.13	2.8-35
KRR992250.1880	7.93	2.8-35
KRR992255.1880	8.72	3.0-35
KRR992260.1880	9.51	3.2-35
KRR992266.1880	10.5	3.5-35
KRR992272.1880	11.4	3.5-35

SMALL: for ¾" and 1" Valves HP Range

RWV Code	Flow	Range ΔP
	GPM	psi
-		
KRR992318.1880	2.85	4.2-64
KRR992320.1880	3.17	4.6-64
KRR992323.1880	3.65	4.8-64
KRR992327.1880	3.96	4.8-64
KRR992329.1880	4.60	4.8-64
KRR992332.1880	5.07	4.8-64
KRR992336.1880	5.71	4.8-64
KRR992340.1880	6.34	4.8-64
KRR992345.1880	7.13	4.8-64
KRR992350.1880	7.93	4.8-64
KRR992355.1880	8.72	4.9-64
KRR992361.1880	9.67	5.2-64
KRR992368.1880	10.80	5.2-64
KRR992375.1880	11.90	5.2-64
KRR992380.1880	12.70	5.2-64
KRR992386.1880	13.60	5.8-64
KRR992395.1880	15.10	5.8-64

MEDIUM: for 1 ½", 1 ½" and 2" Valves Standard Range

RWV Code	Flow	Range ΔP
	GPM	psi
-		
KRR994231.1880	4.91	1.9-33
KRR994234.1880	5.39	1.9-33
KRR994237.1880	5.86	1.9-33
KRR994240.1880	6.34	2.0-33
KRR994246.1880	7.29	2.0-33
KRR994250.1880	7.93	2.0-33
KRR994255.1880	8.72	2.0-33
KRR994258.1880	9.19	2.0-33
KRR994262.1880	9.83	2.0-33
KRR994267.1880	10.60	2.2-33
KRR994274.1880	11.70	2.2-33
KRR994283.1880	13.20	2.2-33
KRR994290.1880	14.30	2.2-33
KRR994297.1880	15.40	2.2-33
KRR994210.1880	16.60	2.2-33
KRR994212.1880	19.00	2.2-33
KRR994213.1880	20.60	2.3-33
KRR994214.1880	22.80	2.5-33
KRR994216.1880	24.70	2.5-33
KRR994217.1880	26.60	2.6-33
KRR994218.1880	28.50	2.8-33
KRR994220.1880	31.10	2.8-33

MEDIUM: for 1 ¼", 1 ½" and 2" Valves HP Range

RWV Code	Flow	Range ΔP
	GPM	psi
-		
KRR994341.1880	6.50	3.8-61
KRR994346.1880	7.29	3.8-61
KRR994351.1880	8.08	3.8-61
KRR994355.1880	8.72	3.9-61
KRR994362.1880	9.83	3.9-61
KRR994368.1880	10.80	3.9-61
KRR994374.1880	11.70	3.9-61
KRR994379.1880	12.50	3.9-61
KRR994383.1880	13.20	3.9-61
KRR994391.1880	14.40	4.1-61
KRR994310.1880	15.90	4.1-61
KRR994311.1880	17.60	4.1-61
KRR994312.1880	19.00	4.2-61
KRR994313.1880	20.60	4.2-61
KRR994314.1880	22.00	4.2-61
KRR994316.1880	26.00	4.4-61
KRR994318.1880	27.70	4.5-61
KRR994319.1880	30.10	4.5-61
KRR994321.1880	32.70	4.6-61
KRR994322.1880	35.40	4.9-61
KRR994324.1880	38.00	5.1-61
KRR994326.1880	41.20	5.5-61

LARGE: for 2"H and 2 ½"L Valves

RWV Code	Flow	Range ΔP
	GPM	psi
-		
KRR996216.1880	25.4	2.0-33
KRR996218.1880	28.5	2.0-33
KRR996220.1880	31.7	2.0-33
KRR996222.1880	34.9	2.2-33
KRR996224.1880	38.0	2.2-33
KRR996227.1880	42.8	2.2-33
KRR996230.1880	47.6	2.3-33
KRR996233.1880	52.3	2.3-33
KRR996236.1880	57.1	2.3-33
KRR996240.1880	63.4	2.5-33
KRR996245.1880	71.3	2.5-33
KRR996250.1880	79.3	2.8-33
KRR996255.1880	87.2	2.8-33
KRR996260.1880	95.1	3.0-33
KRR996266.1880	105.0	3.0-33

Fixed Orifice Double Regulating Valve Fig. Anvil MBV-9510 Series



Features

Fixed orifice low lead DZR brass double regulating valve. Intended for HVAC and domestic water use. Threaded F/F (ASME B1.20.1 - NPT) or solder joint ends (ASME B16.22). Design according to BS7350. Tolerance on nominal C_v +3% (test according to BS7350). 300 WOG (Maximum 300psi up to 160°F. Maximum 150psi at 260°F.)

Available on following versions:

- MBV-T-9517, threaded ends, with test points
- MBV-S-9519, solder joint ends, with test points

Working Conditions:

- Water (15°F to 260°F)
below 32°F only for water with added anti-freezing fluid
over 212°F only for water with added anti-boiling fluid

For additional information on Gruvlok bag and tag coil kit service, contact an ASC Engineered Solutions Representative.

Material Specifications

- Venturi Insert:** Low Lead DZR Brass ASTM C27453
- Body:** Low Lead DZR Brass ASTM C27453
- Balancing Cone:** Low Lead DZR Brass ASTM C27453
- Gasket Disc:** PTFE
- Disc¹:** Low Lead DZR Brass ASTM C27453
- Disc O-Ring¹:** EPDM Perox
- Disc Stem:** Low Lead DZR Brass ASTM C27453
- Stem O-Ring:** EPDM Perox
- Union¹:** Low Lead DZR Brass ASTM C27453
- Stem:** Brass ASTM B124 C37700
- Bonnet:** Low Lead DZR Brass ASTM C27453
- Stop Spring Ring:** Spring Steel
- Screw:** Steel
- Handwheel:** ABS (Blue)
- Nut:** Zinc Plated Steel
- Test Point:** DZR Brass² ASTM C35330

¹ Only on 1 1/4", 1 1/2" and 2"

² Test points with EPDM gaskets and polypropylene ties

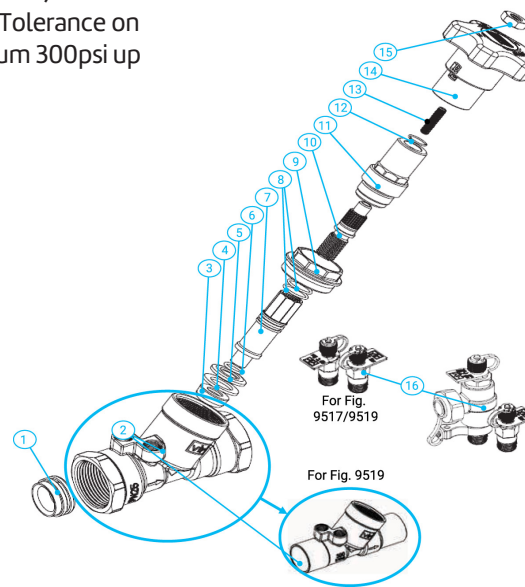

Fixed Orifice Double Regulating Valve Fig. Anvil MBV-9510 Series

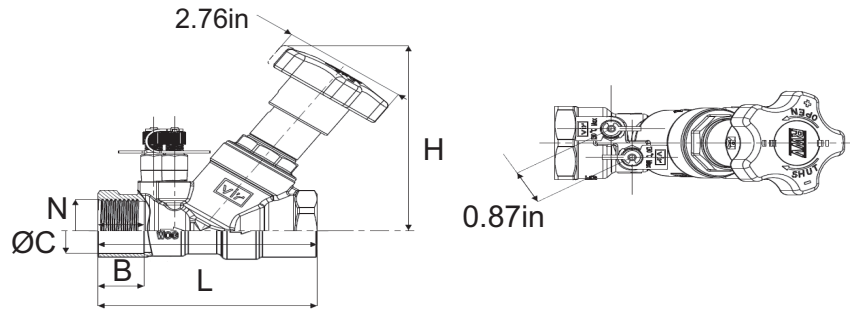

Fixed Orifice Double Regulating Valve

Valve Size	N	ØC ¹	H	L ²	B ²	Approx. Wt. ² Each	Flow Range
In./mm	In./mm	In./mm	In./mm	In./mm	In./mm	Lbs./Kg	GPM
U-½ 15	½- 14 –	0.627-0.631 15.93-16.03	4.06 103.1	3.46/3.74 87.9/95.0	0.71/0.55 18.0/14.0	1.23/1.16 0.56/0.53	0.27-0.71 –
L- ½ 15	½- 14 –	0.627-0.631 15.93-16.03	4.06 103.1	3.46/3.74 87.9/95.0	0.71/0.55 18.0/14.0	1.23/1.16 0.56/0.53	0.49-1.17 –
½ 15	½- 14 –	0.627-0.631 15.93-16.03	4.06 103.1	3.46/3.74 87.9/95.0	0.71/0.55 18.0/14.0	1.23/1.16 0.56/0.53	0.98-2.35 ³ –
¾ 20	¾- 14 –	0.877-0.881 22.28-22.38	4.06 103.1	3.78/4.18 96.0/106.2	0.75/0.76 19.1/19.3	1.43/1.34 0.65/0.61	2.19-5.15 ³ –
1 25	1 - 11.5 –	1.128-1.131 28.65-28.73	4.06 103.1	3.94/4.57 100.1/116.1	0.89/0.92 22.6/23.4	1.73/1.55 0.78/0.70	4.09-9.56 ³ –
1¼ 32	1¼- 11.5 –	1.378-1.381 35.00-35.08	4.06 103.1	4.63/5.28 117.6/134.1	0.98/0.98 24.9/27.9	2.78/2.53 1.26/1.15	8.56-19.81 ³ –
1½ 40	1½- 11.5 –	1.628-1.632 41.35-41.45	4.06 103.1	5.00/5.90 127.0/149.9	0.98/1.10 24.9/27.9	3.50/3.16 1.59/1.43	12.84-29.80 ³ –
2 50	2 - 11.5 –	2.128-2.132 54.05-54.15	4.06 103.1	5.72/6.73 145.3/170.9	1.15/1.35 29.2/34.3	4.80/4.46 2.18/2.02	24.09-55.63 ³ –

¹ Tolerance field

² Threaded ends/soldering ends

³ Dimension with VIR actuators, for more details please consult specific technical sheet ⁴
Suggested flow range applicability (BS7350)

If used with measuring manometers different from those proposed by Anvil-RWV, please verify that sensibility of the measuring device is compatible with indicated minimum.

For additional information on Gruvlok bag and tag coil kit service, contact an ASC Engineered Solutions Representative.

Fixed Orifice Double Regulating Valve Fig. Anvil MBV-9510 Series

Flow Diagram

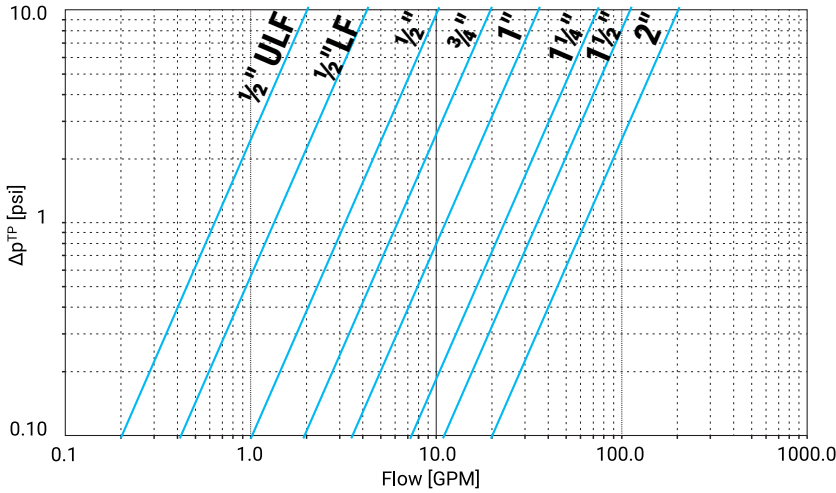

1/2" ULF	C _{vs venturi}	0.64
1/2" LF	C _{vs venturi}	1.33
1/2"	C _{vs venturi}	3.24
3/4"	C _{vs venturi}	6.16
1"	C _{vs venturi}	11.24
1 1/4"	C _{vs venturi}	23.41
1 1/2"	C _{vs venturi}	34.95
2"	C _{vs venturi}	63.67

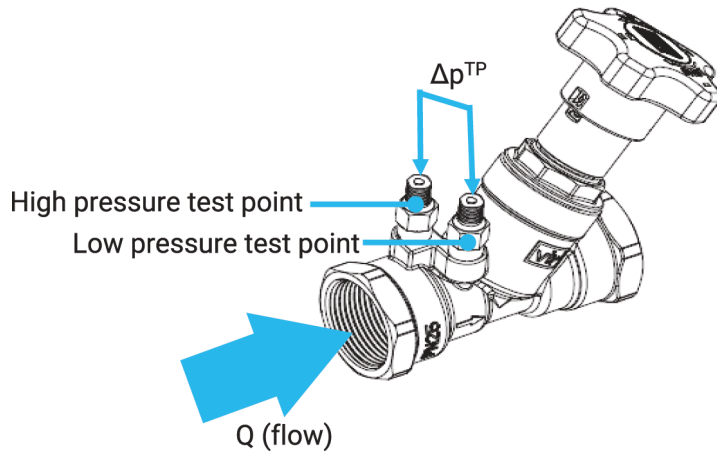

$$Q = C_{vs} \cdot \sqrt{\Delta p^{TP}}$$

Q = flow rate in GPM

Δp = differential pressure signal in psi generated through the pressure test points

C_{vs} = flow coefficient

For additional information on Gruvlok bag and tag coil kit service, contact an ASC Engineered Solutions Representative.

- Introduction
- Couplings
- Outlets
- Fittings
- Valves & Accessories**
- High Pressure
- CTS Copper System
- D-Electric Nipples
- Plan-End Fittings
- HDPE Couplings
- Socket-It® Fittings
- Stainless Steel Method
- Roll Groovers
- Installation & Assembly
- Special Coatings
- Design Services
- Technical Data
- Master Format 3 Part Specs.
- Pictorial Index

Fixed Orifice Double Regulating Valve Fig. Anvil MBV-9510 Series

Headloss

$$\Delta p = \left(\frac{Q}{C_v} \right)^2$$

Formula linking flow Q (in GPM) and theoretical valve headloss (pressure drop) Δp (in psi). C_v depends on handwheel position as indicated in table.

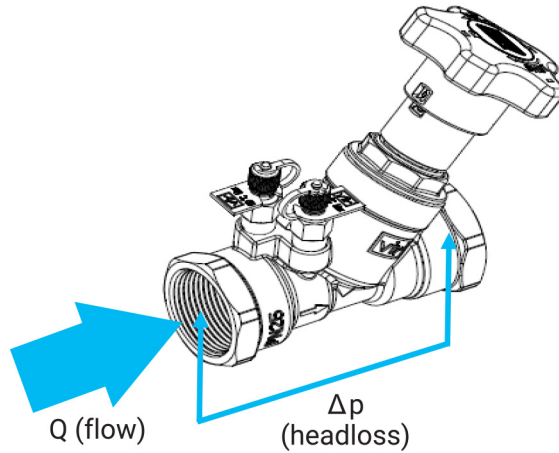

Headloss Calculation

Handwheel Position	C _v (GPM/psi ^{0.5})							
	U-1/2"	L-1/2	1/2	3/4	1"	1 1/4	1 1/2	2"
-	GPM/psi	GPM/psi	GPM/psi	GPM/psi	GPM/psi	GPM/psi	GPM/psi	GPM/psi
0.5	0.177	0.160	0.474	0.474	1.70	2.96	3.14	6.20
0.7	0.206	0.186	0.474	0.543	2.00	3.38	3.61	7.56
1.0	0.283	0.287	0.613	0.671	2.42	3.95	4.27	9.65
1.3	0.331	0.394	0.717	0.809	2.82	4.49	4.96	12.19
1.5	0.355	0.440	0.809	0.902	3.12	4.83	5.57	14.30
1.7	0.387	0.501	0.902	0.994	3.48	5.25	6.60	16.64
2.0	0.445	0.586	0.994	1.12	4.13	6.27	8.99	20.17
2.3	0.511	0.669	1.10	1.25	4.83	7.82	12.08	23.35
2.5	0.517	0.696	1.18	1.39	5.28	9.16	14.21	25.12
2.7	0.527	0.743	1.32	1.62	5.63	10.46	16.34	26.66
3.0	0.563	0.828	1.60	2.24	6.09	12.21	18.89	28.72
3.3	0.578	0.864	1.88	2.94	6.49	13.39	20.67	30.57
3.5	0.594	0.891	2.03	3.39	6.64	13.94	21.54	31.72
3.7	0.595	0.925	2.12	3.75	6.80	14.34	22.16	32.86
4.0	0.603	0.953	2.19	4.06	7.10	14.50	22.65	34.36
4.4	0.605	0.985	2.22	4.24	7.21	-	-	-

For additional information on Gruvlok bag and tag coil kit service, contact an ASC Engineered Solutions Representative.

Fixed Orifice Double Regulating Low Lead Valves Fig. Anvil MBV-9510AB Series

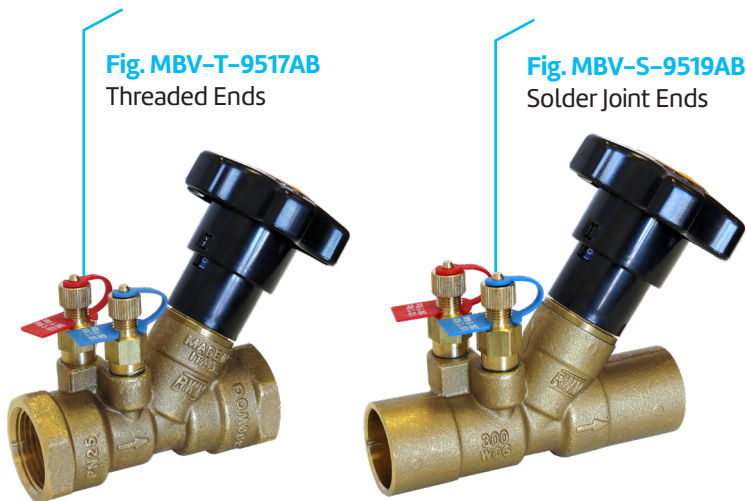

Features

Fixed orifice low lead DZR brass double regulating valve. Intended for HVAC and domestic water use. Threaded F/F (ASME B1.20.1 - NPT) or solder joint ends (ASME B16.22). Design according to BS7350. Tolerance on nominal $C_v \pm 3\%$ (test according to BS7350). 300 WOG (Maximum 300psi up to 160°F. Maximum 150psi at 260°F.)

Available on following versions:

- MBV-T-9517AB, threaded ends, with test points
- MBV-S-9519AB, solder joint ends, with test points

Working Conditions:

- Water (15°F to 260°F)
below 32°F only for water with added anti-freezing fluid
over 212°F only for water with added anti-boiling fluid

For additional information on Gruvlok bag and tag coil kit service, contact an ASC Engineered Solutions Representative.

Material Specifications

- Venturi Insert:** Low Lead DZR Brass ASTM C27453
- Body:** Low Lead DZR Brass ASTM C27453
- Balancing Cone:** Low Lead DZR Brass ASTM C27453
- Gasket Disc:** PTFE
- Disc¹:** Low Lead DZR Brass ASTM C27453
- Disc O-Ring¹:** EPDM Perox
- Disc Stem:** Low Lead DZR Brass ASTM C27453
- Stem O-Ring:** EPDM Perox
- Union¹:** Low Lead DZR Brass ASTM C27453
- Stem:** Brass ASTM B124 C37700
- Bonnet:** Low Lead DZR Brass ASTM C27453
- Stop Spring Ring:** Spring Steel
- Screw:** Steel
- Handwheel:** ABS (Blue)
- Nut:** Zinc Plated Steel
- Test Point:** DZR Brass² ASTM C35330

¹ Only on 1 1/4", 1 1/2" and 2"

² Test points with EPDM gaskets and polypropylene ties

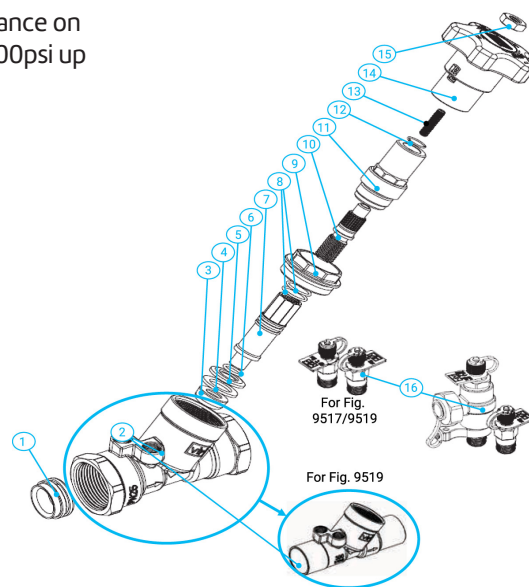

Fixed Orifice Double Regulating Low Lead Valves Fig. Anvil MBV-9510AB Series

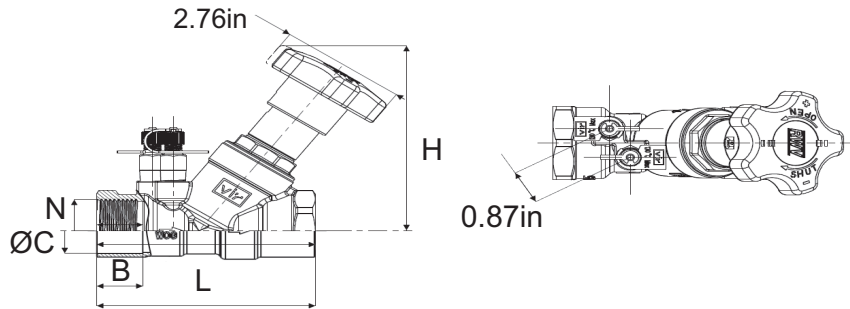

Fixed Orifice Double Regulating Low Lead Valves

Valve Size	N	ØC ¹	H	L ²	B ²	Approx. Wt. ² Each	Flow Range
In./mm	In./mm	In./mm	In./mm	In./mm	In./mm	Lbs./Kg	GPM
U-½ 15	½ - 14 -	0.627-0.631 15.93-16.03	4.06 103.1	3.46/3.74 87.9/95.0	0.71/0.55 18.0/14..0	1.23/1.16 0.56/0.53	0.27-0.71 -
L-½ 15	½ - 14 -	0.627-0.631 15.93-16.03	4.06 103.1	3.46/3.74 87.9/95.0	0.71/0.55 18.0/14..0	1.23/1.16 0.56/0.53	0.49-1.17 -
½ 15	½ - 14 -	0.627-0.631 15.93-16.03	4.06 103.1	3.46/3.74 87.9/95.0	0.71/0.55 18.0/14..0	1.23/1.16 0.56/0.53	0.98-2.35 ³ -
¾ 20	¾ - 14 -	0.877-0.881 22.28-22.38	4.06 103.1	3.78/4.18 96.0/106.2	0.75/0.76 19.1/19.3	1.43/1.34 0.65/0.61	2.19-5.15 ³ -
1 25	1 - 11.5 -	1.128-1.131 28.65-28.73	4.06 103.1	3.94/4.57 100.1/116.1	0.89/0.92 22.6/23.4	1.73/1.55 0.78/0.70	4.09-9.56 ³ -
1¼ 32	1¼ - 11.5 -	1.378-1.381 35.00-35.08	4.06 103.1	4.63/5.28 117.6/134.1	0.98/0.98 24.9/27.9	2.78/2.53 1.26/1.15	8.56-19.81 ³ -
1½ 40	1½ - 11.5 -	1.628-1.632 41.35-41.45	4.06 103.1	5.00/5.90 127.0/149.9	0.98/1.10 24.9/27.9	3.50/3.16 1.59/1.43	12.84-29.80 ³ -
2 50	2 - 11.5 -	2.128-2.132 54.05-54.15	4.06 103.1	5.72/6.73 145.3/170.9	1.15/1.35 29.2/34.3	4.80/4.46 2.18/2.02	24.09-55.63 ³ -

¹ Tolerance field

² Threaded ends/soldering ends

³ Dimension with VIR actuators, for more details please consult specific technical sheet ⁴ Suggested flow range applicability (BS7350)

If used with measuring manometers different from those proposed by Anvil-RWV, please verify that sensibility of the measuring device is compatible with indicated minimum.

For additional information on Gruvlok bag and tag coil kit service, contact an ASC Engineered Solutions Representative.

Fixed Orifice Double Regulating Low Lead Valves

Fig. Anvil MBV-9510AB Series

Flow Diagram

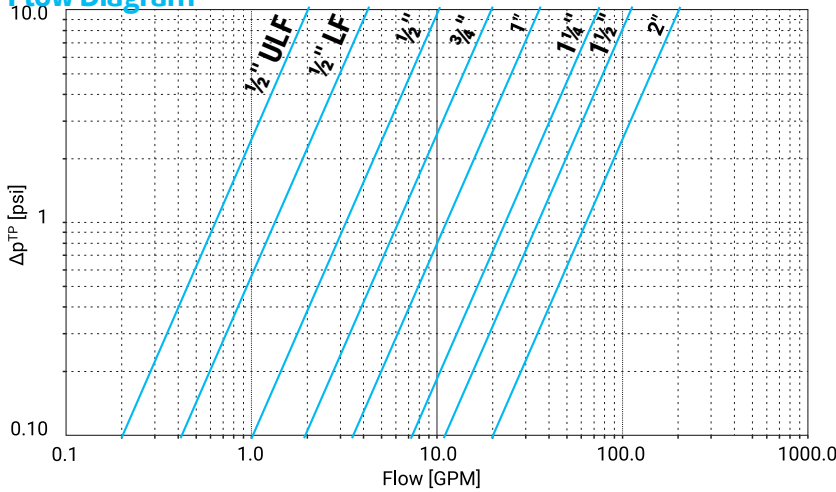

1/2" ULF.....	C _{vs venturi}	0.64
1/2" LF.....	C _{vs venturi}	1.33
1/2"	C _{vs venturi}	3.24
3/4"	C _{vs venturi}	6.16
1"	C _{vs venturi}	11.24
1 1/4"	C _{vs venturi}	23.41
1 1/2"	C _{vs venturi}	34.95
2"	C _{vs venturi}	63.67

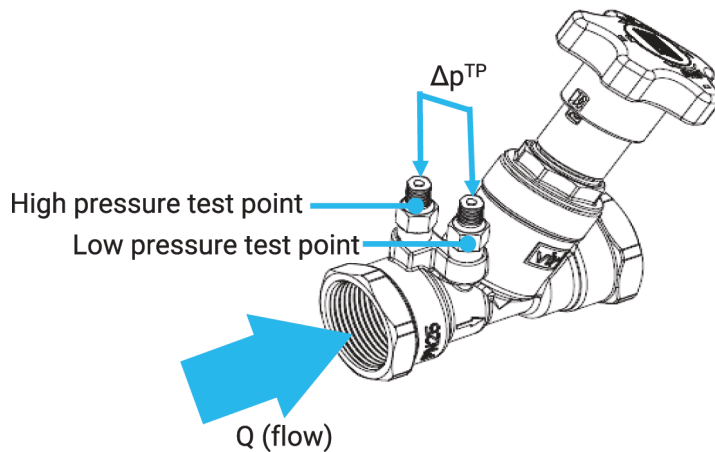

$$Q = C_{vs}^{venturi} \cdot \sqrt{\Delta p^{TP}}$$

Q = flow rate in GPM

Δp = differential pressure signal in psi generated through the pressure test points

C_{vs} = flow coefficient

For additional information on Gruvlok bag and tag coil kit service, contact an ASC Engineered Solutions Representative.

Fixed Orifice Double Regulating Low Lead Valves Fig. Anvil MBV-9510AB Series

Headloss

$$\Delta p = \left(\frac{Q}{C_v} \right)^2$$

Formula linking flow Q (in GPM) and theoretical valve headloss (pressure drop) Δp (in psi). C_v depends on handwheel position as indicated in table.

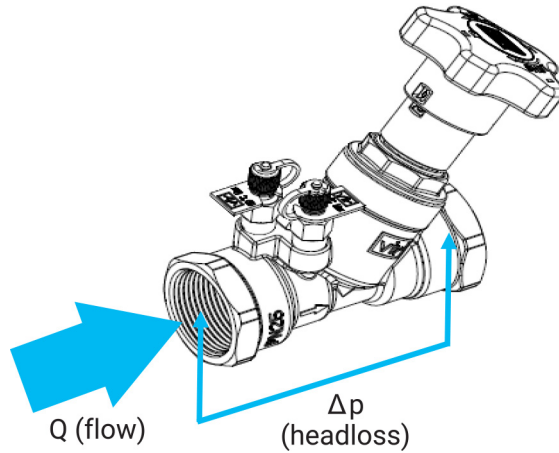

Headloss Calculation

Handwheel Position	C _v (GPM/psi ^{0.5})							
	U-1/2"	L-1/2"	1/2"	3/4"	1"	1 1/4"	1 1/2"	2"
-	GPM/psi	GPM/psi	GPM/psi	GPM/psi	GPM/psi	GPM/psi	GPM/psi	GPM/psi
0.5	0.177	0.160	0.474	0.474	1.70	2.96	3.14	6.20
0.7	0.206	0.186	0.474	0.543	2.00	3.38	3.61	7.56
1.0	0.283	0.287	0.613	0.671	2.42	3.95	4.27	9.65
1.3	0.331	0.394	0.717	0.809	2.82	4.49	4.96	12.19
1.5	0.355	0.440	0.809	0.902	3.12	4.83	5.57	14.30
1.7	0.387	0.501	0.902	0.994	3.48	5.25	6.60	16.64
2.0	0.445	0.586	0.994	1.12	4.13	6.27	8.99	20.17
2.3	0.511	0.669	1.10	1.25	4.83	7.82	12.08	23.35
2.5	0.517	0.696	1.18	1.39	5.28	9.16	14.21	25.12
2.7	0.527	0.743	1.32	1.62	5.63	10.46	16.34	26.66
3.0	0.563	0.828	1.60	2.24	6.09	12.21	18.89	28.72
3.3	0.578	0.864	1.88	2.94	6.49	13.39	20.67	30.57
3.5	0.594	0.891	2.03	3.39	6.64	13.94	21.54	31.72
3.7	0.595	0.925	2.12	3.75	6.80	14.34	22.16	32.86
4.0	0.603	0.953	2.19	4.06	7.10	14.50	22.65	34.36
4.4	0.605	0.985	2.22	4.24	7.21	-	-	-

For additional information on Gruvlok bag and tag coil kit service, contact an ASC Engineered Solutions Representative.

DZR Brass On/Off Terminal Low Lead Balancing Valves Fig. Anvil CSV-9520AB Series



Features

Low lead brass ON/OFF terminal balancing valve for HVAC and domestic water use. Threaded F/F (ASME B1.20.1 – NPT) or solder joint ends (ASME B16.22). Tolerance on nominal C_v for fully open valve + 10% (test according to BS7350). 300 WOG (Maximum 300psi up to 160°F. Maximum 150 psi at 260°F.)

Available on following versions:

CSV-T-9527AB threaded ends

CSV-S-9529AB solder joint ends

Provided with mounted test points. With threaded M30x1.5 connection for linear actuator (Vaurien)

Working Conditions:

- Water (15°F to 260°F) below 32°F only for water with added anti-freezing fluids over 212°F only for water with added anti-boiling fluid

For additional information on Gruvlok bag and tag coil kit service, contact an ASC Engineered Solutions Representative.

Material Specifications

1. **Plug:** CW510L
2. **Body:** CW510L
3. **Disc Gasket:** EPDM Perox
4. **Gasket Washer¹:** CW510L
5. **Balance Disc²:** CW510L
6. **Stem O-Ring:** EPDM Perox
7. **Spring Cartridge:** Brass
8. **Spring:** Stainless Steel
9. **Disc Stem:** Stainless Steel
10. **Stop Ring:** Stainless Steel
11. **Washer:** Brass
12. **Balancing Stem:** CW510L
13. **Balancing Stem O-Ring:** EPDM Perox
14. **Bonnet O-Ring:** EPDM Perox
15. **Bonnet:** CW510L
16. **Graduated Scale:** Blue Polypropylene
17. **Reg. Indicator:** Orange Polyamide
18. **On/Off Cap:** Blue Polyamide
19. **Test Point/Plug:** DZR Brass³

¹ Clamped to stem for 1/2"/3/4", with brass threaded washer for 1".

² In two parts (disc + cone) for 1/2"LF

³ Plug with copper gaskets. Test points with EPDM Perox gaskets and polypropylene ties.

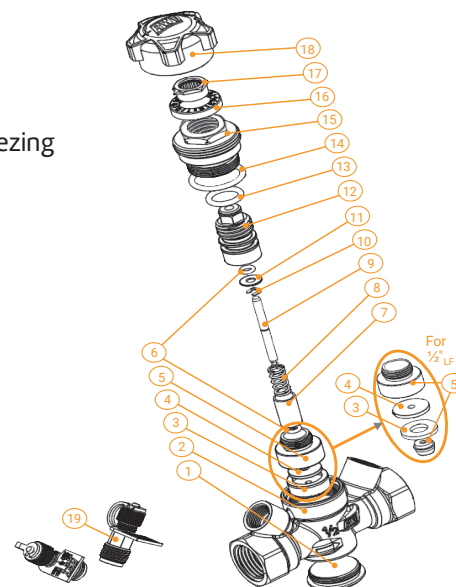

DZR Brass On/Off Terminal Low Lead Balancing Valves Fig. Anvil CSV-9520AB Series

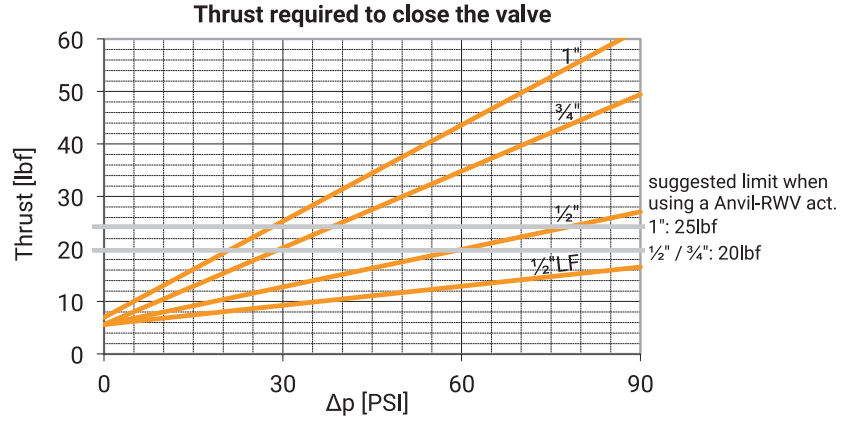
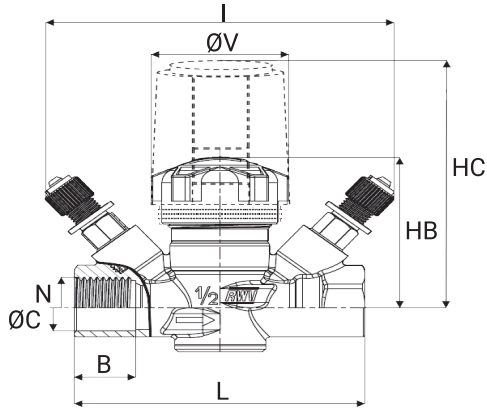

Fig. Anvil CSV-9520AB Series DZR Brass On/Off Terminal Balancing Valve

Valve Size	N	ØC ¹	L ²	B ²	HB	HC ³	ØV	I	Approx. Wt. Each	Flow Range
In./mm	In./mm	In./mm	In./mm	In./mm	In./mm	In./mm	In./mm	In./mm	Lbs./Kg	GPM
1/2 LF	1/2 - 14	0.627-0.631	3.3/3.9	0.65/0.51	2.0	3.3	1.6	3.9	0.77/0.74	0.49/1.17
15	-	15.93-16.03	83.8/99.1	16.5/13.0	50.8	83.8	40.6	99.1	0.35/0.34	-
1/2	1/2 - 14	0.627-0.631	3.3/3.9	0.65/0.51	2.0	3.3	1.6	3.9	0.77/0.74	0.98/2.35 ⁴
15	-	15.93-16.03	83.8/99.1	16.5/13.0	50.8	83.8	40.6	99.1	0.35/0.34	-
3/4	3/4 - 14	0.877-0.881	3.5/4.6	0.76/0.78	2.0	3.3	1.6	4.1	0.99/0.99	2.19/5.15 ⁴
20	-	22.28-22.38	88.9/116.8	19.3/19.8	50.8	83.8	40.6	104.1	0.45/0.45	-
1	1 - 11.5	1.128-1.131	3.9/5.0	0.90/0.92	2.8	4.3	1.6	4.3	1.37/1.27	4.09/9.56 ⁴
25	-	28.65-28.73	99.1/127.0	22.9/23.4	71.1	109.2	40.6	109.2	0.62/0.58	-

¹Tolerance field

²Threaded ends/soldering ends

³Dimension with VIR actuators, for more details please consult specific technical sheet

If using a measuring manometer different from those proposed by Anvil-RWV, please verify that sensibility of the measuring device is compatible with indicated minimum flow (see flow measurement paragraph).

DZR Brass On/Off Terminal Low Lead Balancing Valves Fig. Anvil CSV-9520AB Series

$$Q = C_v \cdot \sqrt{\Delta p^{TP}}$$

Flow Measurement

Formula linking flow Q (in GPM) and Δp measured at test points (in psi).

C_v depends on regulating position as indicated in table.

Minimum flow that can be measured for each diameter may be calculated by using in the formula minimum Δp that can be measured by used manometer.

Valves are anyway designed for best performances when used on range previously suggested.

Flow Measurement

Regulating Position	C _v			
	1/2" LF GPM/psi	1/2" GPM/psi	3/4" GPM/psi	1" GPM/psi
0.5	0.127	0.578	0.798	1.538
1.0	0.173	0.879	1.237	2.405
1.5	0.220	1.098	1.584	3.121
2.0	0.254	1.260	1.896	3.665
2.5	0.289	1.399	2.197	4.162
3.0	0.335	1.514	2.451	4.509
3.5	0.382	1.607	2.671	4.844
4.0	0.428	1.699	2.856	5.226
4.5	0.486	1.769	3.017	5.491
5.0	0.543	1.838	3.179	5.723
5.5	0.601	1.884	3.306	5.942
6.0	0.659	1.931	3.422	6.127
6.5	0.717	1.965	3.526	6.312
7.0	0.775	2.000	3.619	6.555
7.5	0.832	2.035	3.700	6.740
8.0	0.879	2.058	3.792	6.937
8.5	0.925	2.081	3.873	7.087
9.0	0.960	2.104	3.942	7.145
9.5	0.994	2.116	4.012	7.283

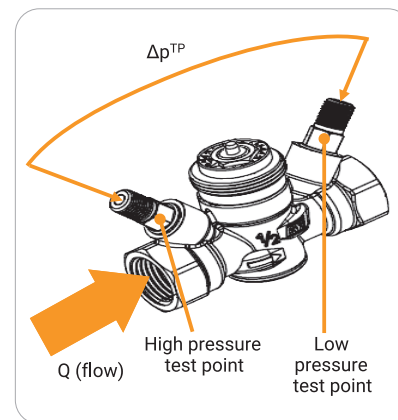

For additional information on Gruvlok bag and tag coil kit service, contact an ASC Engineered Solutions Representative.

DZR Brass On/Off Terminal Low Lead Balancing Valves
Fig. Anvil CSV-9520AB Series

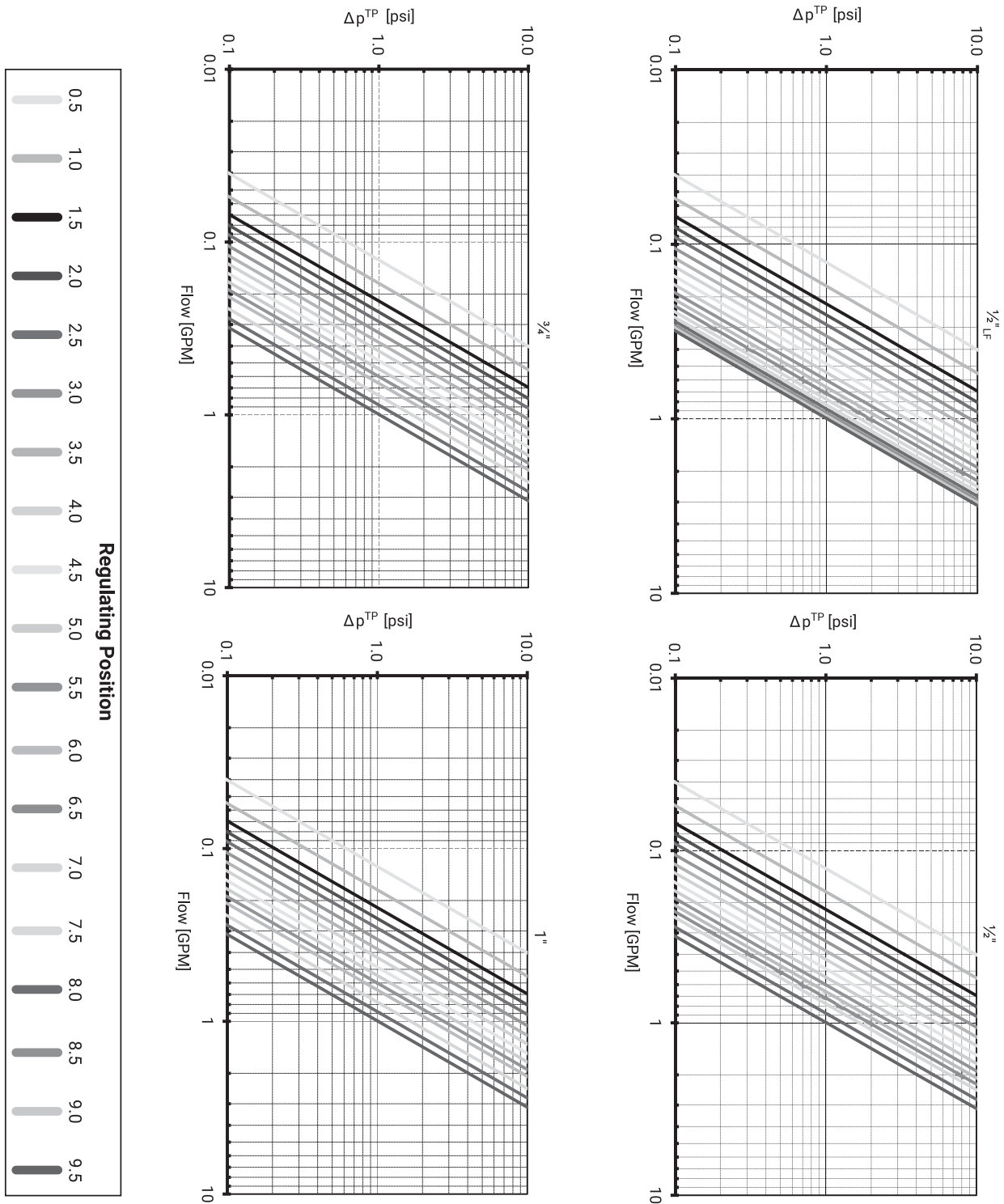

For additional information on Gruvlok bag and tag coil kit service, contact an ASC Engineered Solutions Representative.

DZR Brass On/Off Terminal Low Lead Balancing Valves Fig. Anvil CSV-9520AB Series

$$\Delta p = \left(\frac{Q}{C_v} \right)^2$$

Headloss Calculation

Formula linking flow Q (in GPM) and theoretical valve headloss (pressure drop) Δp (in psi). C_v depends on regulating position as indicated in table.

Headloss Calculation

Regulating Position	C_v (GPM/psi ^{0.5})			
	1/2" LF	1/2"	3/4"	1"
-	GPM/psi	GPM/psi	GPM/psi	GPM/psi
0.5	0.127	0.578	0.798	1.538
1.0	0.173	0.879	1.237	2.405
1.5	0.22	1.098	1.584	3.121
2.0	0.254	1.26	1.896	3.665
2.5	0.289	1.399	2.197	4.162
3.0	0.335	1.514	2.451	4.509
3.5	0.382	1.607	2.671	4.844
4.0	0.428	1.699	2.856	5.226
4.5	0.486	1.769	3.017	5.491
5.0	0.543	1.838	3.179	5.723
5.5	0.601	1.884	3.306	5.942
6.0	0.659	1.931	3.422	6.127
6.5	0.717	1.965	3.526	6.312
7.0	0.775	2.000	3.619	6.555
7.5	0.832	2.035	3.700	6.74
8.0	0.879	2.058	3.792	6.937
8.5	0.925	2.081	3.873	7.087
9.0	0.960	2.104	3.942	7.145
9.5	0.994	2.116	4.012	7.283

For additional information on Gruvlok bag and tag coil kit service, contact an ASC Engineered Solutions Representative.

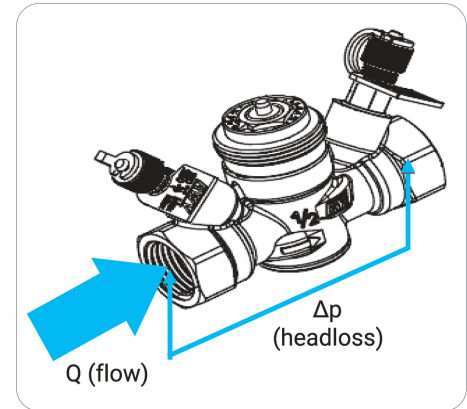

- Introduction
- Couplings
- Outlets
- Fittings
- Valves & Accessories
- High Pressure
- CTS Copper System
- D-I-Electric Nipples
- Plan-End Fittings
- HDPE Couplings
- Socket-It® Fittings
- Stainless Steel Method
- Roll Groovers
- Installation & Assembly
- Special Coatings
- Design Services
- Technical Data
- Master Format 3 Part Specs.
- Pictorial Index

Standard Coil Hook Up Kit Configurations Fig. M2W

Manual 2-Way

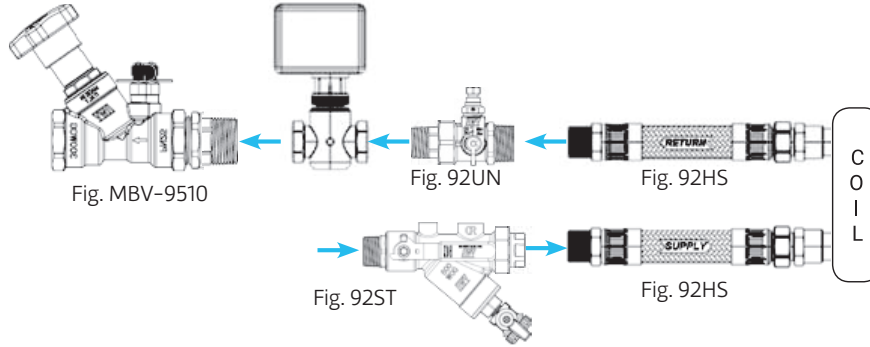

Ordering Options

Supply/Return Line Size

1/2"	3/4"	1"
1 1/4"	1 1/2"	2"



Coil Connection Size

3/8"	1/2"	3/4"	1"
1 1/4"	1 1/2"	2"	



Note: For copper connection
Male / Sweat / "L" type copper

7/8" O.D. = 3/4"
5/8" O.D. = 1/2"
1/2" O.D. = 3/8"

TCV Connection Size

1/2"	3/4"	1"
1 1/4"	1 1/2"	2"



Hoses

No	12"	18"
	24"	36"

Stem Extensions/PT Port Extensions

No	Yes
----	-----

Insulations (for balancing valve only)

No	Yes
----	-----

Supply/Return Connection

FNPT	Sweat
Press	PEX (F-1960)

Coil Connection

FNPT	MNPT
Sweat	

TCV Connection

MNPT
Sweat

Drain Valve

No

5080B

241DV 1/4"
241DV 3/8"
241DV 1/2"

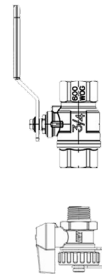

Design Flow

Balancing Valve Size	Recommended (GPM)	
	Min	Max
1/2" X	0.12	0.36
1/2" U	0.27	0.71
1/2" L	0.49	1.17
1/2"	0.98	2.35
3/4"	2.19	5.15
1"	4.09	9.58
1 1/4"	8.56	19.81
1 1/2"	12.84	29.80
2"	24.09	55.63

Automatic Air Vent

No

9390N 1/4"
9390N 3/8"
9390N 1/2"

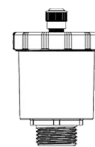

Multiple configurations available.
Product will be seal packed and labeled per the mechanical schedule provided.
For additional information on Gruvlok bag and tag coil kit service, contact an ASC Engineered Solutions Representative.

Standard Coil Hook Up Kit Configurations Fig. M2W

Component Information

- 92ST Combination ball valve / Y-strainer with blow down valve and P/T port, Full Port, DZR brass body, Chrome plated brass ball, 20 mesh SS screen, 400# WOG, 260° F
- 92HS Flexible Hoses, MNPT fixed end x swivel end, EPDM core, SS Braided, EPDM gaskets, 350# WOG (300# WOG for 1 1/2" - 2"), 250° F
- 92UN Union with manual air vent and P/T port, DZR brass body, EPDM o-ring, 400# WOG, 260° F
- MBV-9510 Static Balancing Valve, fixed orifice, with Venturi insert, integral memory stop, FNPT ends, DZR Brass, 300# WOG, 260° F
- 92MU Union, DZR Brass, EPDM O-ring, 400# WOG, 260° F

Flow Range

Balancing Valve Size	Recommended (GPM)	
	Min	Max
1/2" X	0.12	0.36
1/2" U	0.27	0.71
1/2" L	0.49	1.17
1/2"	0.98	2.35
3/4"	2.19	5.15
1"	4.09	9.58
1 1/4"	8.56	19.81
1 1/2"	12.84	29.80
2"	24.09	55.63

- Introduction
- Couplings
- Outlets
- Fittings
- Valves & Accessories**
- High Pressure
- CTS Copper System
- D-I-Electric Nipples
- Plain-End Fittings
- HDPE Couplings
- Sock-It® Fittings
- Stainless Steel Method
- Roll Croovers
- Installation & Assembly
- Special Coatings
- Design Services
- Technical Data
- Master Format 3 Part Specs.
- Pictorial Index

DZR Brass Ball Valve with Strainer Fig. 92ST

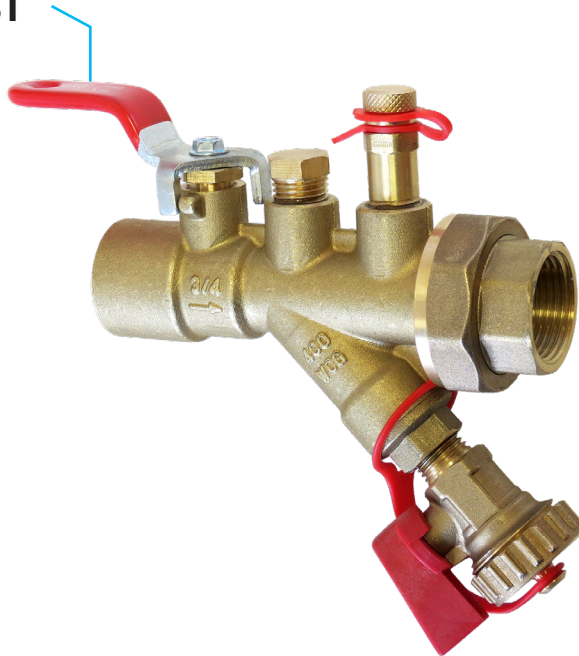

Material Specifications

- 1. Fixed End**
DZR Brass ASTM C35330
- 2. Ball**
Chrome Plated DZR Brass ASTM C35330
- 3. Seat**
PTFE
- 4. Body**
DZR Brass ASTM C35330
- 5. Screw**
Geomet Steel
- 6. Handle**
Geomet Steel¹
- 7. O-Ring**
EPDM Perox
- 8. Stem**
DZR Brass ASTM C35330
- 9. Strainer**
Stainless Steel A304
- 10. Plug Gasket**
EPDM Perox
- 11. Plug**
ZR Brass ASTM C35330
- 12. Plug Gasket**
EPDM Perox
- 13. Test Point/Plug²**
DZR Brass ASTM C35330
- 14. Union End**
DZR Brass ASTM C35330
- 15. Union Nut**
Brass ASTM B283 C37700
- 16. Fitting³**
DZR Brass

Features

- DZR brass ball valve with strainer
- Threaded F/F with union end (ASME B1.20.1 – NPT) (F/M with union end for 3/4", 1" and 2")
- Air testing according EN12266-1
- Blow-out proof stem
- Stainless steel strainer (20 mesh)
- Available with optional test point and/or drain
- 600 WOG (400 WOG for 1 1/2" and 2")

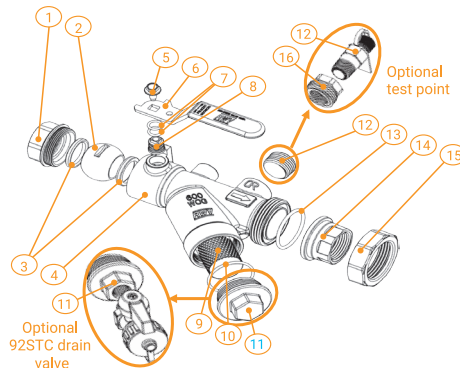

Working Conditions

Water (15°F to 260°F)
below 32°F only for water with added anti-freezing fluid
over 212°F only for water with added anti-boiling fluid

¹ With blue PVC cover

² Test point with EPDM Perox gaskets and polypropylene tie

³ Excluded 1/2" and 3/4"

For additional information on Gruvlok bag and tag coil kit service, contact an ASC Engineered Solutions Representative.

DZR Brass Ball Valve with Strainer Fig. 92ST

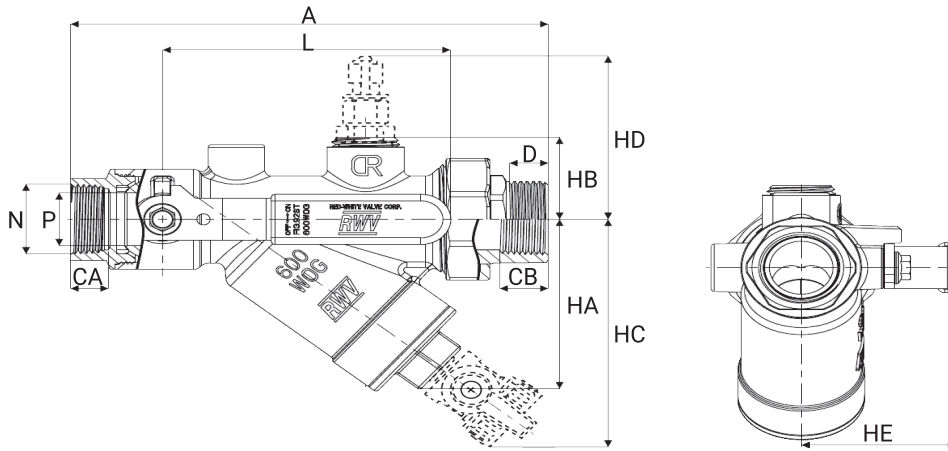

Valve Size	N	A	CA/CB	D	P	HE	L	HA/HC	HB/HD	Approx. Wt. Each ¹
In./mm	In./mm	In./mm	In./mm	In./mm	In./mm	In./mm	In./mm	In./mm	In./mm	Lbs./Kg
1/2 15	1/2 15	4.4 111.8	0.45/0.55 11.4/14.0	- -	0.59 15.0	1.8 45.7	3.6 91.4	1.5/3.1 38.1/78.7	0.8/2.2 20.3/55.9	1.09/1.43 0.49/0.65
3/4 20	3/4 20	5.0 127.0	0.62/- 15.7/-	0.55 14.0	0.59 15.0	1.8 45.7	3.6 91.4	1.5/3.1 38.1/78.7	0.8/2.2 20.3/55.9	1.15/1.49 0.52/0.68
3/4F 20	3/4 20	5.9 149.9	0.47/0.55 11.9/14.0	- -	0.78 19.8	1.9 48.3	3.6 91.4	2.6/3.5 66.0/88.9	1.3/2.6 33.0/66.0	2.45/2.72 1.11/1.23
1 25	1 25	6.7 170.2	0.70/- 17.8/-	0.70 17.8	0.78 19.8	1.9 48.3	3.6 91.4	2.6/3.5 66.0/88.9	1.3/2.6 33.0/66.0	2.55/2.88 1.16/1.31
1 1/4 32	1 1/4 32	8.5 215.9	0.85/0.71 21.6/18.0	- -	1.26 32.0	2.3 58.4	5 127.0	3.7/4.4 94.0/111.8	1.4/2.9 35.6/73.7	5.80/6.16 2.63/2.79
1 1/2 40	1 1/2 40	10.8 274.3	0.85/0.84 21.6/21.3	- -	1.57 39.9	2.9 73.7	5.6 142.2	4.2/4.6 106.7/116.8	1.7/3.2 43.2/81.3	7.59/7.92 3.44/3.59
2 50	2 50	11.2 284.5	0.81/- 20.6/-	1.22 31.0	1.57 39.9	2.9 73.7	5.6 142.2	4.2/4.6 106.7/116.8	1.7/3.2 43.2/81.3	8.09/8.42 3.67/3.82

¹ Weight for standard version/Weight for version with drain ball valve and test points

For additional information on Gruvlok bag and tag coil kit service, contact an ASC Engineered Solutions Representative.

DZR Brass Ball Valve with Bypass
Fig. 92BPC

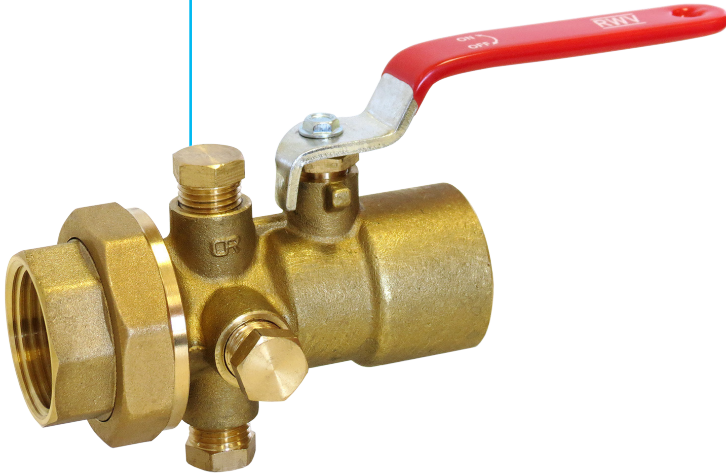

Material Specifications

- 1. Body**
DZR Brass ASTM C35330
- 2. Retainer**
Brass ASTM C37700
- 3. Ball**
Chrome Plated Brass ASTM C37700
- 4. Seat Ring**
PTFE
- 5. Stem**
Brass ASTM C37700
- 6. Stem Seal**
PTFE
- 7. Handle Cover**
PVC
- 8. Screw**
Zinc Plated Steel A304
- 9. Handle**
Zinc Plated Steel A304
- 10. Packing Nut**
Brass ASTM C37700
- 11. O-Ring**
EPDM
- 12. Union Nut**
DZR Brass ASTM C35330
- 13. Seat Ring**
PTFE
- 14. Tail Piece**
DZR Brass ASTM C35330
- 15. Plug**
Brass ASTM C37700
- 16. Stem O-Ring**
EPDM
- 17. Drain Valve**
Brass ASTM C37700

Features

- DZR Brass Ball Valve with Bypass
- Threaded F/F with Union End (ASME B1.20.1 – NPT)
- Blow-out Proof Stem
- Adjustable Packing Nut
- Provided with 1 Test Point and Drain Valve

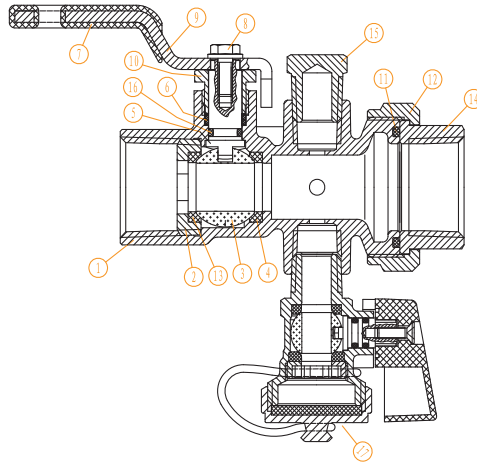

Working Conditions

600WOG @ 160°F
Max. Temperature 260°F
@ 150psi

For additional information on Gruvlok bag and tag coil kit service, contact an ASC Engineered Solutions Representative.

DZR Brass Ball Valve with Bypass Fig. 92BPC

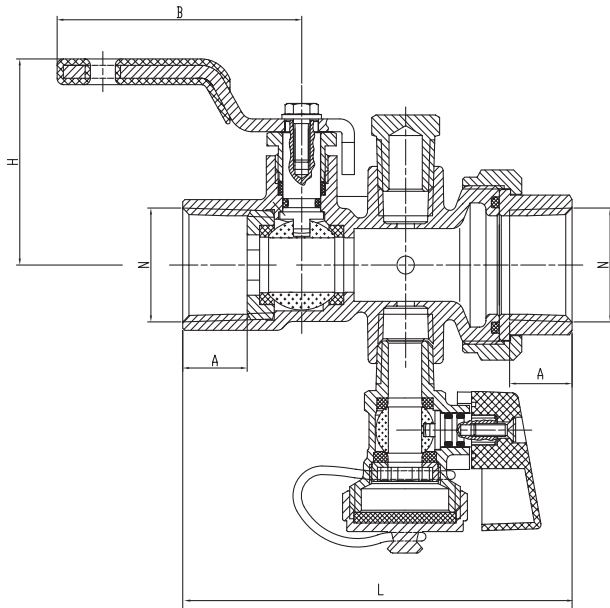

Valve Size	N	A	B	H	L	Approx. Wt. Each
In./mm	In./mm	In./mm	In./mm	In./mm	In./mm	Lbs./Kg
1/2 15	1/2 15	0.6 15.2	2.32 58.9	1.76 44.7	3.73 94.7	0.97 0.44
3/4 20	3/4 20	0.6 15.2	2.32 58.9	1.90 48.3	3.69 93.7	1.13 0.51
1 25	1 25	0.7 17.8	4.05 102.9	2.01 51.1	3.95 100.3	1.48 0.67
1 1/4 32	1 1/4 32	0.7 17.8	4.74 120.4	2.52 64.0	4.39 111.5	2.21 1.00
1 1/2 40	1 1/2 40	0.7 17.8	4.74 120.4	2.61 66.3	4.81 122.2	2.80 1.27
2 50	2 50	0.7 17.8	5.58 141.7	3.46 87.9	5.24 133.1	4.33 1.96

For additional information on Gruvlok bag and tag coil kit service, contact an ASC Engineered Solutions Representative.

Ball Valve with Nut for 9900V Series Valves Fig. 99IBV

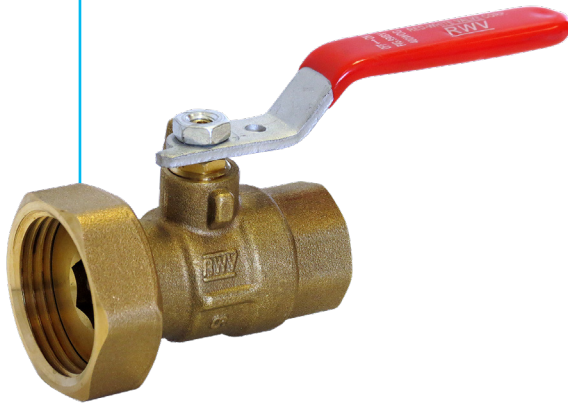

Features

Available on following versions:

- Threaded F inlet (ASME B1.20.1 – NPT)
- Solder joint inlet (ASME B16.22)
- Can be combined with threaded F or solder joint 9900 series valve
- Air testing according to EN12266-1
- Blow-out proof stem, adjustable packing
- 400 WOG

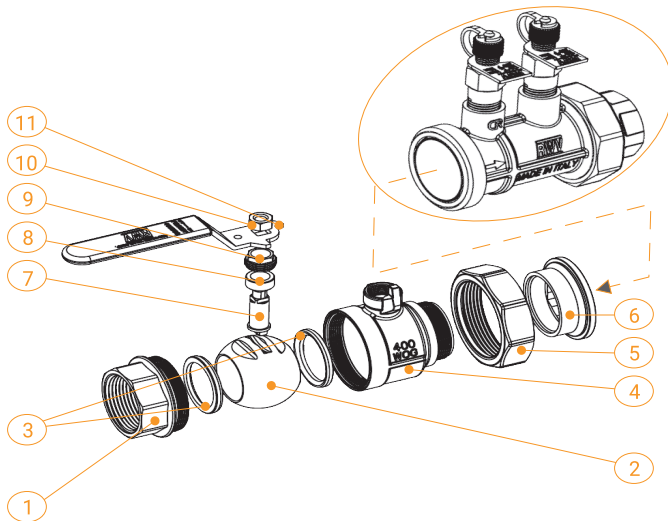

Material Specifications

- 1. Fixed End**
DZR Brass
- 2. Ball**
Chrome Plated DZR Brass
- 3. Seat**
PTFE
- 4. Body**
DZR Brass
- 5. Tail Piece Nut**
Brass
- 6. Tail Piece**
DZR Brass
- 7. Stem**
DZR Brass
- 8. Packing Ring**
PTFE
- 9. Packing Nut**
Brass
- 10. Nut**
Dacromet Steel
- 11. Handle**
Dacromet Steel ¹

¹ With blue PVC COVER

For additional information on Gruvlok bag and tag coil kit service, contact an ASC Engineered Solutions Representative.

Working Conditions

Water (15°F to 260°F)
below 32°F only for water with added anti-freezing fluid
over 212°F only for water with added anti-boiling fluid

Ball Valve with Nut for 9900V Series Valves Fig. 99IBV

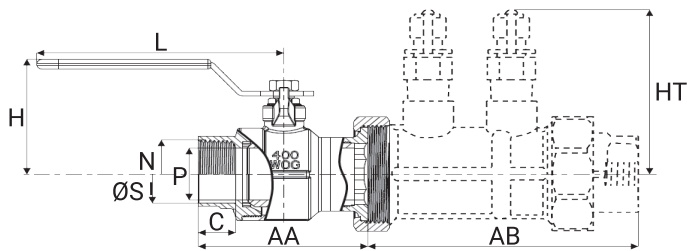

Ball Valve Size ¹	N	ØS ²	B ³	P	AA ³	AB ⁴	HV	HT	L	Approx. Wt. Each ⁵	
										99IBV	9900V
In./mm	In./mm	In./mm	In./mm	In./mm	In./mm	In./mm	In./mm	In./mm	In./mm	Lbs./Kg	Lbs./Kg
½	½	0.627-0.631	0.60/0.51	0.50	2.0/2.0	3.0/3.3/2.8	1.6	2.3	3.2	0.50/0.50	0.73/0.68
15	15	15.93-16.03	15.2/13.0	12.7	50.8/50.8	76.2/83.8/71.1	40.6	58.4	81.3	0.23/0.23	0.33/0.31
¾ LF	¾	0.877-0.881	0.60/0.75	0.50	2.1/2.3	3.4/3.3/3.1	1.6	2.3	3.2	0.53/0.53	0.81/0.70
20	20	22.28-22.38	15.2/19.1	12.7	53.3/58.4	86.4/83.8/78.7	40.6	58.4	81.3	0.24/0.24	0.37/0.32
¾	¾	0.877-0.881	0.60/0.75	0.79	2.4/2.8	3.6/3.9/3.6	2.3	2.6	3.6	0.95/0.97	1.08/1.00
20	20	22.28-22.38	15.2/19.1	20.1	61.0/71.1	91.4/99.1/91.4	58.4	66	91.4	0.43/0.44	0.49/0.45
1	1	1.128-1.131	0.71/0.91	0.79	2.6/2.9	3.7/4.2/3.8	2.3	2.6	3.6	1.04/1.00	1.26/1.09
25	25	28.65-28.73	18.0/23.1	20.1	66.0/73.7	94.0/106.7/96.5	58.4	66	91.4	0.47/0.45	0.57/0.49
1¼	1¼	1.378-1.381	0.73/0.97	1.26	3.3/3.7	5.2/5.5/5.5	2.8	2.9	5.0	2.41/2.20	2.58/2.57
32	32	35.00-35.08	18.5/24.6	32.0	83.8/94.0	132.1/139.7/139.7	71.1	73.7	127.0	1.09/1.00	1.17/1.17
1½	1½	1.628-1.632	0.77/1.09	1.26	3.4/3.9	5.2/5.9/5.6	2.8	2.9	5.0	2.64/2.47	2.78/2.57
40	40	41.35-41.45	19.6/27.7	32.0	86.4/99.1	132.1/149.9/142.2	71.1	73.7	127.0	1.20/1.12	1.26/1.17
2	2	2.128-2.132	0.81/1.34	1.26	3.5/4.4	6.2/6.1/5.9	2.8	2.9	5.0	2.78/2.78	3.36/2.77
50	50	54.05-54.15	20.6/34.0	32.0	88.9/111.8	157.5/154.9/149.9	71.1	73.7	127.0	1.26/1.26	1.52/1.17
2HF	2	2.128-2.132	0.81/1.34	1.97	4.3/5.0	7.8/-/8.2	3.6	3.6	5.6	6.39/6.46	9.06/8.85
50	50	54.05-54.15	20.6/34.0	50.0	109.2/127.0	198.1/-/208.3	91.4	91.4	142.4	2.90/2.93	4.11/4.01
2½	2½	2.628-2.633	1.18/1.49	1.97	4.7/5.2	8.0/-/8.3	3.6	3.6	5.6	7.01/6.68	9.34/8.86
65	65	66.75-68.88	30.0/37.8	50.0	119.4/132.1	203.2/-/210.8	91.4	91.4	142.4	3.18/3.03	4.24/4.02

¹ Also available following 99IBV/9905V combinations: ¾ LF"/1½", 1"/¾", 1½"/1¼", 2"/1½", 2"/2½"

² Tolerance field

³ Threaded ends/soldering ends

⁴ Threaded F ends/threaded M ends/soldering ends

⁵ Threaded ends/soldering ends; weight includes cartridge

For additional information on Gruvlok bag and tag coil kit service, contact an ASC Engineered Solutions Representative.

DZR Brass Union Body with Air Vent and Test Point
Fig. 92UN

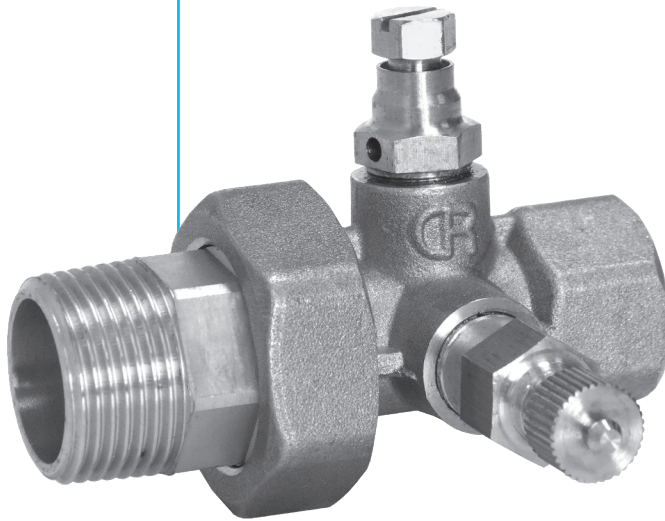

Material Specifications

1. Union Nut
 Brass

2. Union
 DZR Brass

3. Union O-Ring
 EPDM Perox

4. Body
 DZR Brass

5. Vent
 DZR Brass

6. Test Point
 DZR Brass¹

¹ With EPDM Perox gaskets and polypropylene tie

Features

- DZR Brass Union Body with Air Vent and Test Point
- Threaded F or M (ASME B1.20.1 - NPT)
- Solder joint ends (ASME B16.22)
- 400 WOG

Union ends available on following versions

- Threaded M (ASME B1.20.1 - NPT)
- Solder joint ends (ASME B16.22)

Working Conditions

Water (15°F to 260°F)
 below 32°F only for water with added anti-freezing fluid
 over 212°F only for water with added anti-boiling fluid

For additional information on Gruvlok bag and tag coil kit service, contact an ASC Engineered Solutions Representative.

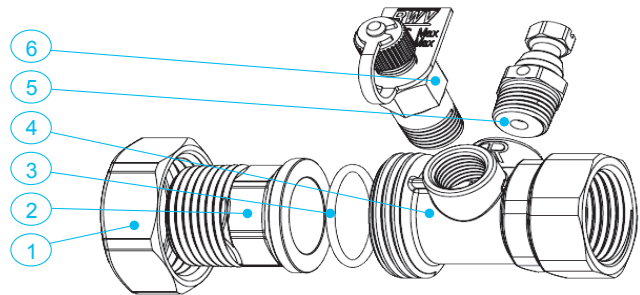

DZR Brass Union Body with Air Vent and Test Point Fig. 92UN

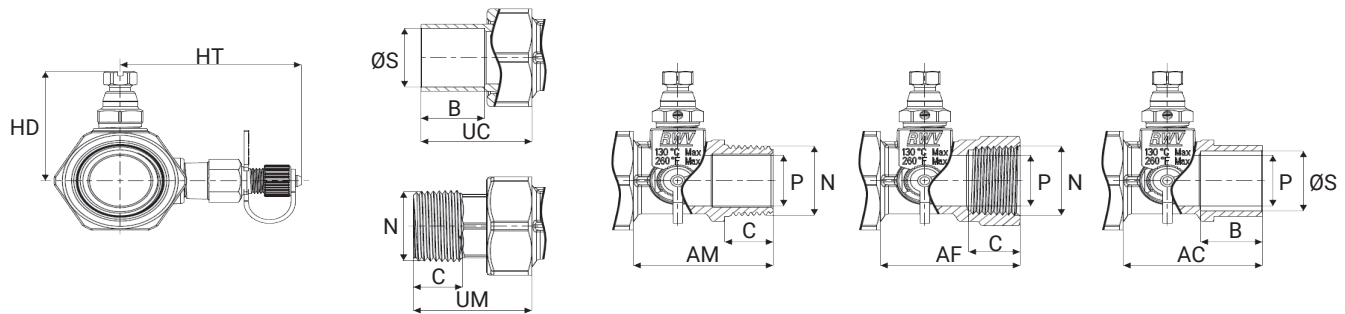

Union Size	N	ØS	C	B	P	AM	AF	AC	UM	UC	HD	HT	Approx. Wt. Each ¹
In./mm	In./mm	In./mm	In./mm	In./mm	In./mm	In./mm	In./mm	In./mm	In./mm	In./mm	In./mm	In./mm	Lbs./Kg
1/2 15	1/2 15	0.627-0.631 15.93-16.03	0.55 14.0	0.51 13.0	0.59 15.0	1.7 43.2	1.6 40.6	1.5 38.1	1.4 35.6	0.9 22.3	1.6 40.6	2.2 55.9	0.50/0.58 0.23/0.26
3/4 20	3/4 20	0.877-0.881 22.28-22.38	0.63 16.0	0.78 19.8	0.74 18.8	1.7 43.2	1.7 43.2	1.7 43.2	1.5 38.1	1.4 35.6	1.6 40.6	2.2 55.9	0.57/0.64 0.26/0.29
1 25	1 25	1.128-1.131 28.65-28.73	0.70 17.8	0.91 23.1	1.00 25.4	1.9 48.3	1.7 43.2	1.9 48.3	1.8 45.7	1.6 40.6	1.9 48.3	2.3 58.4	0.64/0.84 0.29/0.38
1 1/4 32	1 1/4 32	1.378-1.381 35.00-35.08	0.73 18.5	0.98 24.9	1.25 31.8	2.0 50.8	1.8 45.7	2.0 50.8	1.9 48.3	1.7 43.2	2.0 50.8	2.5 63.5	1.01/1.15 0.46/0.53
1 1/2 40	1 1/2 40	1.628-1.632 41.35-41.45	0.77 19.6	1.10 27.9	1.50 38.1	2.1 53.3	1.8 45.7	2.1 53.3	2.2 55.9	1.9 48.3	2.1 53.3	2.5 63.5	1.59/1.90 0.72/0.86
2 50	2 50	2.128-2.132 54.05-54.15	0.80 20.3	1.35 34.3	1.97 50.0	2.1 53.3	1.8 45.7	2.2 55.9	2.3 58.4	2.1 53.3	2.4 61.0	2.8 71.1	1.90/2.26 0.86/1.03

¹ Weight varying in the indicated range depending on the body/union end combination

Stainless Steel Braided Hose – 12", 24" and 36" lengths available Fig. 92HS

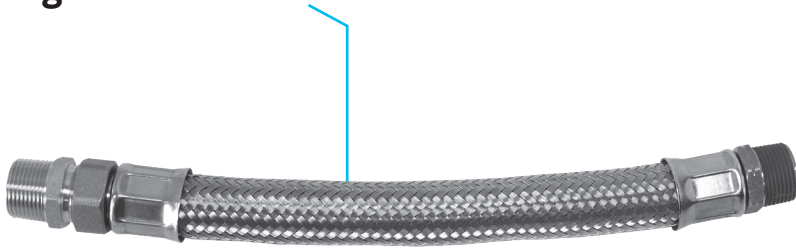

Material Specifications

- 1. Nut**
Brass C36000
- 2. Gasket**
Paper
- 3. Connector**
Stainless Steel AISI304
- 4. Flexible Hose/Inner Pipe**
Stainless Steel/EPDM, AISI304/EPDM
- 5. Screw**
Brass C36000

Features

- Lower risk of leakage
- Fewer field installation joint
- Less installation time and cost
- Fire retardant stainless steel

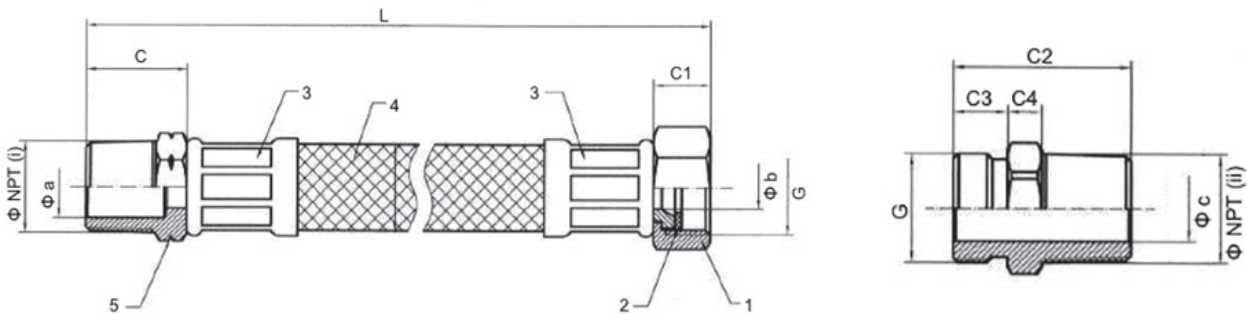

Stainless Steel Braided Hose – 12", 24" and 36" lengths available Fig. 92HS

Hose Size	∅NPT(i)	∅NPT(ii)	∅a	∅b	∅c	C	C1	C2	C3	C4	G	L	Approx. Wt. Each
In./mm	In./mm	In./mm	In./mm	In./mm	In./mm	In./mm	In./mm	In./mm	In./mm	In./mm	In./mm	In./mm	Lbs./Kg
1/2 15	1/2 15	1/2 15	0.55 14.0	0.37 9.4	0.49 12.4	0.91 23.1	0.51 13.0	1.34 34.0	0.41 10.4	0.26 6.6	1/2 15	24/36 610/914	.08/1.1 0.36/0.50
3/4 20	3/4 20	3/4 20	0.79 20.1	0.59 15.0	0.69 17.5	0.93 23.9	0.55 14.0	0.46 11.7	0.47 11.9	0.28 7.1	3/4 20	24/36 610/914	1.2/2.0 0.54/0.91
1 25	1 25	1 25	0.94 23.9	0.75 19.1	0.81 20.6	1.1 28.4	0.61 15.5	0.75 19.1	0.57 14.5	0.31 7.9	1 25	24/36 610/914	1.7/2.8 0.77/1.27
1 1/4 32	1 1/4 32	1 1/4 32	1.17 29.8	0.94 23.8	1.00 25.4	1.12 28.4	0.71 18.5	1.85 47.2	0.58 14.8	0.35 9.0	1 1/4 32	24/36 610/914	3.4/3.7 1.52/1.66
1 1/2 40	1 1/2 40	1 1/2 40	1.41 36.0	1.25 31.8	– –	1.18 30.0	0.75 19.0	– –	– –	– –	1 1/2 40	12 305	2.0 0.89
2 50	2 50	2 50	2.09 53.1	2.09 53.1	– –	2.08 52.8	2.08 52.8	– –	– –	– –	2 50	12 305	2.3 1.02

Note:

1 1/2" and 2" sizes are not available with swivel connection.

For additional information on Gruvlok bag and tag coil kit service, contact an ASC Engineered Solutions Representative.

- Introduction
- Couplings
- Outlets
- Fittings
- Valves & Accessories
- High Pressure
- CTS Copper System
- DI-Electric Nipples
- Plan-End Fittings
- HDPE Couplings
- Socket-Fittings
- Stainless Steel Method
- Roll Groovers
- Installation & Assembly
- Special Coatings
- Design Services
- Technical Data
- Master Format 3 Part Specs.
- Pictorial Index

Balancing Valves GBV-A

**Ductile Iron ASTM A536,
Grade 65-45-12**



Material Specifications

Body, Bonnet

Ductile Iron ASTM A536, Grade 65-45-12

Stem & Disc

Brass Alloy B16

Elastomers

EPDM

Handwheel

Reinforced Nylon; ABS

The Series GBV is a multi-turn, Y-style globe valve designed for accurate determination and control of fluid flow to circuits requiring precise balancing.

Maximum Working Pressure:
300 PSI / 20.7 bar (PN20)

Max. Working Temperature:
230°F (110°C)

Features & Benefit

- Pressure differential ports on both sides of the valve
- Convertible design, straight to 90° angle by removing and replacing four set screws
- Positive shutoff for equipment servicing
- Multi-turn adjustment
- Ergonomically designed handwheel
- Micrometer type adjustment scale
- Tamper-proof hidden memory stop

Balancing Valves GBV-A

2 1/2" to 12" Ductile Iron, Grooved-End or Flanged-End Angle

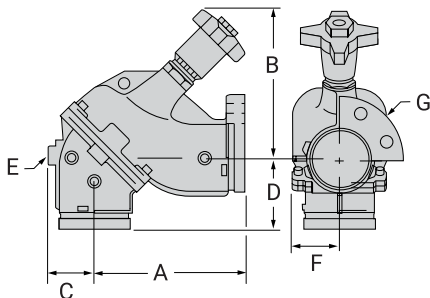

Ductile Iron, Grooved-End or Flanged-End Angle

Nominal Size	O.D.	A	B Open	C	D	E	F	Flange Diameter		Approx. Wt. Each
								G Flange 125#	G Flange 250#	
In./DN(mm)	In./mm	In./mm	In./mm	In./mm	In./mm	In./mm	In./mm	In./mm	In./mm	Lbs./Kg
2 1/2 65	2.875 73.0	7 3/8 187	9 5/8 244	2 3/4 70	4 5/8 117	1 25	2 9/16 65	7 178	7 1/2 191	25 11.3
3 80	3.500 88.9	8 3/16 213	10 1/2 267	2 7/16 61	3 7/8 98	1 25	3 76	7 1/2 191	8 1/4 210	28 12.7
4 100	4.500 114.3	9 5/8 244	10 9/16 268	3 76	4 3/8 111	1 1/4 32	3 7/16 87	9 1/4 235	10 254	41 18.6
5 125	5.563 141.3	12 305	13 1/16 331	3 5/8 92	5 1/2 140	1 1/4 32	4 15/16 125	10 254	11 279	90 40.8
6 150	6.625 168.3	14 1/8 359	13 3/4 349	4 7/16 112	6 5/8 168	2 51	5 7/8 149	11 279	12 1/2 318	130 59.0
8 200	8.625 219.1	18 9/16 481	24 5/8 625	5 11/16 144	9 3/16 233	2 1/4 57	7 7/8 200	13 1/2 343	15 381	310 140.6
10 250	10.750 273.1	20 9/16 515	26 1/2 673	6 9/16 166	9 3/4 248	2 1/4 57	9 15/32 240	16 406	17 1/2 445	460 208.7
12 300	12.750 323.9	24 1/16 611	28 7/16 722	7 5/8 194	14 356	2 1/4 57	12 5/8 321	19 483	20 1/2 521	870 394.6

Note: Grooved-Ends are for connection of components with dimensions conforming to Gruvlok® standard grooved Specifications for IPS pipe. See www.asc-es.com for installation instructions and flow data.

Balancing Valves GBV-G

**Ductile Iron ASTM A536,
Grade 65-45-12**



Material Specifications

Body, Bonnet

Ductile Iron ASTM A536, Grade 65-45-12

Stem & Disc

Brass Alloy B16

Elastomers

EPDM

Handwheel

Reinforced Nylon; ABS

The Series GBV is a multi-turn, Y-style globe valve designed for accurate determination and control of fluid flow to circuits requiring precise balancing.

Maximum Working Pressure:
300 PSI / 20.7 bar (PN20)

Max. Working Temperature:
230°F (110°C)

Features & Benefit

- Pressure differential ports on both sides of the valve
- Convertible design, straight to 90° angle by removing and replacing four set screws
- Positive shutoff for equipment servicing
- Multi-turn adjustment
- Ergonomically designed handwheel
- Micrometer type adjustment scale
- Tamper-proof hidden memory stop

Balancing Valves GBV-G

2 1/2" to 12" Ductile Iron, Grooved-End or Flanged-End Straight

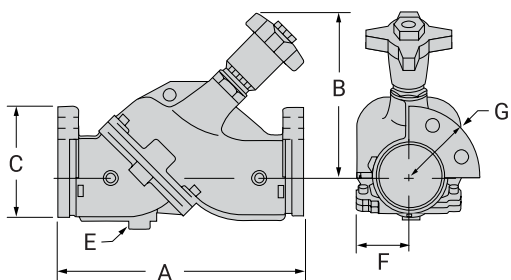

Ductile Iron, Grooved-End or Flanged-End Straight

Nominal Size	O.D.	A	B Open	C	E	F	Flange Diameter		Approx. Wt. Each
							G Flange 125#	G Flange 250#	
In./DN(mm)	In./mm	In./mm	In./mm	In./mm	In./mm	In./mm	In./mm	In./mm	Lbs./Kg
2 1/2 65	2.875 73.0	12 305	9 5/8 244	2 3/4 70	1 25	2 9/16 65	7 178	7 1/2 191	25 11.3
3 80	3.500 88.9	12 305	10 1/2 267	2 7/16 61	1 25	3 76	7 1/2 191	8 1/4 210	28 12.7
4 100	4.500 114.3	14 356	10 9/16 268	3 76	1 1/4 32	3 7/16 87	9 1/4 235	10 254	41 18.6
5 125	5.563 141.3	17 1/2 445	13 1/16 331	3 5/8 92	1 1/4 32	4 15/16 125	10 254	11 279	90 40.8
6 150	6.625 168.3	20 11/16 525	13 3/4 349	4 7/16 112	2 51	5 7/8 149	11 279	12 1/2 318	130 59.0
8 200	8.625 219.1	28 3/16 716	24 5/8 625	5 11/16 144	2 1/4 57	7 7/8 200	13 1/2 343	15 381	310 140.6
10 250	10.750 273.1	30 762	26 1/2 673	6 9/16 166	2 1/4 57	9 15/32 240	16 406	17 1/2 445	460 208.7
12 300	12.750 323.9	38 1/16 966	28 7/16 722	7 5/8 194	2 1/4 57	12 5/8 321	19 483	20 1/2 521	870 394.6

Note: Grooved-Ends are for connection of components with dimensions conforming to Gruvlok® standard grooved Specifications for IPS pipe.

Circuit Balancing Valves Model CB800



Material Specifications

Body

Grooved or Flanged Connection: Cast Iron

Stem

Dezincification resistant brass

Valve Disc

Bronze

O-Ring

EPDM

Handwheel

Thermoplastic

For accessories and replacement parts contact an ASC Engineered Solutions Sales Representative for details.

Model CB800 Circuit Balancing Valves are designed to achieve accurate and efficient balancing of hydronic heating or cooling systems. Circuit Balancing Valves provide superior accuracy in measuring flows rather than ball type circuit setters.

The CB800 valve serves 5 functions:

- Throttling
- Measuring differential pressure
- Draining
- Filling
- Positive shutoff

These valves are rated at 300 psi (20.7 bar) at 300 F (150°C). Flanged (125#) and grooved connections are available for sizes 2½" – 12" (65mm – 300mm) with cast iron bodies.

The Y-Pattern style provides low pressure drop. The globe style valve allows for precise throttling. The easy-to-adjust digital/vernier handwheel provides a minimum of 70 unique handwheel positions. The handwheel and test ports are located on one side for easy access. A built-in memory stop ensures the setting can be returned to a balanced position after shutoff. The self-sealing pressure/temperature test ports use standard insertion probes to eliminate additional components.

The Gruvlok® Circuit Balancing Valve is installed with flow in the direction of the arrow, and may be in the horizontal or vertical position. The handwheel can be positioned up or down, or on either side.

Maximum Working Pressure: 300 psi (20.7 bar) Grooved Connection
235 psi (16.0 bar) Flanged Connection

Circuit Balancing Valves Model CB800

Valve Sizing

All balancing valves are sized to perform in a normal operation range between 25% and 100% of the full open position, at a minimum differential pressure between 1 – 3 ft. (0.3m – 0.9m) of water. It is recommended that for improved accuracy, the valve is set to open 70%+.

When maximum flow is known but a pressure drop through the balancing valve is unknown, select a balancing valve for a maximum pressure drop of 2 ft. (0.6m) water 0.8 psi (0.06 bar) in the full open position as shown in the table to the right.

Accurate flow measurement requires that the velocity distribution near the balancing valve remains constant, regardless of the total flow through the pipe. Fittings, such as elbows and tees, disturb the normal flow profile which

is established through straight pipe. Pumps create even greater disturbances. Failure to allow water flows around fittings and pumps to normalize can affect measuring accuracy by as much as 20% when the valve is in the fully open position. Minimum lengths (diameters, D) of straight pipe before and after the balancing valve prevent these errors.

Valves are designed for vertical, horizontal, or inclined installation.

CB800 Circuit Balancing Valves

Valve Size	Flow Rate	Connection Type
In./mm	GPM/LPM	-
2½ 65	39 - 106 10.30 - 28.01	Flanged or Grooved
76.1mm 65	39 - 106 10.30 - 28.01	
3 80	60 - 132 15.85 - 34.87	
4 100	100 - 217 26.42 - 57.33	
139.7mm 125	112 - 317 29.59 - 83.75	
5 125	112 - 317 29.59 - 83.75	
165.1mm 150	220 - 437 58.12 - 115.46	
6 150	220 - 437 58.12 - 115.46	
8 200	223 - 881 58.92 - 232.76	
10 250	292 - 1298 77.15 - 342.93	
12 300	616 - 1731 162.75 - 457.33	

- Introduction
- Couplings
- Outlets
- Fittings
- Valves & Accessories
- High Pressure
- CTS Copper System
- D-I-Electric Nipples
- Plan-End Fittings
- HDPE Couplings
- Socket-It® Fittings
- Stainless Steel Method
- Roll Groovers
- Installation & Assembly
- Special Coatings
- Design Services
- Technical Data
- Master Format 3 Part Specs.
- Pictorial Index

Circuit Balancing Valves – Grooved Ends Model CB800

The Model CB800 Balancing Valve provides features for achieving accurate and efficient balancing of hydronic heating or cooling systems.

The Gruvlok Groove-by-Groove Model CB800 Valve, available sizes 2½" to 12" (65 to 300mm), is composed of cast iron.

The CB800 valve serves 5 functions:

- Throttling
- Measuring differential pressure
- Draining
- Filling
- Positive shutoff



CB800 Circuit Balancing Valves – Grooved Ends

Valve Size	O.D.	Dimensions			Approx. Wt. Ea.	Limits	Handwheel Turns
		A	B	C			
In./mm	In./mm	In./mm	In./mm	In./mm	Lbs./Kg	PSI/°F • PN/°C	-
2½	2.875	11.44	7.38	4.33	19.7	300/300	8
65	73.0	290.6	187.5	110.0	8.9	20.7/150	
76.1mm	3.000	11.44	7.38	4.33	19.7	300/300	8
65	76.1	290.6	187.5	110.0	8.9	20.7/150	
3	3.500	12.25	8.00	4.33	27.8	300/300	8
80	88.9	311.2	203.2	110.0	12.6	20.7/150	
4	4.500	13.75	9.44	6.30	45.3	300/300	8
100	114.3	349.3	239.8	160.0	20.6	20.7/150	
139.7mm	5.500	15.75	11.13	6.30	70.0	300/300	8
125	139.7	400.0	282.7	160.0	31.8	20.7/150	
5	5.563	15.75	11.13	6.30	70.0	300/300	8
125	141.3	400.0	282.7	160.0	31.8	20.7/150	
165.1mm	6.500	18.88	11.25	6.30	95.7	300/300	8
150	165.1	479.6	285.8	160.0	43.5	20.7/150	
6	6.625	18.88	11.25	6.30	95.7	300/300	8
150	168.3	479.6	285.8	160.0	43.5	20.7/150	
8	8.625	23.63	18.44	11.8	255.2	300/300	12
200	219.1	600.2	468.4	300.0	116	20.7/150	
10	10.750	28.75	18.88	11.80	377.3	300/300	12
250	273.1	730.3	479.6	300	171.5	20.7/150	
12	12.750	33.44	20.25	11.80	520.3	300/300	12
300	323.9	849.4	514.4	300.0	236.5	20.7/150	

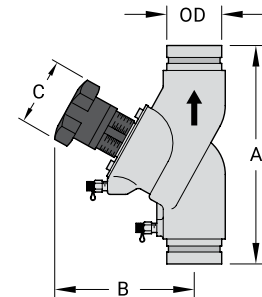

2½" to 6" (65 to 150mm)

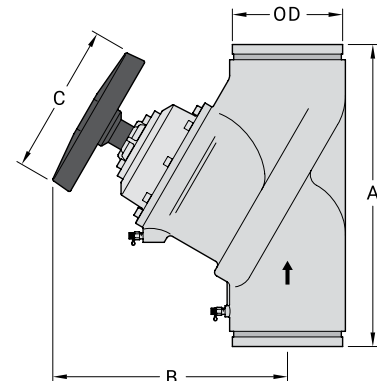

8" to 12" (200 to 300mm)

For information on larger sizes, contact an ASC Engineered Solutions Sales Representative.
See circuit balancing valve Specifications on pages 1-2.

Circuit Balancing Valves – Flanged Ends, ANSI Class 125# Model CB800

The Model CB800 Balancing Valve provides features for achieving accurate and efficient balancing of hydronic heating or cooling systems. One valve serves five functions: throttling, measuring (pressure and temperature), positive shutoff, draining, and filling. The Gruvlok Flange-by-Flange Model CB800 Valve, available in sizes 2½" to 12" (65mm to 300mm), is composed of cast iron.

The CB800 valve serves 5 functions:

- Throttling
- Measuring differential pressure
- Draining
- Filling
- Positive shutoff

CB800 Circuit Balancing Valves – Flanged Ends, ANSI Class 125#

Valve Size	O.D.		Dimensions				Approx. Wt. Ea.	Limits	Handwheel Turns
	In./mm	In./mm	A	B	C	D			
2½"	2.875	11.44	7.38	4.33	7.25	31.7	235/300	8	
65	73.0	290.6	187.5	110.0	184.2	14.4	16/150		
76.1mm	3.000	11.44	7.38	4.33	7.25	31.7	235/300	8	
65	76.1	290.6	187.5	110.0	184.2	14.4	16/150		
3	3.500	12.25	8.00	4.33	7.88	39.8	235/300	8	
80	88.9	311.2	203.2	110.0	200.2	18.0	16/150		
4	4.500	13.75	9.50	6.30	8.69	61.3	235/300	8	
100	114.3	349.3	241.3	160.0	220.7	27.8	16/150		
139.7mm	5.500	15.75	11.13	6.30	9.88	89.9	235/300	8	
125	139.7	400.1	282.7	160.0	250.9	40.9	16/150		
5	5.563	15.75	11.13	6.30	9.88	89.9	235/300	8	
125	141.3	400.1	282.7	160.0	250.9	40.9	16/150		
165.1mm	6.500	18.88	11.25	6.30	11.25	113.9	235/300	8	
150	165.1	479.6	285.8	160.0	285.8	51.8	16/150		
6	6.62500	18.88	11.25	6.30	11.25	113.9	235/300	8	
150	168.3	479.6	285.8	160.0	285.8	51.8	16/150		
8	8.625	23.63	18.38	11.80	13.38	361.9	235/300	12	
200	219.1	600.2	466.9	300.0	339.9	164.5	16/150		
10	10.750	28.75	18.94	11.80	15.94	431.2	235/300	12	
250	273.1	730.3	481.1	300.0	404.9	196.0	16/150		
12	12.750	33.50	20.25	11.80	18.13	581.9	235/300	12	
300	323.9	850.9	514.4	300.0	460.5	264.5	16/150		

For information on larger sizes, contact an ASC Engineered Solutions Sales Representative. See circuit balancing valve Specifications on pages 1-2.

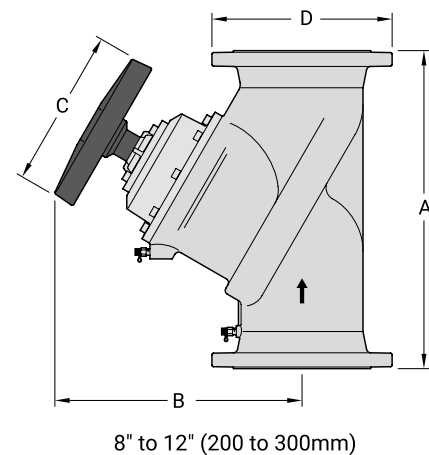
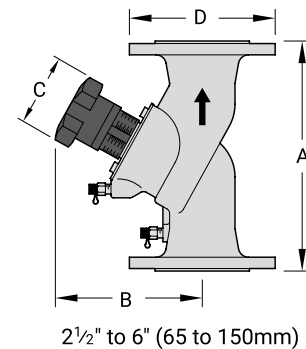
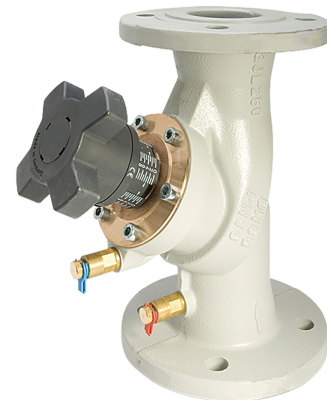

Circuit Balancing Valves – Flanged Ends, PN16/PN10 Model CB800

The Model CB800 Balancing Valve provides features for achieving accurate and efficient balancing of hydronic heating or cooling systems. One valve serves five functions: throttling, measuring (pressure and temperature), positive shutoff, draining, and filling. The Gruvlok Flange-by-Flange Model CB800 Valve, available in sizes 2½" to 12" (65mm to 300mm), is composed of cast iron.

The CB800 valve serves 5 functions:

- Throttling
- Measuring differential pressure
- Draining
- Filling
- Positive shutoff

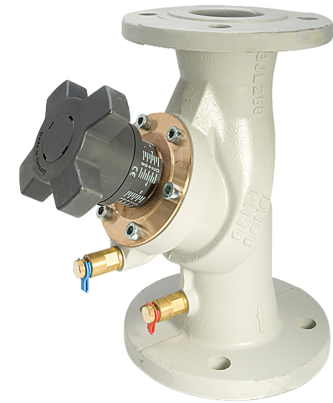

CB800 Circuit Balancing Valves – Flanged Ends, PN16/PN10

Valve Size	O.D.	Dimensions				Approx. Wt. Ea.	Limits	Handwheel Turns
		A	B	C	D			
In./mm	In./mm	In./mm	In./mm	In./mm	In./mm	Lbs./Kg	PSI/°F • PN/°C	-
2½"	2.875	11.44	7.38	4.33	7.25	31.7	235/300	8
65	73.0	290.6	187.5	110.0	184.2	14.4	16/150	
76.1mm	3.000	11.44	7.38	4.33	7.25	31.7	235/300	8
65	76.1	290.6	187.5	110.0	184.2	14.4	16/150	
3"	3.500	12.25	8.00	4.33	7.88	39.8	235/300	8
80	88.9	311.2	203.2	110.0	200.2	18.0	16/150	
4"	4.500	13.75	9.50	6.30	8.69	61.3	235/300	8
100	114.3	349.3	241.3	160.0	220.7	27.8	16/150	
139.7mm	5.500	15.75	11.13	6.30	9.88	89.9	235/300	8
125	139.7	400.1	282.7	160.0	250.9	40.9	16/150	
5"	5.563	15.75	11.13	6.30	9.88	89.9	235/300	8
125	141.3	400.1	282.7	160.0	250.9	40.9	16/150	
165.1mm	6.500	18.88	11.25	6.30	11.25	113.9	235/300	8
150	165.1	479.6	285.8	160.0	285.8	51.8	16/150	
6"	6.625	18.88	11.25	6.30	11.25	113.9	235/300	8
150	168.3	479.6	285.8	160.0	285.8	51.8	16/150	
8"	8.625	23.63	18.38	11.80	13.38	361.9	235/300	12
200	219.1	600.2	466.9	300.0	339.9	164.5	16/150	
10"	10.750	28.75	18.94	11.80	15.94	431.2	235/300	12
250	273.1	730.3	481.1	300.0	404.9	196.0	16/150	
12"	12.750	33.50	20.25	11.80	18.13	581.9	235/300	12
300	323.9	850.9	514.4	300.0	460.5	264.5	16/150	

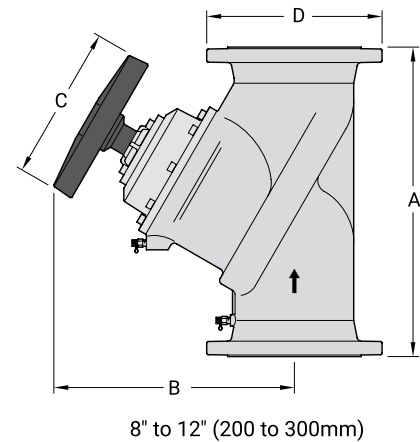
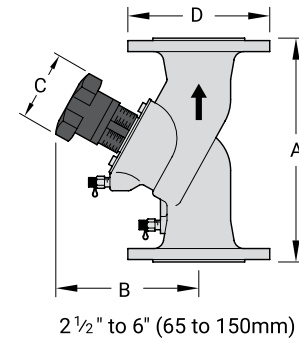

For information on larger sizes, contact an ASC Engineered Solutions Sales Representative. See circuit balancing valve Specifications on pages 1-2.

Circuit Balancing Valves Model CB800



CB800
Flanged Ends

CB800
Grooved Ends



Calibrated Balancing Valve Flow Specifications Grooved and Flanged Ends

Valve Size	Absolute Minimum Flow	Recommended Minimum Flow	Recommended Maximum Flow	Absolute Maximum Flow
In./mm	GPM(L/s)			
2½ 65	1.4 0.088	47 2.97	106.0 6.69	335.3 21.15
3 80	1.5 0.095	48 3.03	132.2 8.34	418.1 26.38
4 100	1.9 0.120	78 4.92	217.5 13.72	687.7 43.39
5 125	4.2 0.265	87 5.49	317.0 20.00	1,002 63.2
6 150	5 0.315	180 11.36	437.4 27.60	1,383 87.3
8 200	30 1.89	163 10.28	881.3 55.60	2,787 175.8
10 250	70 4.42	210 13.25	1,298 81.9	4,106 259.1
12 300	115 7.26	518 32.68	1,731 109.2	5,474 345.4

- Introduction
- Couplings
- Outlets
- Fittings
- Valves & Accessories
- High Pressure
- CTS Copper System
- DI-Electric Nipples
- Plan-End Fittings
- HDPE Couplings
- Sock-It® Fittings
- Stainless Steel Method
- Roll Groovers
- Installation & Assembly
- Special Coatings
- Design Services
- Technical Data
- Master Format 3 Part Specs.
- Pictorial Index

Circuit Balancing Valves Model CB800

Flow Measurement Accuracy

2½" - 6" Valves Flow Measuring Tolerance

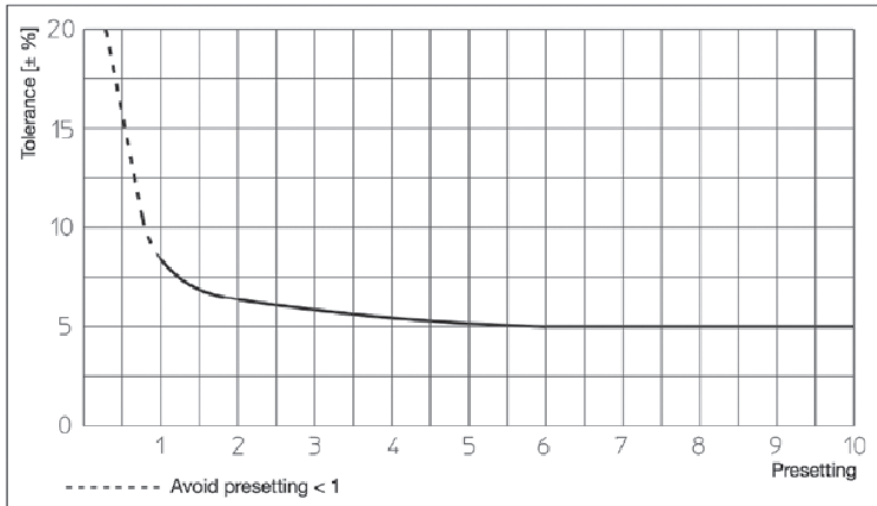

8" - 12" Valves Flow Measuring Tolerance

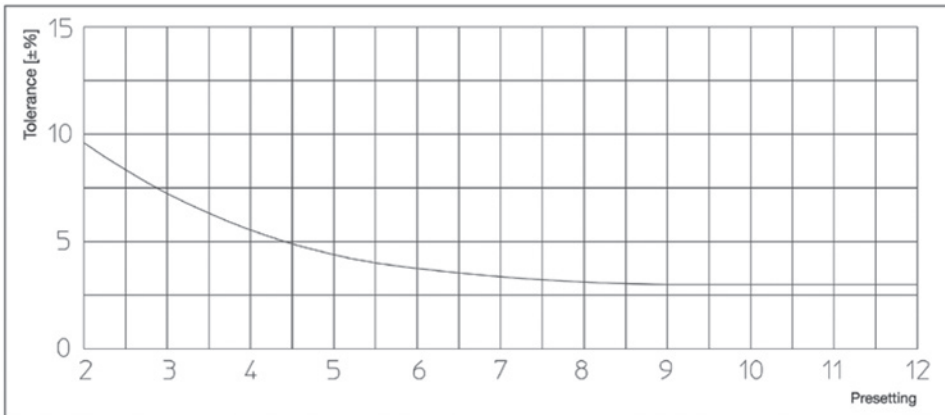

Circuit Balancing Valves Model CB800

Size: 2 1/2"

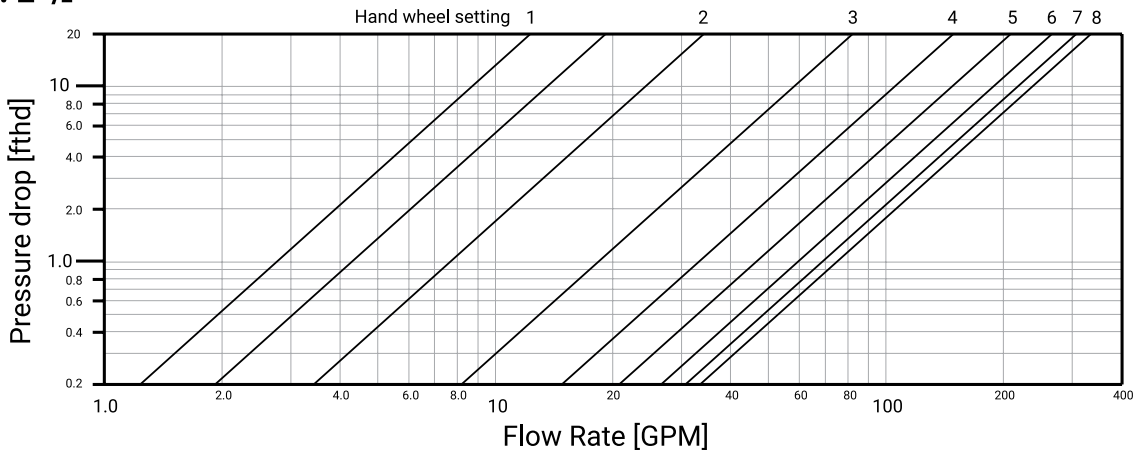

Size: 3"

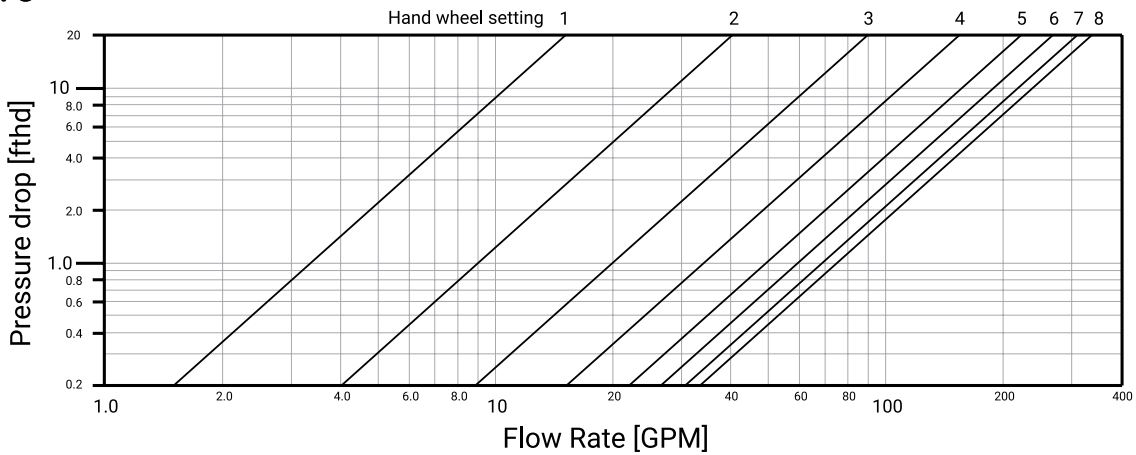

Size: 4"

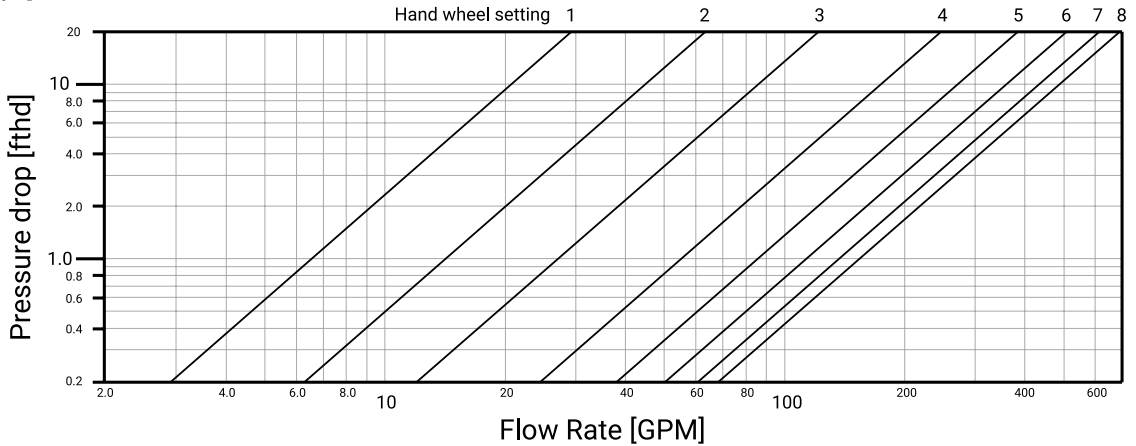

**Circuit Balancing Valves
Model CB800**

Size: 5"

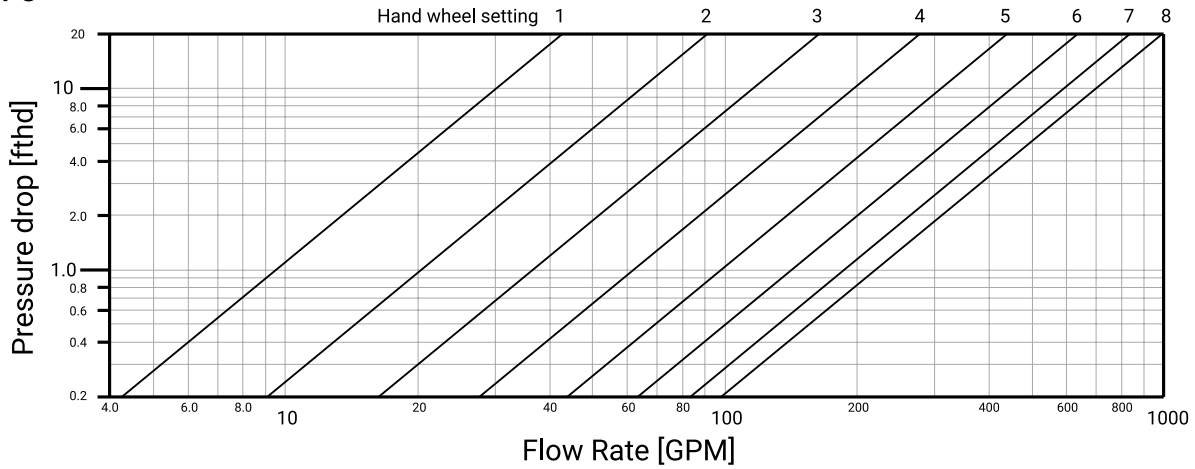

Size: 6"

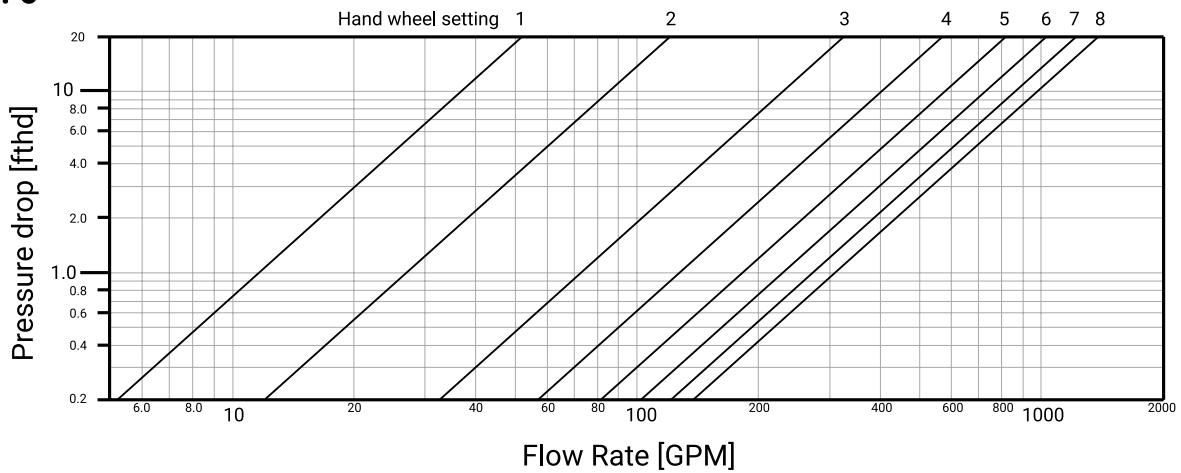

Size: 8"

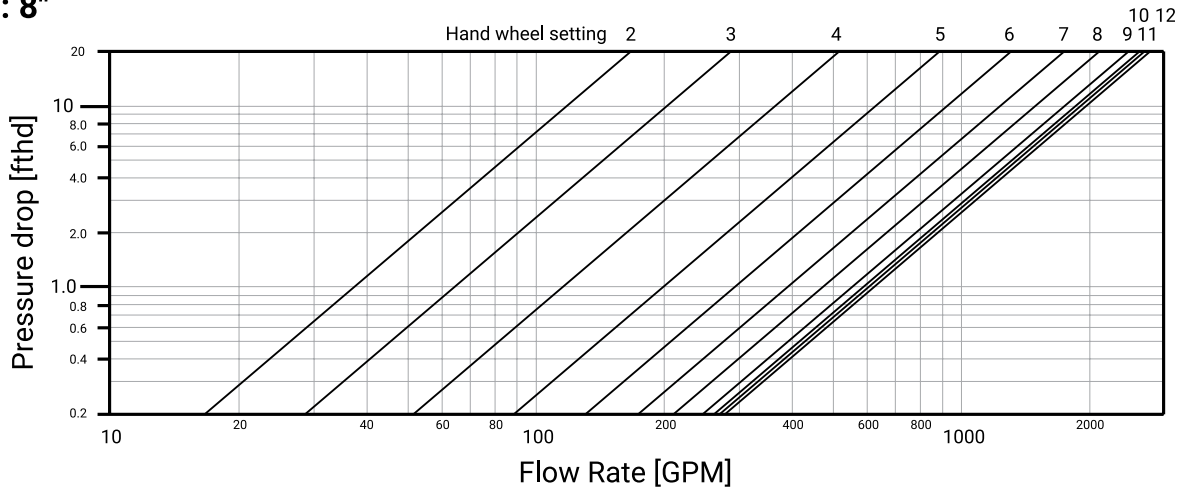

Circuit Balancing Valves Model CB800

Size: 10"

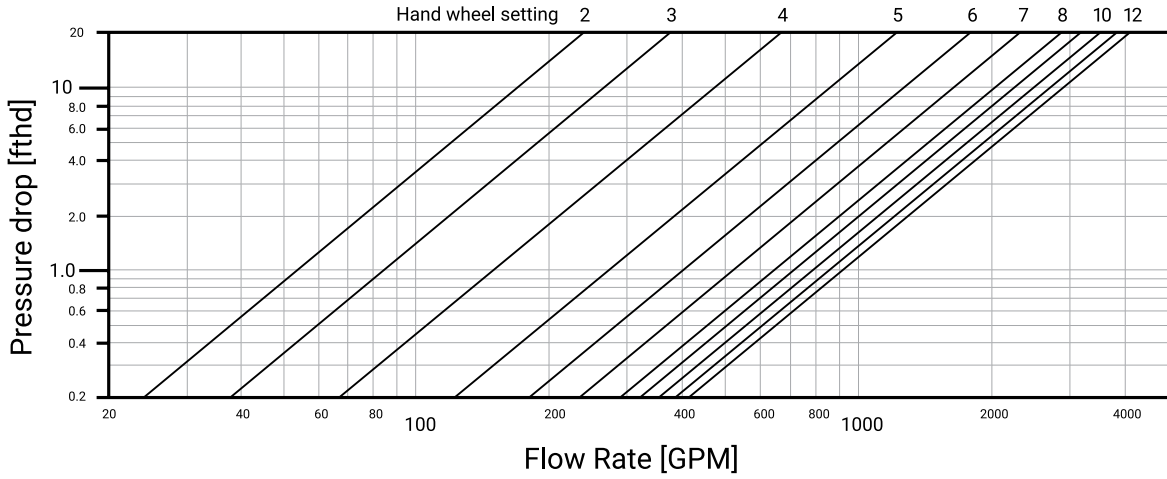

Size: 12"

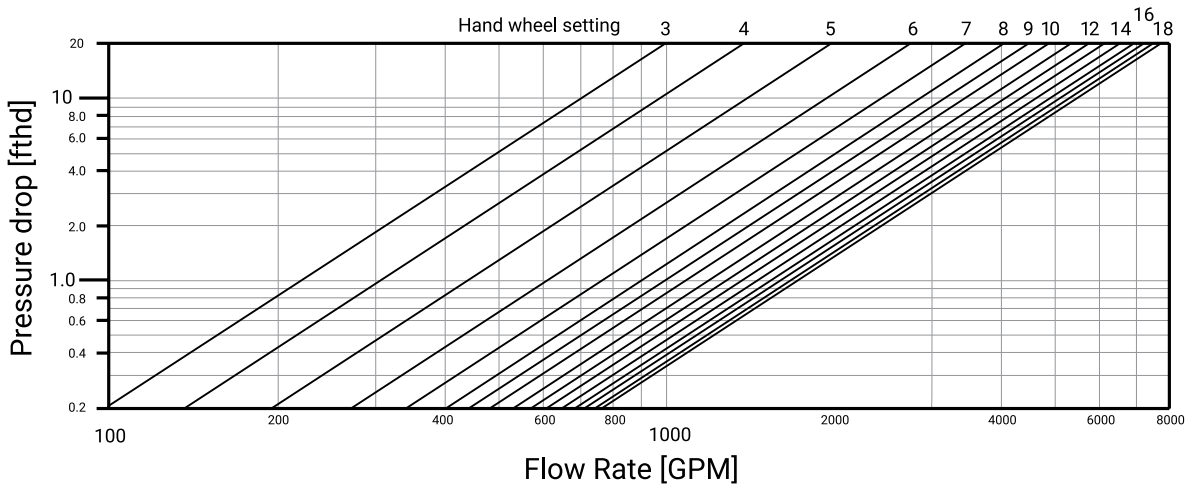

- Introduction
- Couplings
- Outlets
- Fittings
- Valves & Accessories
- High Pressure
- CTS Copper System
- DI-Electric Nipples
- Plan-End Fittings
- HDPE Couplings
- Socket-Fittings
- Stainless Steel Method
- Roll Groovers
- Installation & Assembly
- Special Coatings
- Design Services
- Technical Data
- Master Format 3 Part Specs.
- Pictorial Index

**Tri-Service Valve
Fig. FTV-S (Straight) &
FTV-A (Angle Body)**

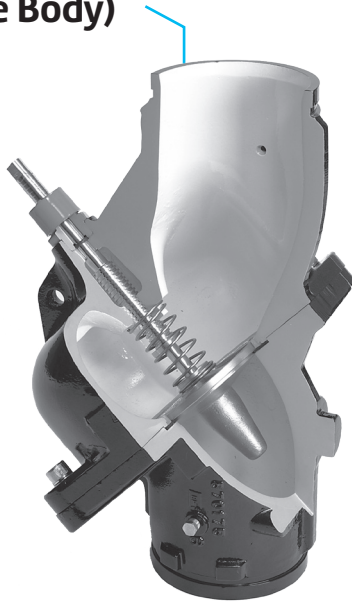

Features & Benefit

- Three functions, one valve –
 1. Spring-closure design,
 2. Non-slam check valve,
 3. Flow throttling valve
- Reduced field installation and material cost
- Stainless steel spring
- High-strength resin seat EPDM for 8" and larger
- Anti-rotation lugs on the inlet and outlet. These lugs, combined with the Gruvlok 7401 Rigidlok Coupling or the Gruvlok flange adapter provides for a ridged rotation free installation
- Flow measurement and pump throttling capabilities
- Temperature measurement capability
- Spring-closure design check valve prevents gravity or reverse circulation when pump is not operating
- Bonnet "O" Ring can be replaced under full system pressure by back seating of valve stem
- Suitable for maximum working pressure to 375 psi (26 bar) and temperatures to 230°F. (110°C)
- Valve seat can be changed in the field without use of special tools
- Low pressure drop due to "Y" pattern valve design
- Valve Cv designed to ASHRAE flow recommendations for quiet system operation
- Drip-tight shut off valve smoke development rating of 50 or less

Service Recommendations

The Model FTV-S & FTV-A Tri-Service Valve is primarily designed for installation in pump discharge piping where it functions as a spring loaded silent check valve, flow control valve and shut off valve.

Operation

The Model FTV Tri-Service Valve operates automatically and silently. Line pressure of approximately ¼ PSI will open the disc. The spring closes the disc as the line flow approaches zero in order to prevent flow reversal & water hammer. The flow through the valve can be adjusted from bubble tight shut off to full flow by the threaded rising stem.

Features

The unique convertible body design permits the valve to be changed on site from the straight to the angle configuration. Flow measurement (where an approximate indication is acceptable) is obtained by flow measuring ports on each side of the valve seat. Pressure differential is easily recorded using differential pressure measurement devices. If precision accuracy is required, we recommend that a Gruvlok Circuit Balancing Valve be installed downstream from the FTV valve.

See Install instructions and flow data on submittal.

Tri-Service Valve Fig. FTV-S (Straight) & FTV-A (Angle Body)

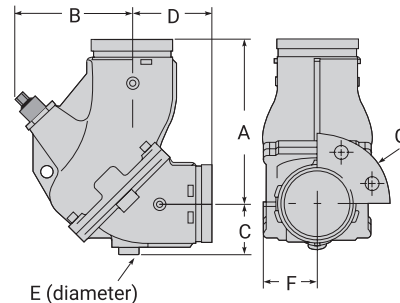
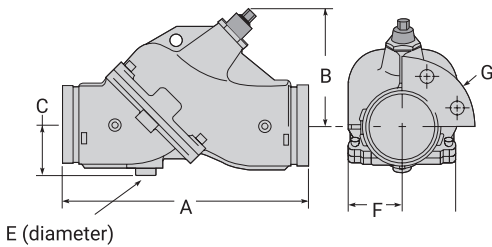

Model FTV-S (Straight)

Connection Size	A	B (fully open)	C	E	F	Flange 125/150 PSI G	Flange 250/300 PSI G	Approx. Wt. Each
	In./mm	In./mm	In./mm	In./mm	In./mm	In./mm	In./mm	Lbs./Kg
2½ 65	12 305	7 178	2¾ 70	1 25	2⅞ 65	7 178	7½ 191	19 9
3 80	12 305	7⅜ 198	2⅞ 62	1 25	3 80	7½ 191	8¼ 210	24 11
4 100	14 356	8 203	3 80	1¼ 32	3⅞ 87	9¼ 235	10 254	42 19
5 125	17½ 445	10⅞ 257	3⅝ 92	1¼ 32	4⅝ 125	10 254	11 279	81 37
6 150	20⅞ 525	10¾ 264	4⅞ 113	2 51	5⅞ 149	11 279	12½ 318	120 54
8 200	28¾ 716	22⅜ 579	5⅞ 144	2¼ 57	7⅞ 200	13½ 343	15 381	300 136
10 250	30 762	28⅝ 727	6⅞ 167	2¼ 57	9⅝ 241	16 409	17½ 445	450 204
12 300	38⅞ 967	32⅝ 829	7⅝ 194	2¼ 57	12⅝ 321	19 483	20½ 521	850 390

See previous page for O.D. Size

Material Specifications

Body: Ductile Iron ASTM A 536 Grade 65-45-12

Disc: Bronze ASTM B 584 C-84400

Stem: Stainless Steel ASTM A 582 Type 416

Seat: High Strength Engineered Resin

Spring: Stainless Steel ASTM A 302

"O" Rings: BUNA

Couplings/flanges: Ductile Iron ASTM A 536 Grade 65-45-12 with EPDM² Gaskets (Optional)

Insulation: Optional¹

Note 1: Optional pre-formed insulation is available to meet ASTM D 1784 Class 14253-C, MEA #7-87, ASTM E 136 with a flame spread rating of 25 or less and a smoke development rating of 50 or less.

Note 2: EPDM is not suitable for oil service.

Note: For temperatures between 230°F and 300°F (110°C and 149°C) specify Viton Elastomers

Model FTV-A (Angle)

Connection Size	A	B (fully open)	C	D	E	F	Flange 125/150 PSI G	Flange 250/300 PSI G	Approx. Wt. Each
	In./mm	In./mm	In./mm	In./mm	In./mm	In./mm	In./mm	In./mm	Lbs./Kg
2½ 65	7⅞ 187	7 178	2¾ 70	4⅝ 117	1 25	2⅞ 65	7 178	7½ 191	19 9
3 80	8⅞ 208	7⅜ 198	2⅞ 62	3⅞ 98	1 25	3 80	7½ 191	8¼ 210	24 11
4 100	9⅞ 244	8 203	3 80	4⅞ 111	1¼ 32	3⅞ 87	9¼ 235	10 254	42 19
5 125	12 305	10⅞ 257	3⅝ 92	5½ 140	1¼ 32	8⅝ 125	10 254	11 279	81 37
6 150	14⅞ 359	10¾ 264	4⅞ 113	6⅞ 168	2 51	5⅞ 149	11 279	12½ 318	120 54
8 200	18⅞ 481	18¾ 476	5⅞ 144	9⅞ 233	2¼ 57	7⅞ 200	13½ 343	15 381	300 136
10 250	20⅝ 516	24 610	6⅞ 167	9¾ 248	2¼ 57	9⅝ 241	16 409	17½ 445	450 204
12 300	24⅞ 611	26¼ 667	7⅞ 194	14 356	2¼ 57	12⅝ 321	19 483	20½ 521	860 390

See previous page for O.D. Size

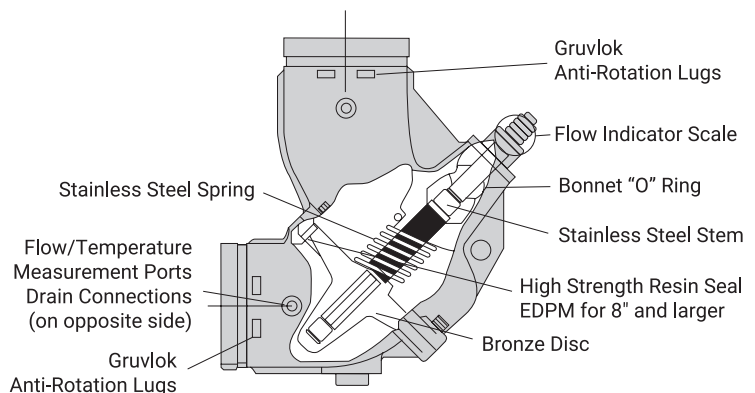

Grooved-End "Wye" Strainer Model 758G

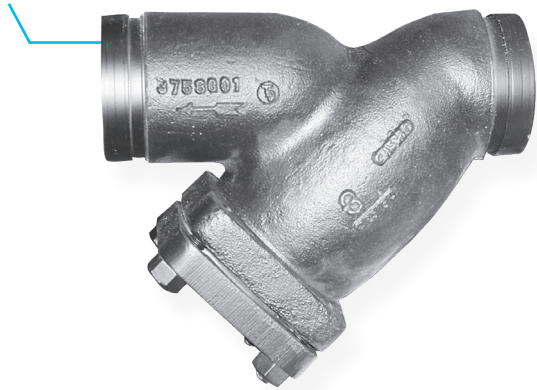

Material Specifications

Body & Cover

Ductile Iron ASTM A 395
Grade 60-40-18

Flat Gaskets

Non-asbestos

Screen

2" - 4" Type 304 Stainless Steel 1/16"
(1.6mm) dia. holes (12 mesh)

5" - 12" Type 304 Stainless Steel 1/8"
(3.2mm) dia. holes (6 mesh)

Special order screen option:

2" - 8" - 16 mesh / 10" - 12" - 12 mesh

Coupling

Ductile iron ASTM A 536
Grade 65-45-12

Service Recommendations

For use in water, oil and gas piping to provide economical protection for pumps, meters, valves, compressors, traps and similar equipment.

Screens

Standard screens for Y-Strainer are perforated 304 Stainless Steel with spot welded seam. Mesh lining is available in all alloys for extra fine straining. Recommended standard perforations are listed below in the Material Specifications.

Gruvlok Strainer Basket

Furnished as standard in sizes 8" (43 mm) and larger. A one-quarter turn securely locks the screen in its seat and frees the serviceman for securing the cover flange to the body of the strainer.

Contact an ASC Engineered Solutions Representative for other applications.

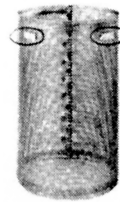

Construction

All covers have an NPT blowoff outlet at location "C". A recessed seat in the cover ensures accurate screen alignment. Bosses at the inlet and outlet flanges are provided for gauge taps.

Self-cleaning is done by opening the valve or plug connected to the blowoff outlet. (When ordering, advise when strainers are to be mounted in vertical piping, the cover can be rotated to position the blowoff at the lowest point.)

Blowoff Outlets

Tapped NPT size specified in the dimension table. Blowoff outlets are not normally furnished with plugs.

Individually Hydrostatically Tested

Working Pressures Non-Shock

640 PSI @ 150°F (45 Bar @ 65°C)

Grooved-End "Wye" Strainer Model 758G

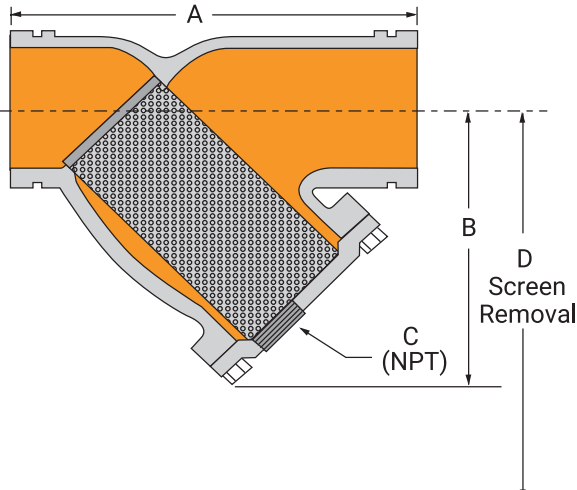

Flow Data

NOTE 1 Most U.S. piping engineers specify system startup instructions for new systems which include removing the pre-filter screen after system flushing of the main piping before the system is put into normal operation. Flow data values are based on flow of clean water at ambient temperatures. The pressure drop across the diffuser basket strainer, 50% clogged, is approximately twice as great as that of a clean strainer.

NOTE 2 Suction Diffuser baskets need a routine maintenance program to maintain system efficiency.

Fig. 758 G Grooved-End "Wye" Strainer

Nominal Size	O.D.	Dimensions				Approx. Wt. Ea.
		A	B	C Plug Size	D	
In./DN(mm)	In./mm	In./mm	In./mm	In./mm	Lbs./Kg	Lbs./Kg
2	2.375	7 ⁷ / ₈	5 ¹ / ₄	1 ¹ / ₂	7	12.0
50	60.3	200	133	25	178	5.4
2 ¹ / ₂	2.875	10	6 ¹ / ₂	1	9 ³ / ₄	18.0
65	73.0	254	165	25	248	8.2
3	3.500	10 ¹ / ₈	7	1	10	23.0
80	88.9	257	178	25	254	10.4
4	4.500	12 ¹ / ₈	8 ³ / ₄	1 ¹ / ₂	12	42.0
100	114.3	308	210	38	305	19.1
5	5.563	15 ⁵ / ₈	11 ¹ / ₄	2	17	80.0
125	141.3	396	286	51	432	36.3
6	6.625	18 ¹ / ₂	13 ¹ / ₂	2	20	112.0
150	168.3	470	343	51	508	50.8
8	8.625	21 ⁵ / ₈	15 ¹ / ₂	2	22 ³ / ₄	205.0
200	219.1	549	394	51	577	93.0
10	10.750	25 ³ / ₄	18 ¹ / ₂	2	28	277.0
250	273.1	654	470	51	711	125.6
12	12.750	30	21 ³ / ₄	2	30	470.0
300	323.9	762	552	51	762	213.2

*Maximum working pressure is based upon the performance capability of the Gruvlok Strainer. Maximum system working pressure is dependant upon the couplings used for installation and the pressure capacity of other system components.

Not for use with copper systems.

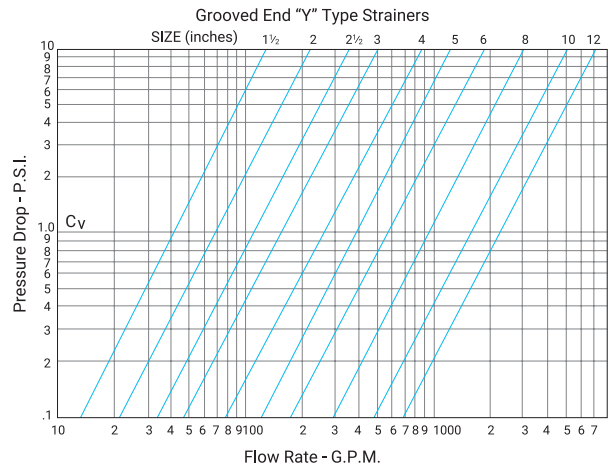

- Introduction
- Couplings
- Outlets
- Fittings
- Valves & Accessories
- High Pressure
- CTS Copper System
- DI-Electric Nipples
- Plan-End Fittings
- HDPE Couplings
- Socket-Fittings
- Stainless Steel Method
- Roll Groovers
- Installation & Assembly
- Special Coatings
- Design Services
- Technical Data
- Master Format 3 Part Specs.
- Pictorial Index

Grooved-end "Wye" Strainer Model 768G



Values for flow of water at +60°F (+16°C)

$$C_v = \frac{Q}{\sqrt{\Delta P}}$$

Where:
Q = Flow (GPM)
C_v = flow coefficient
ΔP = Pressure drop (PSI)

Grooved-end Wye-Strainers are designed to strain debris and foreign matter from piping systems and thus provide inexpensive protection for costly pumps, meters and other components. The Strainer can be installed quickly and easily with two mechanical couplings and the straight flow through design provides for lower pressure drop. This strainer features a stainless steel screen that is secured with an end cap and mechanical coupling. Cleaning and maintenance of the screen can be accomplished easily by removing the coupling. The Strainer is suitable for vertical and horizontal installations.

Material Specifications

Body

Ductile iron ASTM A 536 Grade 65-45-12

End Cap

Ductile iron ASTM A 536 Grade 65-45-12

Screen

2" - 3" Type 304 Stainless Steel to ASTM A 240
1/16" (1.6 mm) perforations (12 mesh)

4" - 12" Type 304 Stainless Steel to ASTM A 240
1/8" (3.2 mm) perforations (6 mesh)

Coupling

Ductile iron ASTM A 536 Grade 65-45-12

Gasket

EPDM Temperature range -40°F - +230°F
(-40° to 110°C) - Standard

Nitrile Temperature range -20°F to 180°F
(-29° to 82°C) - Special Request

Blow Down Port

2" - 5": 1" tapped with plug,

6" - 12": 1½" tapped with plug

Strainer baskets need a routine maintenance program to maintain efficiency and to prevent excess pressure drop caused by a clogged screen.

Grooved-end "Wye" Strainer Model 768G

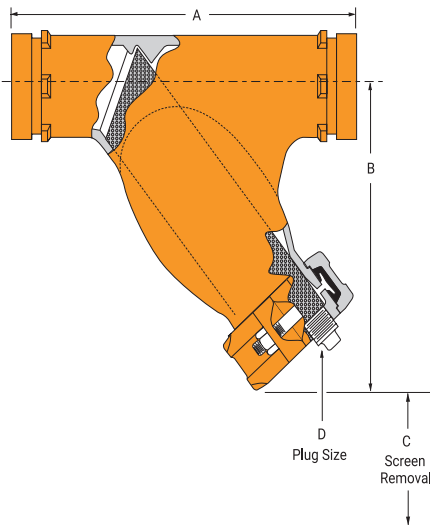

Nominal Size	O.D.	Working Pressure	Dimensions				D Plug Size	Cv Values	Approx. Wt. Ea.
			A	B	C				
In./DN(mm)	In./mm	PSI/bar	In./mm	In./mm	In./mm	In./mm		Lbs./Kg	
2	2.375	300	9 ³ / ₄	6 ³ / ₄	4 ⁷ / ₈	1	59	11	
50	60.3	20.7	248	171	124	25		5.0	
2½	2.875	300	10 ³ / ₄	7 ³ / ₈	5¼	1	92	14	
65	73.0	20.7	273	187	133	25		6.4	
3	3.500	300	11¾	8 ³ / ₁₆	5 ⁷ / ₈	1	162	20	
80	88.9	20.7	298	208	149	25		9.1	
4	4.500	300	14¼	10	7½	1	284	32	
100	114.3	20.7	362	254	191	25		14.5	
5	5.563	300	16½	11¼	8¼	1	410	46	
125	141.3	20.7	419	286	210	25		20.9	
6	6.625	300	18½	13 ³ / ₈	9 ⁷ / ₈	1½	770	70	
150	168.3	20.7	470	340	251	38		31.8	
8	8.625	300	24	16¾	12 ⁵ / ₁₆	1½	1010	155	
200	219.1	20.7	610	425	313	38		70.3	
10	10.750	300	27	19	13 ¹¹ / ₁₆	1½	1800	230	
250	273.1	20.7	686	483	348	38		104.3	
12	12.750	300	30	22 ¹⁵ / ₁₆	16 ¹¹ / ₁₆	1½	2800	335	
300	323.9	20.7	762	583	424	38		152.0	

Not for use in copper systems.

- Pressure ratings listed are CWP (cold water pressure) or maximum working pressure within the service temperature range of the gasket used in the coupling. This rating may occasionally differ from maximum working pressures listed and/or approved by UL, ULC, and/or FM as testing conditions and test pipes differ.
- Maximum working pressure and end loads listed are total of internal and external pressures and loads based on Sch. 40 steel pipe with roll grooves to ANSI C606-97 specifications.
- For one time field test only the maximum joint working pressure may be increased 1½ times the figures shown.
- **WARNING:** Piping systems must always be depressurized and drained before attempting disassembly and or removal of any components.

Tee Strainer
Fig. 7260

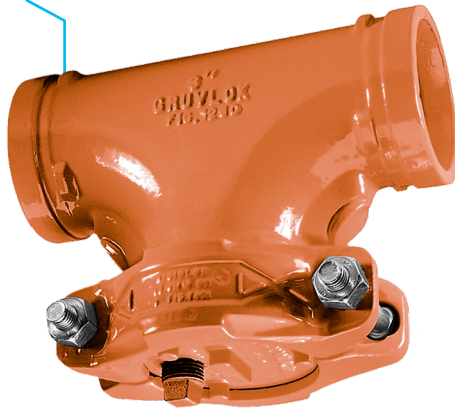

The Fig. 7260 Tee Strainer provides an economical, compact and hydraulically efficient means of protecting valuable piping system components. The in-line, twin-fold strainer basket provides more than 100% of the projected pipe area for open flow through the strainer screen, which results in excellent flow performance across the strainer.

Gruvlok Strainers are designed and tested to ensure long term, reliable service in working pressures up to 750 psi (51.7 bar), depending on size and the pressure rating of the connecting coupling.

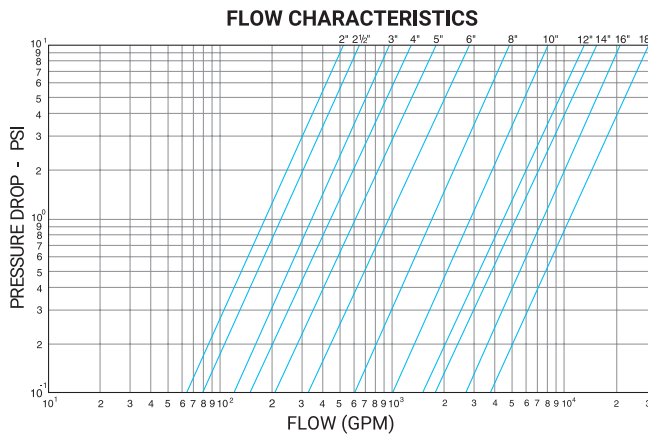

Note: Most U.S. piping engineers specify system startup instructions for new systems which include removing and cleaning the strainer screen after system flushing of main piping before the system is put into normal operation. After flushing, replace the strainer screen. Flow data values are based on flow of clean water at ambient temperatures. The pressure drop across a strainer, 50% clogged, is approximately twice as great as that of a clean strainer. Strainer baskets need a routine maintenance program to maintain efficiency and to prevent excess pressure drop caused by a clogged screen.

Material Specifications

Body

2" - 12" Ductile iron conforming to ASTM A 536, Grade 65-45-12

14" - 18" Carbon steel pipe conforming to ASTM A 53

Strainer Basket

Stainless steel type 304 bar and woven wire screen. 12 mesh in sizes 2" - 3" and 6 mesh in sizes 4" - 18".

Access Coupling & End Cap

2" - 12" Ductile iron conforming to ASTM A 536, Grade 65-45-12

14" - 18" Low carbon steel conforming to ASTM A 53

Bolts

SAE J429, Grade 5, Zinc Electroplated

Heavy Hex Nuts

ASTM A563, Grade A, Zinc Electroplated

Coupling Gaskets

Elastomer properties as designated by ASTM D 2000

Grade "E" EPDM -40°F to +230°F (service temp. range)

Grade "EP" EPDM -40°F to +250°F (service temp. range)

Other options available upon request.

Drain Plug

Carbon steel square head plug conforming to ASME B16.11

Tap Sizes

2"-4" - ½ NPT, 5"-8" - ¾ NPT, 10"-18" - 1 NPT

Coating

2" - 12" - Rust-inhibiting paint — color: orange (standard)

Hot Dip Galvanized conforming to ASTM A 153 (optional)

Other Colors Available (IE: RAL3000 and RAL9000)

For other Coating requirements contact an ASC Engineered Solutions Representative.

Tee Strainer Fig. 7260

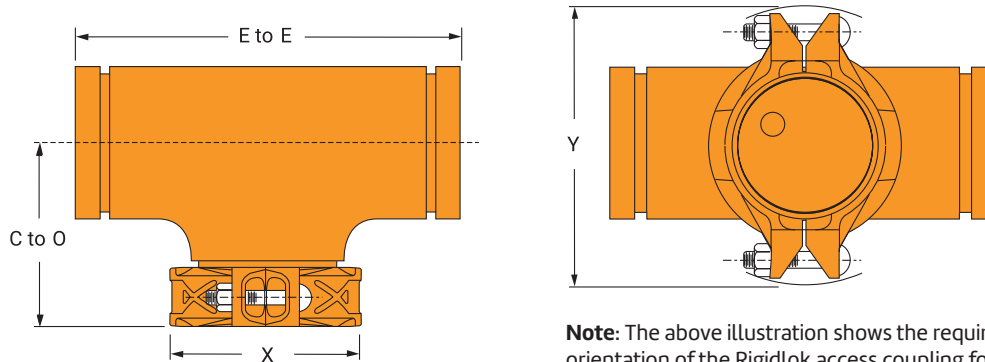

Note: The above illustration shows the required orientation of the Rigidlok access coupling for assembly with a grooved-end flange.

Nominal Size	O.D.	Maximum* Working Pressure	E to E	C to O	X	Y	Basket Removal	Approx. Wt. Ea.
In./DN(mm)	In./mm	PSI/bar	In./mm	In./mm	In./mm	In./mm	Clearance	Lbs./Kg
2	2.375	750	6½	4¼	3½	5⅞	4⅜	6.0
50	60.3	51.7	165	108	89	149	111	2.7
2½	2.875	750	7½	4¾	4	6½	5⅞	8.0
65	73.0	51.7	191	121	102	165	130	3.6
3	3.500	750	8½	5¼	4¾	7	6	13.0
80	88.9	51.7	216	133	121	178	152	5.9
4	4.500	750	10	6⅞	5⅞	8⅞	7¼	19.0
100	114.3	51.7	254	156	149	213	184	8.6
5	5.563	750	11	6⅝	7	10⅞	8¼	30.0
125	141.3	51.7	279	168	178	257	210	13.6
6	6.625	750	13	7⅝	8⅞	11⅞	9¾	45.0
150	168.3	51.7	330	194	206	283	248	20.4
8	8.625	600	15½	9⅞	10½	14⅞	12	79.0
200	219.1	41.4	394	232	267	359	305	35.8
10	10.750	500	18	10⅝	12⅞	17⅞	14¼	133
250	273.1	34.5	457	264	327	435	362	60.3
12	12.750	400	20	11⅝	15	19⅞	16¼	187
300	323.9	27.6	508	289	381	486	413	84.8
14	14.000	300	22	12¾	16⅞	20½	17¼	272
350	355.6	20.7	559	324	410	521	438	123.4
16	16.000	300	24	12	18⅞	22¼	20	350
400	406.4	20.7	610	305	460	565	508	158.8
18	18.000	300	31	15½	20½	24¾	24½	400
450	457.2	20.7	787	394	521	619	622	181.4

* Maximum working pressure is based upon the performance capability of the Gruvlok Strainer. Maximum system working pressure is dependent upon the couplings used for installation and the pressure capability of other system components.

14" - 18" Fabricated

Not for use with copper systems.

Suction Diffuser Fig. 7250

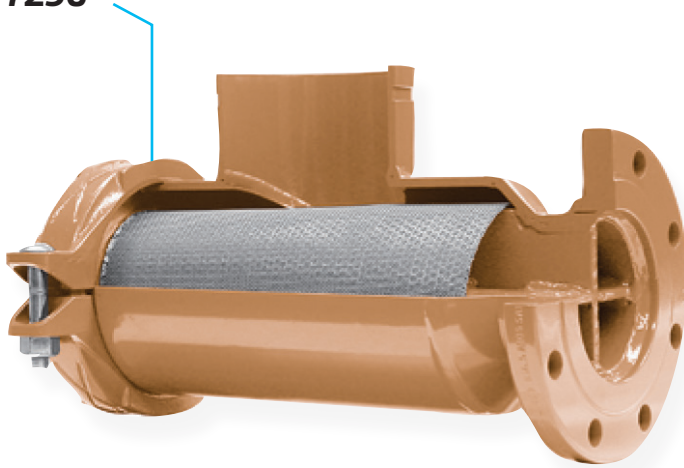

The Fig. 7250 Gruvlok Suction Diffuser protects your pump and saves you money on your overall installed cost while offering you these advantages:

Saves Space: Mounts directly to the pump. Length is ideal for header spacing, reducing the need for additional fittings

Saves Labor & Material: The lightweight compact design is easily installed with no need for welding.

Improves Pump Performance: The one-piece diffuser vane and strainer design reduces flow turbulence, streamlines the flow, and traps any hazardous foreign material to better protect your pump.

Pipe Support Lug Standard

Material Specifications

Bolts: SAE J429, Grade 5, Zinc Electroplated ISO 898-1, Class 8.8, Zinc Electroplated followed by a Yellow Chromate Dip.

Heavy Hex Nuts: ASTM A563, Grade A, Zinc Electroplated ISO 898-2, Class 8.8, Zinc Electroplated followed by a Yellow Chromate Dip.

Stainless Steel Bolts & Nuts: Stainless steel bolts and nuts are also available. Contact an ASC Representative for more information.

Housing:

Sizes 2½" x 2½" through 10" x 8": Carbon steel Schedule 40 conforming to ASTM A 53, Grade B.

Sizes 10" x 10" through 16" x 14": Carbon steel .375" standard weight wall conforming to ASTM A 53, Grade B.

Diffuser Basket:

Stainless steel type 304, #16 perforated plate with ⅜" diameter holes. (51% open area). Pre-Filter: Stainless steel type 304 screen - 16 mesh. (removable).

Material Specifications (Continued)

Couplings: Ductile Iron conforming to ASTM A 536, Grade 65-45-12.

Flanges: Carbon steel class 150# conforming to ASME B 16.5.

Drain and Cage Plugs: Carbon steel square head plugs conforming to ASME B16.11.

Coatings: Rust inhibiting paint Color: ORANGE (standard).

Gaskets: Materials

Properties as designated in accordance with ASTM D 2000.

Grade "E" EPDM (Green color code)

-40°F to 230°F (Service Temperature Range) (-40°C to 110°C) Recommended for water service, diluted acids, alkalies solutions, oil-free air and many other chemical services.

NOT FOR USE IN PETROLEUM APPLICATIONS.

Grade "EP" EPDM (Green and Red color code)

-40°F to 250°F (Service Temperature Range) (-40°C to 121°C) Recommended for water service, diluted acids, alkalies solutions, oil-free air and many other chemical services.

NOT FOR USE IN PETROLEUM APPLICATIONS.

For hot water applications the use of Gruvlok Extreme Temperature lubricant is recommended. NSF-61 Certified for cold and hot water applications up through 12".

Grade "T" Nitrile (Orange color code)

-20°F to 180°F (Service Temperature Range) (-29°C to 82°C).

Recommended for petroleum applications air with oil vapors and vegetable and mineral oils.

NOT FOR USE IN HOT WATER OR HOT AIR.

Suction Diffuser Fig. 7250

Flow Data

Note 1:

Most U.S. piping engineers specify system startup instructions for new systems which include removing the pre-filter screen after system flushing of the main piping before the system is put into normal operation. Flow data values are based on flow of clean water at ambient temperatures. The pressure drop across the diffuser basket strainer, 50% clogged, is approximately twice as great as that of a clean strainer.

Note 2:

Suction Diffuser baskets need a routine maintenance program to maintain system efficiency.

Fig. 7250 Suction Diffuser Nominal Pressure Loss Vs. Flow

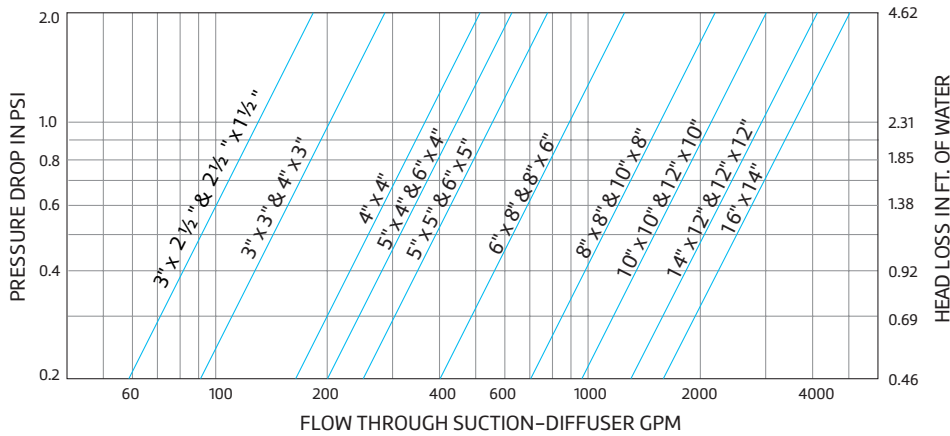

- Introduction
- Couplings
- Outlets
- Fittings
- Valves & Accessories
- High Pressure
- CTS Copper System
- Di-Electric Nipples
- Plan-End Fittings
- HDPE Couplings
- Sock-It® Fittings
- Stainless Steel Method
- Roll Croovers
- Installation & Assembly
- Special Coatings
- Design Services
- Technical Data
- Master Format 3 Part Specs.
- Pictorial Index

Suction Diffuser Fig. 7250

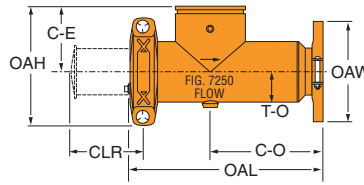

Sizes 2½" X 2½" thru 16" x 14"

Fig. 7250 Suction Diffuser

Nominal Size	O.D.	System Side (Grooved)	Pump Side (Flanged)	C-E	C-O	OAL	OAH	OAW Flange O.D.	CLR	T-O	Orifice Cylinder Open Area	Max. Working Pressure	Approx. Wt. Each
In./DN(mm)	In./mm	In./DN(mm)	In./DN(mm)	In./mm	In./mm	In./mm	In./mm	In./mm	In./mm	In./mm	In. Sq./cm. Sq.	PSI/bar	Lbs./Kg
2½ x 2½	2.875 x 2.875	2½	2½	5	8	13½	9	7	13½	2¼	48	300	32
65 x 65	73.0 x 73.0	65	65	127	203	343	229	178	343	57	310	20.7	14.5
3 x 2	3.500 x 2.375	3	2	5	8	13½	9	6	13½	2¼	42	300	34
80 x 50	88.9 x 60.3	80	50	127	203	343	229	152	343	57	271	20.7	15.4
3 x 2½	3.500 x 2.875	3	2½	5	8	13½	9	7	13½	2¼	48	300	34
80 x 65	88.9 x 73.0	80	65	127	203	343	229	178	343	57	310	20.7	15.4
3 x 3	3.500 x 3.500	3	3	5	8	13½	9	7½	10¼	2⅜/16	58	300	35
80 x 80	88.9 x 88.9	80	80	127	203	343	229	191	260	71	374	20.7	15.9
4 x 2	4.500 x 2.375	4	2	5	8	13½	9	6	13½	2¼	48	300	35
100 x 50	114.3 x 60.3	100	50	127	203	343	229	152	343	57	310	20.7	15.9
4 x 2½	4.500 x 2.875	4	2½	5	8	13½	9	7	13½	2¼	48	300	36
100 x 65	114.3 x 73.0	100	65	127	203	343	229	178	343	57	310	20.7	16.3
4 x 3	4.500 x 3.500	4	3	5	8	13½	9	7½	10¼	2⅜/16	58	300	37
100 x 80	114.3 x 88.9	100	80	127	203	343	229	191	260	71	374	20.7	16.8
4 x 4	4.500 x 4.500	4	4	6½	10½	17½	11¾	9	13½	3⅜/16	94	300	70
100 x 100	114.3 x 114.3	100	100	165	267	445	298	229	343	84	607	20.7	31.8
5 x 4	5.563 x 4.500	5	4	6½	10½	17½	11¾	9	13½	3⅜/16	94	300	72
125 x 100	141.3 x 114.3	125	100	165	267	445	298	229	343	84	607	20.7	32.7
5 x 5	5.563 x 5.563	5	5	6½	10½	17½	13¾	10	13½	4⅜/16	117	300	75
125 x 125	141.3 x 141.3	125	125	165	267	445	349	254	343	110	755	20.7	34.0
6 x 3	6.625 x 3.500	6	3	6½	10½	17½	11¾	7½	13½	3⅜/16	94	300	72
150 x 80	168.3 x 88.9	150	80	165	267	445	298	191	343	84	607	20.7	34.0
6 x 4	6.625 x 4.500	6	4	6½	10½	17½	11¾	9	13½	3⅜/16	94	300	73
150 x 100	168.3 x 114.3	150	100	165	267	445	298	229	343	84	607	20.7	33.1
6 x 5	6.625 x 5.563	6	5	6½	10½	17½	13¾	10	13½	4⅜/16	117	300	75
150 x 125	168.3 x 141.3	150	125	165	267	445	349	254	343	110	755	20.7	34.0
6 x 6	6.625 x 6.625	6	6	7¾	13¾	21½	14¾	11	16¼	4⅜/16	167	300	120
150 x 150	168.3 x 168.3	150	150	197	337	546	375	279	413	110	1,077	20.7	54.4
8 x 5	8.625 x 5.563	8	5	7¾	13¾	21½	14¾	10	16¼	4⅜/16	167	300	128
200 x 125	219.1 x 141.3	200	125	197	337	546	375	254	413	110	1,077	20.7	58.1
8 x 6	8.625 x 6.625	8	6	7¾	13¾	21½	14¾	11	16¼	4⅜/16	167	300	130
200 x 150	219.1 x 168.3	200	150	197	337	546	375	279	413	110	1,077	20.7	59.0
8 x 8	8.625 x 8.625	8	8	9	15¼	24½	17¾	13½	19¾	5⅜	266	300	190
200 x 200	219.1 x 219.1	200	200	229	387	622	451	343	502	137	1,716	20.7	86.2
10 x 6	10.750 x 6.625	10	6	9	15¼	24½	17½	11	19¾	5⅜	266	300	195
250 x 150	273.1 x 168.3	250	150	229	387	622	445	279	502	137	1,716	20.7	88.5
10 x 8	10.750 x 8.625	10	8	9	15¼	24½	17½	13½	19¾	5⅜	266	300	200
250 x 200	273.1 x 219.1	250	200	229	387	622	445	343	502	137	1,716	20.7	90.7
10 x 10	10.750 x 10.750	10	10	10	17¼	28	19⅞	16	23¾	6⅜	384	300	225
250 x 250	273.1 x 273.1	250	250	254	438	711	498	406	603	162	2,477	20.7	102.1
12 x 8	12.750 x 8.625	12	8	10	17¼	28	19⅞	13½	23¾	6⅜	384	300	225
300 x 200	323.9 x 219.1	300	200	254	438	711	498	343	603	162	2,477	20.7	102.1
12 x 10	12.750 x 10.750	12	10	10	17¼	28	19⅞	16	23¾	6⅜	384	300	230
300 x 250	323.9 x 273.1	300	250	254	438	711	498	406	603	162	2,477	20.7	104.3
12 x 12	12.750 x 12.750	12	12	11	24¼	36	20¼	19	34¼	8	695	300	382
300 x 300	323.9 x 323.9	300	300	279	616	914	521	483	870	203	4,484	20.7	173.3
14 x 10	14.000 x 10.750	14	10	11	24¼	36	20¼	16	34¼	8	695	300	382
350 x 250	355.6 x 273.1	350	250	279	616	914	521	406	870	203	4,484	20.7	173.3
14 x 12	14.000 x 12.750	14	12	11	24¼	36	20¼	19	34¼	8	695	300	382
350 x 300	355.6 x 323.9	350	300	279	616	914	521	483	870	203	4,484	20.7	173.3
14 x 14	14.000 x 14.000	14	14	12	26¼	39	23	21	36	9	817	300	467
350 x 350	355.6 x 355.6	350	350	305	667	991	584	533	914	229	5,271	20.7	211.8
16 x 14	16.000 x 14.000	16	14	12	26¼	39	23	21	36	9	817	300	467
400 x 350	406.4 x 355.6	400	350	305	667	991	584	533	914	229	5,271	20.7	211.8

Other sizes available on special request. Contact an ASC Rep. for ordering information. Dimensions may vary Contact an ASC Rep. for certified values. Not for use in copper systems. Product must be supported by pipe supports (supports not included).

- "CLR" Dimension indicates clearance needed for diffuser basket removal.
- Drain Holes: (End Cap) -¾" NPT for sizes 2½ x 2½ thru 6 x 5, -1" NPT for sizes 6 x 6 thru 16 x 14.
- Pipe Support - Use 1¼" SCH. 40 Pipe for 2½" thru 10" pipe and 2" SCH. 40 Pipe for 12" and larger diffusers.
- "Orifice Cylinder Open Area" is the total area of the opening in the diffuser basket after the pre-fitter screen has been removed.

Suction Diffuser
Fig. S810

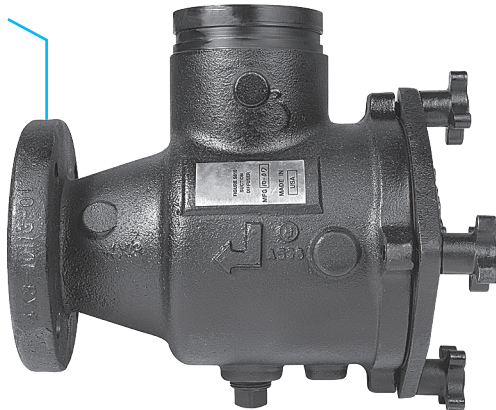

The Figure S810 Suction Diffuser is compact and rugged for direct mounting to the suction side of a pump in either a horizontal or vertical position. In addition to removing foreign particles, the Figure S810 also provides proper flow conditions to the pump. Where space is limited, the Figure S810 can be used to replace the straight pipe normally required to reduce turbulence. The Figure S810 Suction Diffuser can be used for primary or additional strainer protection, especially for controls, meters and other rotating equipment.

The Figure S810 Suction Diffuser's permanent perforated stainless steel screen helps remove foreign particles. The inlet end is suitable for installation with Gruvlok couplings. The outlet end is provided with a Class 150 ANSI flat face flange. The large 5 to 1 open area ratio and the blow-off mean minimum servicing with easy draining and flushing. Quick opening knobs minimize down time on sizes 3 in. x 2 in. thru 10 in. x 8 in. (larger sizes are provided with stud/nut arrangement). Sealing between body and cover is accomplished by using an EPDM O-ring. Straightening vanes in the diffuser outlet reduce turbulence so that stress and erosion on the pump is minimized.

The Figure S810 Suction Diffuser is designed with special support pads that fit the I.D. of standard pipe. This relieves the stress on hangers and inlet piping and eliminates the need for a pipe saddle for mounting. The Figure S810 also has provisions for NPT gauge taps on both the inlet and outlet sides of the diffuser (drilling and tapping should be specified when ordering) along with a plugged NPT drain connection provided at the bottom.

The Figure S810 Suction Diffuser comes equipped with a removable, fine mesh start-up sleeve around the permanent perforated screen. The sleeve should be removed after the start-up period and discarded.

Material Specifications

Body and Cover

Ductile iron conforming to ASTM A 126B

Knobs

Ductile iron conforming to ASTM A 536, Grade 65-45-12 for sizes 3" x 2" thru 10" x 8" (80mm x 50mm thru 250mm x 200mm)
Stud/nuts carbon steel conforming to ASTM A 193- 4, for sizes 10" x 10" (250mm x 250mm) and larger

Screen

- 5/32" (4.0mm) perforated type 304 stainless steel for sizes 3" x 2" thru 6" x 6" (80mm x 50mm thru 150mm x 150mm);
- 1/8" (3.2mm) perforated type 304 stainless steel for sizes 8" x 5" (200 x 125mm) and larger
- Sleeve is 20 mesh type 304 stainless steel

Coating

Black enamel paint

Maximum Working Pressure

300 psi (20.7 bar) at 100°F (38°C)
165 psi (11.4 bar) at 300°F (149°C)

Note: Pressure and temperature can be limited by O-ring material.

Contact an ASC Engineered Solutions Sales Representative.

- Introduction
- Couplings
- Outlets
- Fittings
- Valves & Accessories
- High Pressure
- CTS Copper System
- DI-Electric Nipples
- Plan-End Fittings
- HDPE Couplings
- Socket-It® Fittings
- Stainless Steel Method
- Roll Groovers
- Installation & Assembly
- Special Coatings
- Design Services
- Technical Data
- Master Format 3 Part Specs.
- Pictorial Index

Suction Diffuser
Fig. S810

Fig. S810 Suction Diffuser Nominal Pressure Loss Vs. Flow

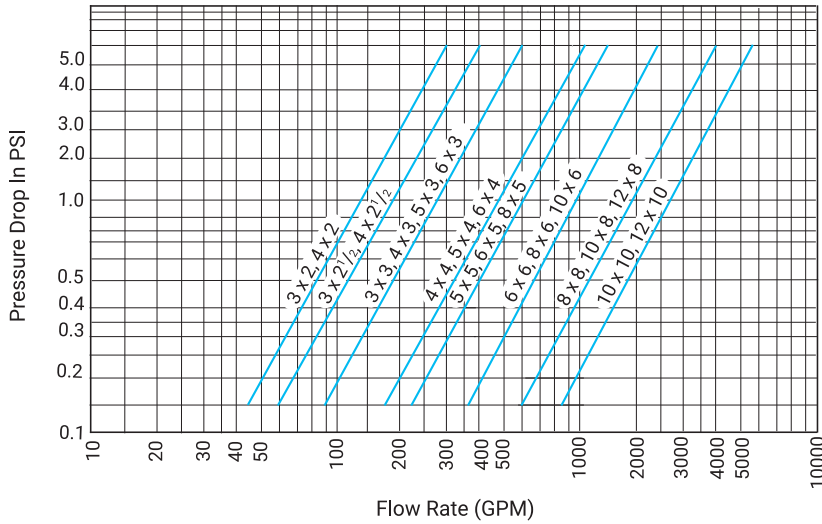

Note: It is good piping practice to apply a safety factor of 15% to 20% to the values in the above table for design purposes.

Suction Diffuser Fig. S810

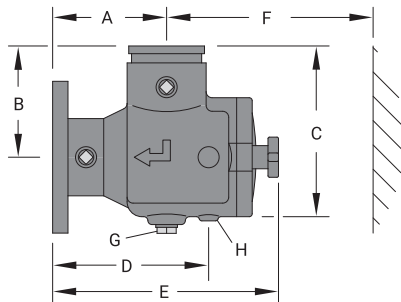

Valve Size	O.D.	Dimensions								Approx. Wt. Ea.
		A	B	C	D	E	F Screen Removal	G Plug (NPT)	H Pipe Support I.D.	
In./mm	In./mm	In./mm	In./mm	In./mm	In./mm	In./mm	In./mm	In./mm	In./mm	Lbs./Kg
2 x 2 50 x 50	2.375 x 2.375 60.3 x 60.3	4.50 114.3	4.50 114.3	6.69 169.9	6.13 155.7	10.19 258.8	8.81 223.80	0.75 20	0.824 20.9	19 8.6
2½ x 2 65 x 50	2.875 x 2.375 73.0 x 60.3	5.00 127.0	5.00 127.0	7.50 190.5	6.56 166.6	10.88 276.4	9.13 231.90	0.75 20	1.38 35.1	20 9.1
2½ x 2½ 65 x 65	2.875 x 2.875 73.0 x 73.0	5.00 127.0	5.00 127.0	7.50 190.5	6.56 166.6	10.88 276.4	9.13 231.90	0.75 20	1.38 35.1	22 10.0
3 x 2 80 x 50	3.500 x 2.375 88.9 x 60.3	5.50 139.7	5.50 139.7	8.44 214.4	7.38 187.5	11.56 293.6	9.63 244.60	0.75 20	1.38 35.1	38.0 17.2
3 x 2½ 80 x 65	3.500 x 2.875 88.9 x 73.0	5.50 139.7	5.50 139.7	8.44 214.4	7.38 187.5	11.56 293.6	9.63 244.60	0.75 20	1.38 35.1	39.0 17.7
3 x 3 80 x 80	3.500 x 3.500 88.9 x 88.9	5.50 139.7	5.50 139.7	8.44 214.4	7.38 187.5	11.56 293.6	9.63 244.60	0.75 20	1.38 35.1	40.0 18.1
4 x 2 100 x 50	4.500 x 2.375 114.3 x 60.3	5.75 146.1	5.75 146.1	9.13 231.9	7.63 193.8	11.81 300.0	11.18 284.00	0.75 20	1.38 35.1	48.0 21.8
4 x 2½ 100 x 65	4.500 x 2.875 114.3 x 73.0	6.50 165.1	6.50 165.1	10.48 266.2	8.75 222.3	13.13 333.5	9.63 244.60	1.00 25	1.38 35.1	49.0 22.2
4 x 3 100 x 80	4.500 x 3.500 114.3 x 88.9	6.50 165.1	6.81 173.0	10.44 265.2	8.75 222.3	13.13 333.5	11.50 292.10	1.00 25	1.38 35.1	50.0 22.7
4 x 4 100 x 100	4.500 x 4.500 114.3 x 114.3	6.50 165.1	6.81 173.0	10.44 265.2	8.75 222.3	13.13 333.5	11.50 292.10	1.00 25	1.38 35.1	52.0 23.6
5 x 3 125 x 80	5.563 x 3.500 141.3 x 88.9	6.50 165.1	6.50 165.1	10.48 266.2	8.75 222.3	13.13 333.5	11.50 292.10	1.00 25	1.38 35.1	94.0 42.6

Continued on next page.

For information on larger sizes contact an ASC Engineered Solutions Sales Representative.

Suction Diffuser Fig. S810

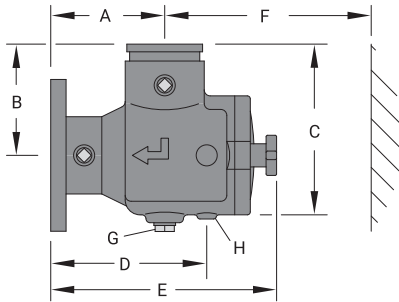

Valve Size	O.D.	Dimensions								Approx. Wt. Ea.
		A	B	C	D	E	F Screen Removal	G Plug (NPT)	H Pipe Support I.D.	
In./mm	In./mm	In./mm	In./mm	In./mm	In./mm	In./mm	In./mm	In./mm	In./mm	Lbs./Kg
5 x 4 125 x 100	5.563 x 4.500 141.3 x 114.3	6.50 165.1	6.50 165.1	11.94 303.3	10.00 254.0	15.75 400.1	14.00 355.60	1.00 25	1.38 35.1	96.0 43.5
5 x 5 125 x 125	5.563 x 5.563 141.3 x 141.3	7.50 190.5	7.50 190.5	11.94 303.3	10.00 254.0	15.75 400.1	14.88 378.00	1.00 25	1.38 35.1	101.0 45.8
6 x 3 150 x 80	6.625 x 3.500 168.3 x 88.9	8.00 203.2	8.00 203.2	13.31 338.1	10.50 266.7	16.88 428.8	16.56 420.60	1.00 25	1.38 35.1	103.0 46.7
6 x 4 150 x 100	6.625 x 4.500 168.3 x 114.3	8.00 203.2	8.00 203.2	13.31 338.1	10.50 266.7	16.88 428.8	16.56 420.60	1.00 25	1.38 35.1	106.0 48.1
6 x 5 150 x 125	6.625 x 5.563 168.3 x 141.3	8.00 203.2	8.00 203.2	13.31 338.1	10.50 266.7	16.88 428.8	16.56 420.60	1.00 25	1.38 35.1	110.0 49.9
6 x 6 150 x 150	6.625 x 6.625 168.3 x 168.3	8.00 203.2	8.00 203.2	13.31 338.1	10.50 266.7	16.88 428.8	16.56 420.60	1.00 25	1.38 35.1	113.0 51.2
8 x 5 200 x 125	8.625 x 5.563 219.1 x 141.3	9.00 228.6	9.00 228.6	14.38 365.0	11.50 292.1	17.88 454.2	16.88 428.80	1.00 25	1.38 35.1	135.0 61.2
8 x 6 200 x 150	8.625 x 6.625 219.1 x 168.3	9.00 228.6	10.00 254.00	15.31 388.9	11.50 292.1	17.88 454.2	16.88 428.80	1.00 25	1.38 35.1	137.0 62.1
8 x 8 200 x 200	8.625 x 8.625 219.1 x 219.1	9.00 228.6	10.00 254.0	16.31 414.3	11.75 298.5	20.75 527.1	22.88 581.20	1.25 32	1.38 35.1	222.0 100.7
10 x 6 250 x 150	10.750 x 6.625 273.1 x 168.3	9.48 240.8	9.48 240.8	15.50 393.7	11.94 303.3	18.31 465.1	16.88 428.80	1.25 32	1.38 35.1	230.0 104.3
10 x 8 250 x 200	10.750 x 8.625 273.1 x 219.1	9.00 228.6	11.75 298.5	18.44 468.4	11.75 298.5	20.75 527.1	22.88 581.20	1.25 32	1.38 35.1	236.0 107.0

Continued on next page.

For information on larger sizes contact an ASC Engineered Solutions Sales Representative.

Suction Diffuser Fig. S810

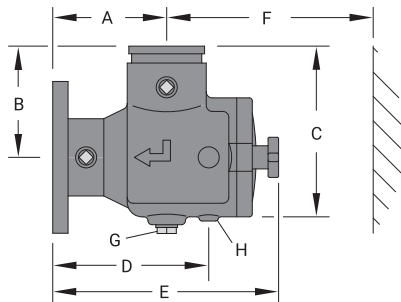

Valve Size	O.D.	Dimensions								Approx. Wt. Ea.
		A	B	C	D	E	F Screen Removal	G Plug (NPT)	H Pipe Support I.D.	
In./mm	In./mm	In./mm	In./mm	In./mm	In./mm	In./mm	In./mm	In./mm	In./mm	Lbs./Kg
10 x 10 250 x 250	10.750 x 10.750 273.1 x 273.1	11.00 279.4	11.75 298.5	20.00 508.0	14.00 355.6	26.38 670.1	30.75 781.10	1.25 32	1.38 35.1	343.0 155.6
12 x 8 300 x 200	12.000 x 8.625 323.9 x 219.1	9.00 228.6	9.00 228.6	19.63 498.6	11.75 298.5	20.75 527.1	22.88 581.20	1.25 32	1.38 35.1	357.0 161.9
12 x 10 300 x 250	12.000 x 10.750 323.9 x 273.1	11.00 279.4	12.88 327.2	21.00 533.4	14.00 355.6	26.38 670.1	30.75 781.10	1.25 32	1.38 35.1	357.0 161.9
12 x 12 300 x 300	12.000 x 12.000 323.9 x 323.9	12.00 304.8	12.00 304.8	22.06 560.3	15.25 387.4	26.18 665.0	30.75 781.10	1.25 32	1.38 35.1	357.0 161.9
14 x 10 350 x 250	14.000 x 10.750 355.6 x 273.1	11.00 279.4	11.00 279.4	22.50 571.5	14.00 355.6	26.38 670.1	30.75 781.10	1.25 32	1.38 35.1	507.0 229.9
14 x 12 350 x 300	14.000 x 12.000 355.6 x 323.9	12.00 304.8	12.00 304.8	22.38 568.5	15.25 387.4	26.18 665.0	31.00 787.40	1.25 32	1.38 35.1	601.0 272.6
14 x 14 350 x 350	14.000 x 14.000 355.6 x 355.6	14.00 355.6	14.00 355.6	25.00 635.0	17.50 444.5	27.75 704.9	33.13 841.50	2.00 50	1.38 35.1	706.0 320.2
16 x 14 400 x 350	16.000 x 14.000 406.4 x 355.6	14.00 355.6	14.00 355.6	26.00 660.4	17.50 444.5	27.88 708.2	31.00 787.40	2.00 50	1.38 35.1	750.0 340.1

For information on larger sizes contact an ASC Engineered Solutions Sales Representative.

- Introduction
- Couplings
- Outlets
- Fittings
- Valves & Accessories
- High Pressure
- CTS Copper System
- DI-Electric Nipples
- Plan-End Fittings
- HDPE Couplings
- Socket-It® Fittings
- Stainless Steel Method
- Roll Groovers
- Installation & Assembly
- Special Coatings
- Design Services
- Technical Data
- Master Format 3 Part Specs.
- Pictorial Index

Automatic Air Vents For Ultimate Performance Model GAV-15



Material Specifications

1. **Body** Cast Iron ASTM A 126, Class B
2. **Cover** Cast Iron ASTM A 126, Class B
3. **Lever Frame** Stainless Steel-T304, ASTM A 240
4. **Seat** Stainless Steel-T303, 582
5. **Float** Stainless Steel-T304, ASTM A 240
6. **Gasket** Non Asbestos
7. **Cover Bolt** Carbon Steel-Sae Grade 5

10. **Float Arm** Stainless Steel-T304, ASTM A 240
11. **Orifice Button** Viton
12. **Pivot Pin** Stainless Steel-T303, 582
13. **Pin Retainer** Stainless Steel-Ph 15-7 MO
14. **Pipe Plug** 1/2" Steel

21. **Locator** Stainless Steel-T304, ASTM F 593

- Two Sizes Equip All Riser Systems
- Spherical Float for Strength
- Stainless Steel Float and Trim
- Special Design Eliminates Blow-by

The Air Vent (GAV) features a Stainless Steel spherical float design. Air in the piping system is vented through the discharge valve that is normally open. Rising water activates the float to close the valve. The valve outlet is tapped to take a safety drain line.

Simplicity of design in the GAV ensures long-lasting efficiency. The Stainless Steel float and valve mechanism involve no wearing parts, and no intricate function. The precision formed cast iron body custom fits the float and valve, and protectively houses their operation under the most demanding conditions.

Max. Working Pressure

175 PSI (12 bar) @ 150° F (66° C)
150 PSI (10 bar) @ 250° F (121° C)

Test Pressure

300 PSI (21 bar) @ 70° F (21° C)

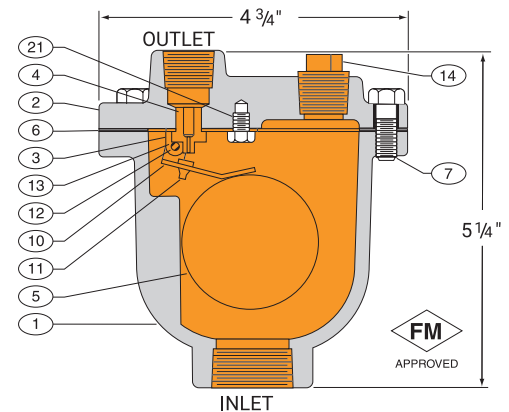

Automatic Air Vents For Ultimate Performance Model GAV-15

Type	Max. Water Pressure	Max. Temp.	Inlet Size	Outlet Size NPT	Valve Orific	Height	Overall		Approx. Wt. Ea
	PSI/bar	°F/°C	In./mm	In./mm	In./mm		Width	Length	
GAV-15	150	250	½, ¾ & 1	¾	⅛	5¼	4¾	4¾	5½
	10	120	15, 20 & 25	10	2	130	100	100	2.5

Valve Size	Maximum Temp.	Inlet Size NPT	Outlet Size NPT	Orific Size	Approx. Wt. Ea
In./mm	°F/°C	In./mm	In./mm	In./mm	Lbs./Kg
½	250	½	½	⅛	5½
15	120	15	15	2	3
¾	250	¾	½	⅛	5½
20	120	20	15	2	3
1	250	1	½	⅛	5½
25	120	25	15	2	3

- Introduction
- Couplings
- Outlets
- Fittings
- Valves & Accessories**
- High Pressure
- CTS Copper System
- DI-Electric Nipples
- Plain-End Fittings
- HDPE Couplings
- Socket-Fittings
- Stainless Steel Method
- Roll Groovers
- Installation & Assembly
- Special Coatings
- Design Services
- Technical Data
- Master Format 3 Part Specs.
- Pictorial Index

Automatic Air Vents for Ultimate Performance Model GAV-30



- Two Sizes Equip All Riser Systems
- Spherical Float for Strength
- Stainless Steel Float and Trim
- Special Design Eliminates Blow-by

The Air Vent (GAV) features a Stainless Steel spherical float design. Air in the piping system is vented through the discharge valve that is normally open. Rising water activates the float to close the valve. The valve outlet is tapped to take a safety drain line.

Simplicity of design in the GAV ensures long-lasting efficiency. The Stainless Steel float and valve mechanism involve no wearing parts, and no intricate function. The precision formed cast iron body custom fits the float and valve, and protectively houses their operation under the most demanding conditions.

Max. Working Pressure

300 PSI

Test Pressure

450 PSI

Material Specifications

- 1. Body:** Cast Iron ASTM A 126, Class B
- 2. Cover:** Cast Iron ASTM A 126, Class B
- 3. Lever Frame:** Stainless Steel ASTM A 240
- 4. Seat:** Stainless Steel-T303, 582
- 5. Float:** Stainless Steel-T304, ASTM A 240
- 6. Gasket:** Non Asbestos
- 7. Cover Bolt:** Alloy Steel ASTM A 449 Grade 5
- 10. Float Arm:** Stainless Steel-T304, ASTM A 240
- 11. Orifice Button:** Viton
- 12. Pivot Pin:** Stainless Steel-T303, 582
- 13. Pin Retainer:** Stainless Steel-Ph 15-7 MO
- 14. Pipe Plug:** Steel
- 17. Float Retainer:** Stainless Steel T304, ASTM F 879
- 21. Locator:** Stainless Steel-T304, ASTM F 593
- 34. Lock Washer:** Stainless Steel T304, ASTM A 240

Note: All specification as last revised

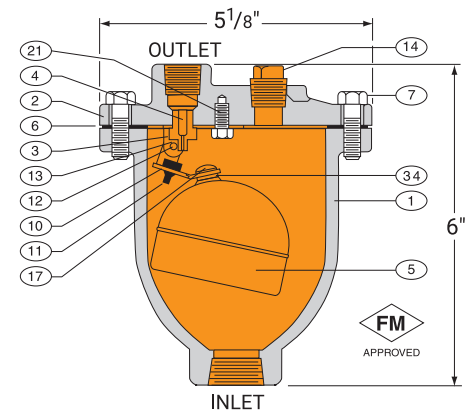

Automatic Air Vents For Ultimate Performance Model GAV-30

Type	Max. Water Pressure	Max. Temp.	Inlet Size	Outlet Size NPT	Valve Orific	Overall			Approx. Wt. Ea
						Height	Width	Length	
	PSI/bar	*F/°C	In./mm	In./mm	In./mm	In./mm	In./mm	In./mm	Lbs./Kg
GAV-30	300 20.7	250 120	1/2, 3/4 & 1 15, 20 & 25	1/2 15	1/16 2	6 150	5 1/8 125	5 1/8 125	7 1/2 3.4

Valve Size	Maximum Temp.	Inlet Size NPT	Outlet Size NPT	Orific Size	Approx. Wt. Each.
In./mm	*F/°C	In./mm	In./mm	In./mm	Lbs./Kg
1/2	250	1/2	1/2	1/16	8
15	120	15	15	2	3
3/4	250	3/4	1/2	1/16	8
20	120	20	15	2	3

- Introduction
- Couplings
- Outlets
- Fittings
- Valves & Accessories**
- High Pressure
- CTS Copper System
- DI-Electric Nipples
- Plain-End Fittings
- HDPE Couplings
- Socket-It® Fittings
- Stainless Steel Method
- Roll Croovers
- Installation & Assembly
- Special Coatings
- Design Services
- Technical Data
- Master Format 3 Part Specs.
- Pictorial Index

AnvilFlex® Flex Connectors Fig. AF-21-GG – Grooved Ends Flex Connector

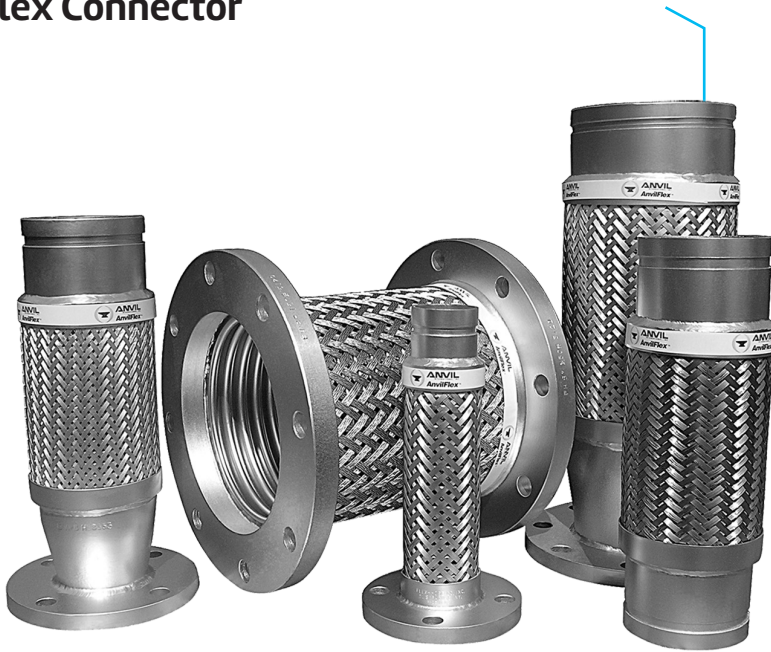

Material Specifications

Hose

300 Series Stainless Steel

Braid

Stainless Steel Type 304

Ends

Schedule 40 Carbon Steel Grooved-Ends

Motion Classifications

AnvilFlex flex connectors are braided pump connectors capable of handling the following movements:

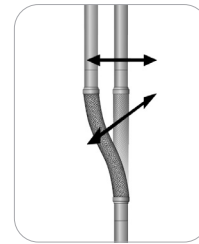

Parallel



Vibration

AnvilFlex Flexible connectors are used to prevent damage to pumps caused by piping stress. AnvilFlex connectors also absorb vibration and noise found in pump installations. AnvilFlex connectors are easily installed and reduce the possibility of pump failure.

They are designed to be pressure tested 1.5 times their maximum rated working pressure and manufactured with a 4:1 safety factor. Their compact design saves valuable space.

See last page for installation instructions.

Working pressure of standard hose and braid up to 1,325 psi (91 bar or full vacuum and operating temperatures of -400°F (-240° C to + 1,500°F 816° C.)

AnvilFlex connectors are manufactured with 321 stainless steel annular corrugated close pitch metal flexible hose. Other stainless steel and corrosion resistant alloys are available. Contact your ASC Engineered Solutions representative for additional information.

Parallel Offset Motion

Motion that occurs when one end of the hose assembly is deflected in a plane perpendicular to the longitudinal axis with the ends remaining parallel. Offset is measured as displacement of the free end centerline from the fixed end centerline.

Motion Frequency

Permanent Offset - The maximum fixed parallel offset to which the corrugated metal hose assembly may be bent without damage. No further motion is to be imposed other than normal vibration.

Intermittent Offset is motion that occurs on a regular or irregular cyclic basis. It is normally the result of thermal expansion and contraction or other non-continuous actions.

NOTE: AnvilFlex flex connectors are manufactured with a 4:1 safety factor.

AnvilFlex® Flex Connectors Fig. AF-21-GG – Grooved Ends Flex Connector

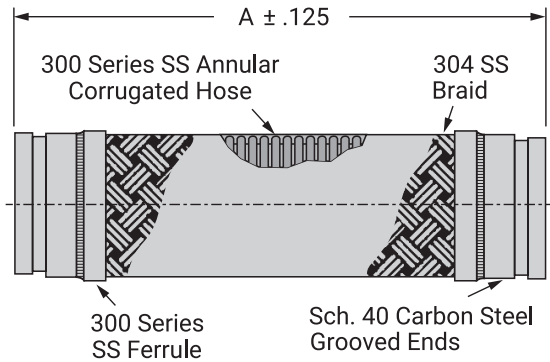

AF-21-GG GRXGR Flex Connectors

Nominal Size In./DN(mm)	O.D. In./mm	Model or 10 dig. #	A In./mm	Pressure 70°F PSI/bar	Parallel Offset		Approx. Wt. Ea. Lbs./kN
					Permanent In./mm	Intermittent In./mm	
2 50	2.375 60.3	AF0390232007	12 304.8	450 31.0	1¼ 31.8	¾ 9.5	2.5 1.1
2½ 65	2.875 73.0	AF0390232106	12 304.8	300 20.7	1¼ 31.8	¾ 9.5	3.5 1.6
3 80	3.500 88.9	AF0390232031	12 304.8	275 19.0	¾ 19.1	¼ 6.4	4.5 2.0
4 100	4.500 114.3	AF0390232114	14 355.6	270 18.6	½ 12.7	¼ 6.4	8.0 3.6
5 125	5.563 141.3	AF0390232122	16 406.4	225 15.5	⅞ 22.2	¾ 9.5	12.0 5.4
6 150	6.625 168.3	AF0390232130	16 406.4	165 11.4	⅝ 15.9	¼ 6.4	14.0 6.4
8 200	8.625 219.1	AF0390232148	16 406.4	155 10.7	½ 12.7	¼ 6.4	20.0 9.1
10 250	10.750 273.1	AF0390232155	20 508.0	150 10.3	⅝ 15.9	¼ 6.4	38.0 17.2
12 300	12.750 323.9	AF0390232163	20 508.0	145 10.0	½ 12.7	¼ 6.4	46.0 20.9

AnvilFlex® Flex Connectors Fig. AF-21-GF – Grooved x Class 150 Flanged Flex Connector



Material Specifications

Hose

300 Series Stainless Steel

Braid

Stainless Steel Type 304

Ends

Schedule 40 Carbon Steel Grooved-end x Class 150 Flanged End

Motion Classifications

AnvilFlex flex connectors are braided pump connectors capable of handling the following movements:

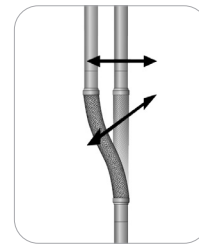

Parallel



Vibration

AnvilFlex Flexible connectors are used to prevent damage to pumps caused by piping stress. AnvilFlex connectors also absorb vibration and noise found in pump installations. AnvilFlex connectors are easily installed and reduce the possibility of pump failure.

They are designed to be pressure tested 1.5 times their maximum rated working pressure and manufactured with a 4:1 safety factor. Their compact design saves valuable space.

See last page for installation instructions.

Working pressure of standard hose and braid up to 1,325 psi (91 bar or full vacuum and operating temperatures of -400°F (-240°C to +1,500°F (816° C).

AnvilFlex connectors are manufactured with 321 stainless steel annular corrugated close pitch metal flexible hose. Other stainless steel and corrosion resistant alloys are available. Contact your ASC Engineered Solutions representative for additional information.

Parallel Offset Motion

Motion that occurs when one end of the hose assembly is deflected in a plane perpendicular to the longitudinal axis with the ends remaining parallel. Offset is measured as displacement of the free end centerline from the fixed end centerline.

Motion Frequency

Permanent Offset - The maximum fixed parallel offset to which the corrugated metal hose assembly may be bent without damage. No further motion is to be imposed other than normal vibration.

Intermittent Offset is motion that occurs on a regular or irregular cyclic basis. It is normally the result of thermal expansion and contraction or other non-continuous actions.

NOTE: AnvilFlex flex connectors are manufactured with a 4:1 safety factor.

AnvilFlex® Flex Connectors Fig. AF-21-GF – Grooved x Class 150 Flanged Flex Connector

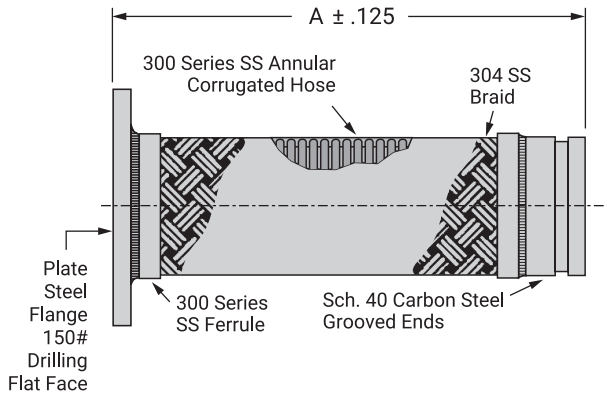

AF-21-GF GRXFL Flex Connectors

Nominal Size	O.D.	Model or 10 dig. #	A	Pressure 70°F	Parallel Offset		Approx. Wt. Ea.
					Permanent	Intermittent	
In./DN(mm)	In./mm		In./mm	PSI/bar	In./mm	In./mm	Lbs./kN
2 50	2.375 60.3	AF0390232197	12 304.8	450 31.0	17/8 47.6	5/8 15.9	7.2 3.3
2½ 65	2.875 73.0	AF0390232213	12 304.8	300 20.7	15/8 41.3	5/8 15.9	8.5 3.9
3 80	3.500 88.9	AF0390232171	12 304.8	275 19.0	11/8 28.6	½ 12.7	10.4 4.7
4 100	4.500 114.3	AF0390232189	12 304.8	270 18.6	5/8 15.9	¼ 6.4	14.0 6.4
5 125	5.563 141.3	AF0390232247	14 355.6	225 15.5	7/8 22.2	3/8 9.5	18.4 8.3
6 150	6.625 168.3	AF0390232254	14 355.6	165 11.4	¾ 19.1	3/8 9.5	23.7 10.8
8 200	8.625 219.1	AF0390232262	15 381.0	155 10.7	5/8 15.9	¼ 6.4	39.6 18.0
10 250	10.750 273.1	AF0390232270	16 406.4	150 10.3	5/8 15.9	¼ 6.4	40 18.1
12 300	12.750 323.9	AF0390232288	17 431.8	145 10.0	½ 12.7	¼ 6.4	50 22.7

AnvilFlex® Flex Connectors Fig. AF-21-FF – Class 150 Flanged X Class 150 Flanged Flex Connector



Material Specifications

Hose

300 Series Stainless Steel

Braid

Stainless Steel Type 304

Ends

Class 150 Flanged Ends

Motion Classifications

AnvilFlex flex connectors are braided pump connectors capable of handling the following movements:

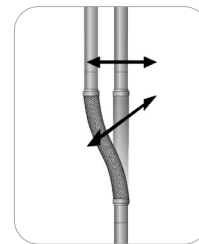

Parallel



Vibration

AnvilFlex Flexible connectors are used to prevent damage to pumps caused by piping stress. AnvilFlex connectors also absorb vibration and noise found in pump installations. AnvilFlex connectors are easily installed and reduce the possibility of pump failure.

They are designed to be pressure tested 1.5 times their maximum rated working pressure and manufactured with a 4:1 safety factor. Their compact design saves valuable space.

See last page for installation instructions.

Working pressure of standard hose and braid up to 1,325 psi (91 bar) or full vacuum and operating temperatures of -400°F (-240° C) to +1,500°F 816° C).

AnvilFlex connectors are manufactured with 321 stainless steel annular corrugated close pitch metal flexible hose. Other stainless steel and corrosion resistant alloys are available. Contact your ASC Engineered Solutions representative for additional information.

Parallel Offset Motion

Motion that occurs when one end of the hose assembly is deflected in a plane perpendicular to the longitudinal axis with the ends remaining parallel. Offset is measured as displacement of the free end centerline from the fixed end centerline.

Motion Frequency

Permanent Offset - The maximum fixed parallel offset to which the corrugated metal hose assembly may be bent without damage. No further motion is to be imposed other than normal vibration.

Intermittent Offset is motion that occurs on a regular or irregular cyclic basis. It is normally the result of thermal expansion and contraction or other non-continuous actions.

NOTE: AnvilFlex flex connectors are manufactured with a 4:1 safety factor.

AnvilFlex® Flex Connectors Fig. AF-21-FF – Class 150 Flanged X Class 150 Flanged Flex Connector

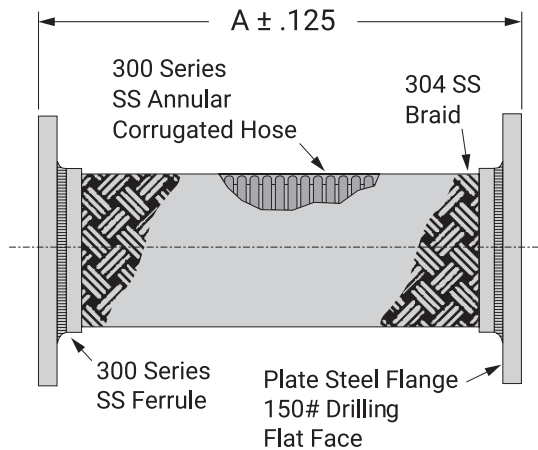

AF-21-FF FLXFL Flex Connectors

Nominal Size In./DN(mm)	O.D. In./mm	Model or 10 dig. #	A In./mm	Pressure 70°F PSI/bar	Parallel Offset		Approx. Wt. Ea. Lbs./kN
					Permanent In./mm	Intermittent In./mm	
2 50	2.375 60.3	AF0390232387	9 228.6	450 31.0	1 1/8 28.6	3/8 9.5	10.0 4.5
2 1/2 65	2.875 73	AF0390232395	9 228.6	300 20.7	1 25.4	3/8 9.5	12.0 5.4
3 80	3.500 88.9	AF0390232403	9 228.6	275 19.0	5/8 15.9	1/4 6.4	14.0 6.4
4 100	4.500 114.3	AF0390232429	9 228.6	270 18.6	1/2 12.7	1/4 6.4	19.0 8.6
5 125	5.563 141.3	AF0390232437	11 279.4	225 15.5	3/4 19.1	3/8 9.5	25.0 11.3
6 150	6.625 168.3	AF0390232445	11 279.4	165 11.4	5/8 15.9	1/4 6.4	30.0 13.6
8 200	8.625 219.1	AF0390232452	12 304.8	155 10.7	1/2 12.7	1/4 6.4	54.0 24.5
10 250	10.750 273.1	AF0390232460	13 330.2	150 10.3	1/2 12.7	1/4 6.4	75.0 34.0
12 300	12.750 323.9	AF0390232478	14 355.6	145 10.0	1/2 12.7	1/4 6.4	105.0 47.6

AnvilFlex® Flex Connectors Fig. AF-21-RFF – Class 150 Flanged x Class 150 Flanged Reducing Flex Connector



Material Specifications

Hose

300 Series Stainless Steel

Braid

Stainless Steel Type 304

Ends

Class 150 Flanged End x Class 150 Reducing Flanged End

Motion Classifications

AnvilFlex flex connectors are braided pump connectors capable of handling the following movements:

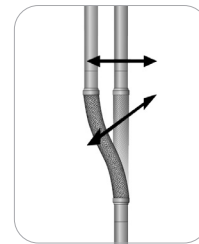

Parallel



Vibration

AnvilFlex Flexible connectors are used to prevent damage to pumps caused by piping stress. AnvilFlex connectors also absorb vibration and noise found in pump installations. AnvilFlex connectors are easily installed and reduce the possibility of pump failure.

They are designed to be pressure tested 1.5 times their maximum rated working pressure and manufactured with a 4:1 safety factor. Their compact design saves valuable space.

See last page for installation instructions.

Working pressure of standard hose and braid up to 1,325 psi (91 bar) or full vacuum and operating temperatures of -400°F (-240° C) to +1,500°F 816° C).

AnvilFlex connectors are manufactured with 321 stainless steel annular corrugated close pitch metal flexible hose. Other stainless steel and corrosion resistant alloys are available. Contact your ASC Engineered Solutions representative for additional information.

Parallel Offset Motion

Motion that occurs when one end of the hose assembly is deflected in a plane perpendicular to the longitudinal axis with the ends remaining parallel. Offset is measured as displacement of the free end centerline from the fixed end centerline.

Motion Frequency

Permanent Offset - The maximum fixed parallel offset to which the corrugated metal hose assembly may be bent without damage. No further motion is to be imposed other than normal vibration.

Intermittent Offset is motion that occurs on a regular or irregular cyclic basis. It is normally the result of thermal expansion and contraction or other non-continuous actions.

NOTE: AnvilFlex flex connectors are manufactured with a 4:1 safety factor.

AnvilFlex® Flex Connectors Fig. AF-21-RFF – Class 150 Flanged x Class 150 Flanged Reducing Flex Connector

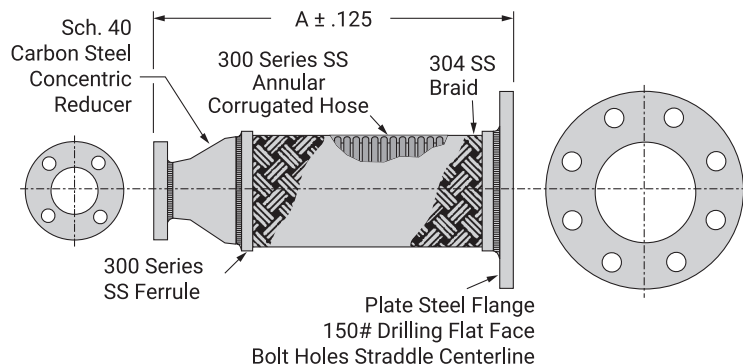

Nominal Size		Small O.D.	Large O.D.	Length	Pressure 70°F	Parallel Offset		Approx. Wt. Ea.
Small Flange	Large Flange					Permanent	Intermittent	
In./DN(mm)	In./DN(mm)	In./mm	In./mm	In./mm	PSI/bar	In./mm	In./mm	Lbs./kN
1½	2	1.66	2.375	14	450	1½	5/8	6.7
	50	42.2	60.3	355.6	31.0	38.1	15.9	3.0
40	2½	1.66	2.875	14	300	1¼	3/8	6.9
	65	42.2	73.0	355.6	20.7	31.8	9.5	3.1
	2½	2.375	2.875	14	300	1¼	3/8	8.1
	65	60.3	73.0	355.6	20.7	31.8	9.5	3.7
2	3	2.375	3.5	14	275	¾	3/8	10.1
	50	60.3	88.9	355.6	19	19.1	9.5	4.6
	4	2.375	4.5	15	270	½	¼	12
	100	60.3	114.3	381.0	18.6	12.7	6.4	5.4
	3	2.875	3.5	14	275	¾	3/8	11.2
	80	73.0	88.9	355.6	19.0	19.1	9.5	5.1
2½	4	2.875	4.5	15	270	½	¼	14.7
	65	73.0	114.3	381.0	18.6	12.7	6.4	6.7
	5	2.875	5.563	18	225	¾	3/8	18.9
	125	73.0	141.3	457.2	15.5	19.1	9.5	8.6
	6	2.875	6.625	19	165	¾	3/8	25.3
	150	73.0	168.3	482.6	11.4	19.1	9.5	11.5
3	4	3.5	4.5	15	270	½	¼	15.5
	100	88.9	114.3	381.0	18.6	12.7	6.4	7.0
80	5	3.5	5.563	18	225	¾	3/8	19.7
	125	88.9	141.3	457.2	15.5	19.1	9.5	8.9
	6	3.5	6.625	19	165	¾	3/8	26.1
	150	88.9	168.3	482.6	11.4	19.1	9.5	11.8
	5	4.5	5.563	18	225	¾	3/8	21.6
	125	114.3	141.3	457.2	15.5	19.1	9.5	9.8
4	6	4.5	6.625	19	165	¾	3/8	28
	100	114.3	168.3	482.6	11.4	19.1	9.5	12.7
	8	4.5	8.625	20	155	5/8	¼	38.4
	200	114.3	219.1	508.0	10.7	15.9	6.4	17.4
5	6	5.563	6.625	19	165	¾	3/8	31
	125	141.3	168.3	482.6	11.4	19.1	9.5	14.1
	8	5.563	8.625	20	155	5/8	¼	40.7
	200	141.3	219.1	508.0	10.7	15.9	6.4	18.5
6	8	6.625	8.625	20	155	½	¼	41.7
	150	168.3	219.1	508.0	10.7	12.7	6.4	18.9
	10	6.625	10.75	20	150	½	¼	83.1
	250	168.3	273.1	508.0	10.3	12.7	6.4	37.7
8	10	8.625	10.75	20	150	½	¼	95
	200	219.1	273.1	508.0	10.3	12.7	6.4	43.1
10	12	10.75	12.75	22	145	½	¼	125.9
	250	273.1	323.9	558.8	10.0	12.7	6.4	57.1

For Temp Above 70°F (21.6° C)

Temperature	Small O.D.
*F / °C	
70 21.1	1.00
200 93.3	0.94
300 148.8	0.88
400 204.4	0.83
500 260.0	0.78
600 315.6	0.74

For safe working pressure above 70°F (21.1° C), Multiply pressure shown at 70°F. times correction factor of require temperature.

*See Motion Classification on previous page for additional information.

Working pressures shown for the hose and braid are based on an operating temperature of 70° F (21° C) with a 4:1 safety factor.

AnvilFlex® Flex Connectors Fig. AF-21-RGF – Groove x Class 150 Flanged Reducing Flex Connector

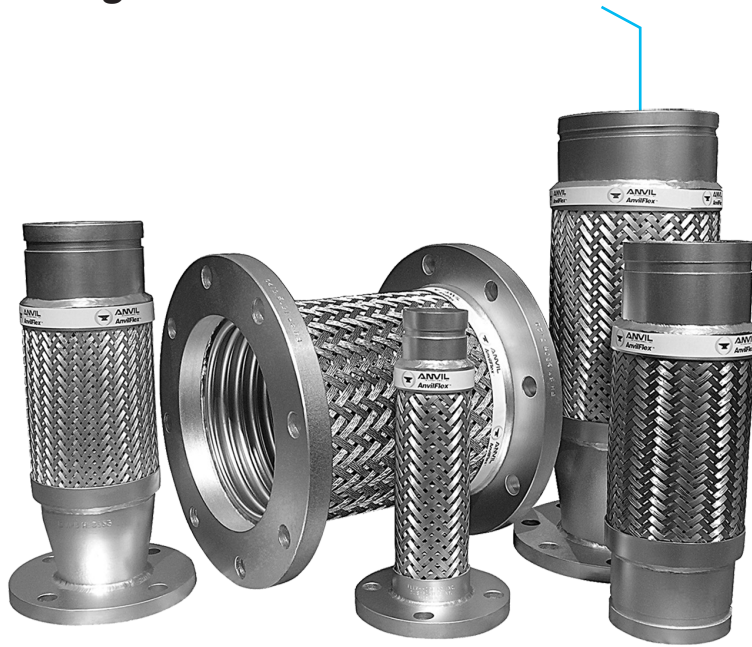

Material Specifications

Hose

300 Series Stainless Steel

Braid

Stainless Steel Type 304

Ends

Schedule 40 Carbon Steel Grooved-End x
Class 150 Reducing Flanged End

Motion Classifications

AnvilFlex flex connectors are braided pump connectors capable of handling the following movements:

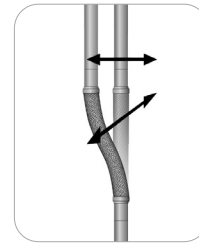

Parallel



Vibration

AnvilFlex Flexible connectors are used to prevent damage to pumps caused by piping stress. AnvilFlex connectors also absorb vibration and noise found in pump installations. AnvilFlex connectors are easily installed and reduce the possibility of pump failure.

They are designed to be pressure tested 1.5 times their maximum rated working pressure and manufactured with a 4:1 safety factor. Their compact design saves valuable space.

See last page for installation instructions.

Working pressure of standard hose and braid up to 1,325 psi (91 bar) or full vacuum and operating temperatures of -400°F (-240° C) to +1,500°F 816° C).

AnvilFlex connectors are manufactured with 321 stainless steel annular corrugated close pitch metal flexible hose. Other stainless steel and corrosion resistant alloys are available. Contact your ASC Engineered Solutions representative for additional information.

Parallel Offset Motion

Motion that occurs when one end of the hose assembly is deflected in a plane perpendicular to the longitudinal axis with the ends remaining parallel. Offset is measured as displacement of the free end centerline from the fixed end centerline.

Motion Frequency

Permanent Offset - The maximum fixed parallel offset to which the corrugated metal hose assembly may be bent without damage. No further motion is to be imposed other than normal vibration.

Intermittent Offset is motion that occurs on a regular or irregular cyclic basis. It is normally the result of thermal expansion and contraction or other non-continuous actions.

NOTE: AnvilFlex flex connectors are manufactured with a 4:1 safety factor.

AnvilFlex® Flex Connectors Fig. AF-21-RGF – Groove x Class 150 Flanged Reducing Flex Connector

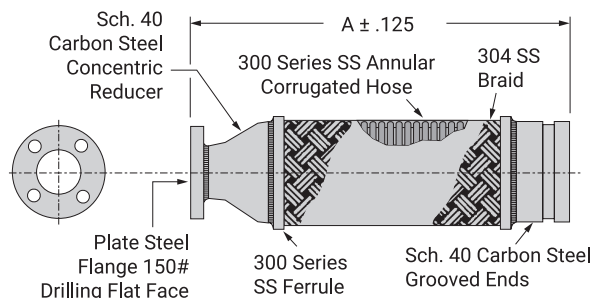

Nominal Size Small Flange	Large Groove & Hose	Small O.D.	Large O.D.	Length	Pressure 70°F	Parallel Offset		Approx. Wt. Ea.
						Permanent	Intermittent	
In./DN(mm)	In./DN(mm)	In./mm	In./mm	In./mm	PSI/bar	In./mm	In./mm	Lbs./kN
1½	2	1.660	2.375	14	450	1½	⅝	6.7
	50	42.2	60.3	355.6	31.0	38.1	15.9	3.0
40	2½	1.660	2.875	14	300	1¼	⅜	6.9
	65	42.2	73.0	355.6	20.7	31.8	9.5	3.1
2	2½	2.375	2.875	14	300	1¼	⅜	8.1
	65	60.3	73.0	355.6	20.7	31.8	9.5	3.7
50	3	2.375	3.500	14	275	¾	⅜	10.1
	80	60.3	88.9	355.6	19.0	19.1	9.5	4.6
2½	4	2.375	4.5	14	270	½	¼	12.0
	100	60.3	114.3	355.6	18.6	12.7	6.4	5.4
65	3	2.875	3.5	14	275	¾	⅜	11.2
	80	73.0	88.9	355.6	19.0	19.1	9.5	5.1
3	4	2.875	4.500	14	270	½	¼	14.7
	100	73.0	114.3	355.6	18.6	12.7	6.4	6.7
80	5	2.875	5.563	18	225	¾	⅜	18.9
	125	73.0	141.3	457.2	15.5	19.1	9.5	8.6
3	6	2.875	6.625	19	165	¾	⅜	25.3
	150	73	168.3	482.6	11.4	19.1	9.5	11.5
4	4	3.500	4.500	15	270	½	¼	15.5
	100	88.9	114.3	381.0	18.6	12.7	6.4	7.0
80	5	3.500	5.563	18	225	¾	⅜	19.7
	125	88.9	141.3	457.2	15.5	19.1	9.5	8.9
5	6	3.500	6.625	19	165	¾	⅜	26.1
	150	88.9	168.3	482.6	11.4	19.1	9.5	11.8
4	5	4.500	5.563	18	225	¾	⅜	21.6
	125	114.3	141.3	457.2	15.5	19.1	9.5	9.8
100	6	4.500	6.625	19	165	¾	⅜	28.0
	150	114.3	168.3	482.6	11.4	19.1	9.5	12.7
5	8	4.500	8.625	20	155	⅝	¼	38.4
	200	114.3	219.1	508.0	10.7	15.9	6.4	17.4
125	6	5.563	6.625	19	165	¾	⅜	31.0
	150	141.3	168.3	482.6	11.4	19.1	9.5	14.1
6	8	5.563	8.625	20	155	⅝	¼	40.7
	200	141.3	219.1	508.0	10.7	15.9	6.4	18.5
150	8	6.625	8.625	20	155	½	¼	41.7
	200	168.3	219.1	508.0	10.7	12.7	6.4	18.9
200	10	8.625	10.750	23	150	½	¼	84.0
	250	219.1	273.1	584.2	10.3	12.7	6.4	38.1
250	12	10.75	12.750	25	145	½	¼	102
	300	273.1	323.9	635.0	10.0	12.7	6.4	46.3

For Temp Above 70°F (21.6° C)

Temperature	Factor S.S.
*F / °C	
70	1.00
21.1	
200	0.94
93.3	
300	0.88
148.8	
400	0.83
204.4	
500	0.78
260.0	
600	0.74
315.6	

For safe working pressure above 70°F (21.1° C), Multiply pressure shown at 70°F. times correction factor of required temperature.

*See Motion Classification on previous page for additional information.

Working pressures shown for the hose and braid are based on an operating temperature of 70° F (21° C) with a 4:1 safety factor.

Coupling
Fig. 7004



The Gruvlok Fig. 7004 is designed to provide the versatility of a grooved joint while providing a rigid pipe joint.

The Fig. 7004 coupling permits working pressure ratings up to 1200 psi (82.7 bar).

This coupling is also suited for lower pressure systems which experience pressure pulses. Systems used for high pressure, including auto and truck washes, will benefit from the increased pressure capability.

Working Pressure & End Load values are based on grooved standard wall pipe.

Fig. 7004 provides a rigid joint and does not allow for expansion or contraction. The Fig. 7004 coupling is an ideal choice for higher pressure applications such as elevator services.

Note: Fig. 7004 can be used with EG fittings as a commercial joint only.

Material Specifications

Bolts

SAE J429, Grade 5, Zinc Electroplated
ISO 898-1, Class 8.8, Zinc Electroplated
followed by a Yellow Chromate Dip

Heavy Hex Nuts

ASTM A563, Grade A, Zinc Electroplated
ISO 898-2, Class 8.8, Zinc Electroplated
followed by a Yellow Chromate Dip

Stainless Steel Bolts & Nuts

304SS bolts and nuts are available
as a standard option.
(316SS are available for special order)

Housing

Ductile Iron conforming to ASTM A 536,
Grade 65-45-12.

Material Specifications (Continued)

Coatings

Rust inhibiting paint
Color: Orange (standard)
Hot Dipped Zinc Galvanized (optional)
Other Colors Available
(IE: RAL3000 and RAL9000)

For other Coating requirements contact an
ASC Engineered Solutions™ Representative.

Gasket Materials

Properties as designated in accordance with ASTM D2000

Grade "EP" EPDM (Green and Red color code) Standard
-40°F to 250°F (Service Temperature Range)
(-40°C to 121°C)

Recommended for water service, diluted acids, alkalies
solutions, oil-free air and many other chemical services.
NOT FOR USE IN PETROLEUM APPLICATIONS.

For hot water applications the use of Gruvlok Extreme
Temperature lubricant is recommended.

Grade "T" Nitrile (Orange color code)
-20°F to 180°F (Service Temperature Range)
(-29°C to 82°C)

Recommended for petroleum applications. Air with oil
vapors and vegetable and mineral oils.

NOT FOR USE IN HOT WATER OR HOT AIR.

Grade "O" Fluoro-Elastomer (Blue color code)

Size Range: 2" - 12" (C style only)
20°F to 300°F (Service Temperature Range)
(-29°C to 149°C)

Recommended for high temperature resistance
to oxidizing acids, petroleum oils, hydraulic fluids,
halogenated hydrocarbons and lubricants.

Grade "L" Silicone (Red color code)
Size Range: 2" - 12" (C style only)
-40°F to 350°F (Service Temperature Range)
(-40°C to 177°C)

Recommended for dry, hot air and some high
temperature chemical services.

Gasket Type

Standard C Style (2" - 12")
Flush Gap (2" - 12")

Lubrication

Standard Gruvlok
Gruvlok Xtreme (Do Not use with Grade "L")

Working Pressure, End Load, Pipe End Separation & Deflection from Center Line

Based on standard wall steel pipe with cut or roll
grooves in accordance with Gruvlok Specifications. See
technical data section for design factors.

Coupling Fig. 7004

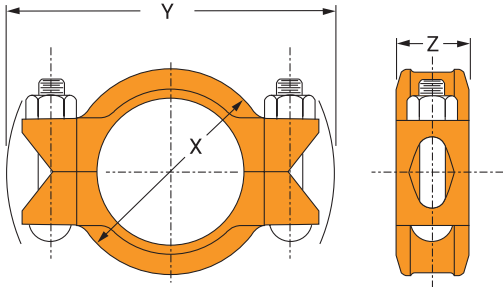

Fig. 7004 with Standard Gasket

Nominal Size	O.D.	Max. Wk. Pressure †	Max. End Load	Range of Pipe End Separation	Coupling Dimensions			Coupling Bolts		Approx. Wt. Ea.
					X	Y	Z	Qty.	Size	
In./DN(mm)	In./mm	PSI/bar	Lbs./kN	In./mm	In./mm	In./mm	In./mm	In./mm	Lbs./kg	
2	2.375	1200	5,316	0-1/32	3 5/8	6 1/4	1 7/8	2	5/8 x 2 3/4	3.9
50	60.3	82.7	23.6	0-0.79	92	159	48	2	-	1.8
2 1/2	2.875	1200	7,790	0-1/32	4 1/4	6 7/8	1 7/8	2	5/8 x 3 1/2	4.6
65	73.0	82.7	34.7	0-0.79	108	175	48	2	M16 x 85	2.1
3	3.500	1200	11,545	0-1/32	4 7/8	7 1/2	1 7/8	2	5/8 x 3 1/2	5.2
80	88.9	82.7	51.4	0-0.79	124	191	48	2	M16 x 85	2.4
4	4.500	1200	19,085	0-3/32	6 1/4	9 1/2	2 1/4	2	3/4 x 4 1/2	8.6
100	114.3	82.7	84.9	0-2.38	159	241	57	2	M20 x 110	3.9
5	5.563	1000	24,306	0-3/32	7 1/2	11	2 1/4	2	7/8 x 5 1/2	14.0
125	141.3	68.9	108.1	0-2.38	191	279	57	2	M22 x 150	6.4
6	6.625	1000	34,472	0-3/32	8 3/4	12 1/8	2 1/4	2	7/8 x 5 1/2	15.5
150	168.3	68.9	153.3	0-2.38	222	308	57	2	M22 x 150	7.0
8	8.625	800	46,741	0-3/32	11 1/8	14 7/8	2 5/8	2	1 x 5 1/2	25.6
200	219.1	55.2	207.9	0-2.38	283	378	67	2	-	11.6
10	10.750	800	72,610	0-3/32	13 1/2	17	2 5/8	2	1 x 6 1/2	32.3
250	273.1	55.2	323.0	0-2.38	343	432	67	2	-	14.7
12	12.750	800	102,141	0-3/32	15 7/8	19 1/4	2 5/8	2	1 x 6 1/2	43.9
300	323.9	55.2	454.4	0-2.38	403	489	67	2	-	19.9

Note:

† Maximum Working Pressure Rating is for schedule 40 steel pipe. For light wall, stainless steel, aluminum and ISO pipe pressure ratings, please refer to the technical data section.

For additional details see "Coupling Data Chart Notes" in the Introduction Section of the Gruvlok Catalog.

See Installation & Assembly directions in the Technical Data Section of the Gruvlok Catalog.

Not for use in copper systems.

High Pressure Coupling with End Guard Gasket Fig. 7004EG



The Gruvlok Fig. 7004EG High Pressure Coupling uses the specially designed "End Guard" gasket for use with "EG" grooved pipe. The "EG" gasket has a center rib which extends between the pipes in order to provide pipe end protection, which makes it ideally suited for internally lined or coated pipe applications.

The Fig. 7004EG High Pressure Coupling permits working pressure ratings up to 2500 psi (172.4 bar).

Working Pressure and End Load values are based on "EG" cut grooved schedule 80 steel pipe. Fig. 7004EG provides a rigid joint and does not allow for expansion or contraction. Beveled end pipe should not be used with "EG" gaskets.

Material Specifications

Bolts

SAE J429, Grade 5, Zinc Electroplated
ISO 898-1, Class 8.8, Zinc Electroplated
followed by a Yellow Chromate Dip

Heavy Hex Nuts

ASTM A563, Grade A, Zinc Electroplated
ISO 898-2, Class 8.8, Zinc Electroplated
followed by a Yellow Chromate Dip

Stainless Steel Bolts & Nuts

304SS bolts and nuts are available as a
standard option.
(316SS are available for special order).

Housing

Ductile Iron conforming to ASTM A536,
Grade 65-45-12.

Coatings

- Rust inhibiting paint
- Color: Black (standard)
- Hot Dipped Zinc Galvanized (optional)
- Other Colors Available
(IE: RAL3000 and RAL9000)

For other Coating requirements contact an
ASC Engineered Solutions™ Representative.

Gasket Materials

Properties as designated in accordance with
ASTM D2000

Grade "T" Nitrile (Orange color code) EG Gasket
-20°F to 180°F (Service Temperature Range)
(-29°C to 82°C)

Recommended for petroleum applications. Air
with oil vapors and vegetable and mineral oils.
NOT FOR USE IN HOT WATER OR HOT AIR.

Gasket Type

"EG" Style

Lubrication

- Standard Gruvlok
- Gruvlok Xtreme (Do Not use with Grade "L")

Working Pressure, End Load, Pipe End Separation & Deflection from Center Line

Based on schedule 80 steel pipe with cut
or roll grooves in accordance with Gruvlok
specifications. See Technical Data section
for design factors.

High Pressure Coupling with End Guard Gasket Fig. 7004EG

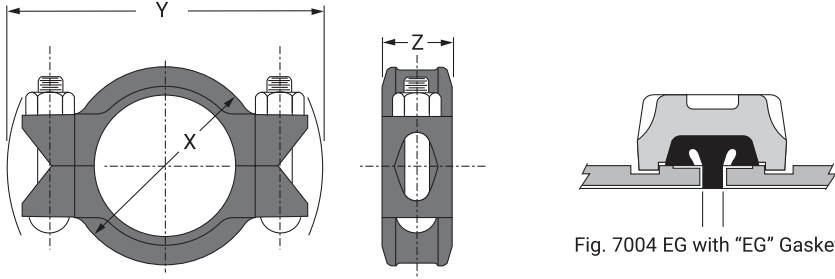

Fig. 7004 EG with "EG" Gasket

Nominal Size	O.D.	Max. Wk. Pressure	Max. End Load	Range of Pipe End Separation	Coupling Dimensions			Coupling Bolts		Approx. Wt. Ea.
					X	Y	Z	Qty.	Size	
In./DN(mm)	In./mm	PSI/bar	Lbs./kN	In./mm	In./mm	In./mm	In./mm	In./mm	Lbs./kg	
2 50	2.375 60.3	2500 172.4	11,075 49.27	0-1/32 0-0.79	3 5/8 92	6 1/4 159	1 7/8 48	2	5/8 x 2 3/4 -	4.1 1.9
2 1/2 65	2.875 73.0	2500 172.4	16,230 72.19	0-1/32 0-0.79	4 1/4 108	6 7/8 175	1 7/8 48	2	5/8 x 3 1/2 M16 x 85	5.1 2.3
3 80	3.500 88.9	2500 172.4	24,053 106.99	0-1/32 0-0.79	4 7/8 124	7 1/2 191	1 7/8 48	2	5/8 x 3 1/2 M16 x 85	5.5 2.5
4 100	4.500 114.3	2500 172.4	39,761 176.86	0-3/32 0-2.38	6 1/4 159	9 1/2 241	2 1/4 57	2	3/4 x 4 1/2 M20 x 110	9.0 4.1
6 150	6.625 168.3	2000 137.9	68,943 306.67	0-3/32 0-2.38	8 3/4 222	12 1/8 308	2 1/4 57	2	7/8 x 5 1/2 M22 x 150	15.5 7.0
8 200	8.625 219.1	1500 103.4	87,639 389.84	0-3/32 0-2.38	11 1/8 283	14 7/8 378	2 5/8 67	2	1 x 5 1/2 -	25.6 11.6
10 250	10.750 273.1	1250 86.2	113,453 504.66	0-3/32 0-2.38	13 1/2 343	17 432	2 5/8 67	2	1 x 6 1/2 -	32.3 14.7
12 300	12.750 323.9	1250 86.2	159,595 709.92	0-3/32 0-2.38	15 7/8 403	19 1/4 489	2 5/8 67	2	1 x 6 1/2 -	43.9 19.9

Notes:

For additional details, see "Coupling Data Chart Notes" in the Introduction Section of the Gruvlok Catalog.
Not for use in copper systems.

- Introduction
- Couplings
- Outlets
- Fittings
- Valves & Accessories
- High Pressure
- CTS Copper System
- Di-Electric Nipples
- Plan-End Fittings
- HDPE Couplings
- Socket-It® Fittings
- Stainless Steel Method
- Roll Groovers
- Installation & Assembly
- Special Coatings
- Design Services
- Technical Data
- Master Format 3 Part Specs.
- Pictorial Index

Rigid Coupling
Fig. 770

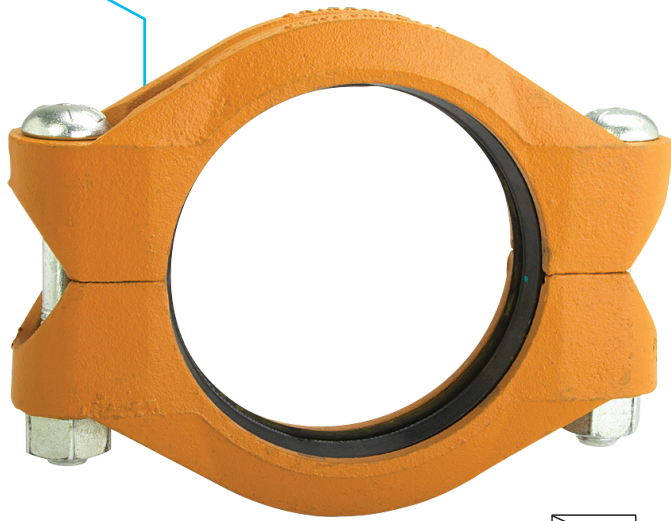

The Figure 770 Rigid Coupling provides a rigid joint by firmly gripping along the circumference of the pipe grooves. This coupling offers a dependable method for joining pipe and is an economical alternative to welding, threading, or using flanges. It is capable of pressures up to 1000 psi (68.9 bar) depending on pipe size and wall thickness.

Additional Features:

- Full 360° gripping of the groove circumference provides a strong rigid connection.
- Tongue-and-groove design simplifies installation

For Listings/Approval Details and Limitations, visit our website at www.asc-es.com or contact an ASC Engineered Solutions™ Sales Representative.

Material Specifications

Bolts

SAE J429, Grade 5, Zinc Electroplated (standard)

Heavy Hex Nuts

SAE A563, Grade A, Zinc Electroplated (standard)

Hardware Kits

304 Stainless Steel (available in sizes up to ¾")

Kit includes:

- (2) Bolts per ASTM A193, Grade B8
- (2) Heavy Hex Nuts per ASTM A194, Grade 8

Material Specifications (Continued)

Housing

Ductile Iron conforming to ASTM A536, Grade 65-45-12.

Rust inhibiting paint

Coatings

Color: Orange (standard)

Hot Dipped Zinc Galvanized (optional)

Other Colors Available

(IE: RAL3000 and RAL9000)

For other Coating requirements contact an ASC Representative

Gaskets

Properties as designated in accordance with ASTM D2000

Grade "EP" EPDM

(Green and Red color code)

Not available with 3"

-40°F to 250°F (Service Temperature Range)

(-40°C to 121°C)

Recommended for water service, diluted acids, alkalis solutions, oil-free air and many other chemical services.

NOT FOR USE IN PETROLEUM APPLICATIONS.

NSF-61 Certified

Grade "T" Nitrile (Orange color code)

NOT FOR USE IN DRINKING WATER

-20°F to 180°F (Service Temperature Range)

(-29°C to 82°C)

Recommended for petroleum applications, air with oil vapors and vegetable and mineral oils.

NOT FOR USE IN HOT WATER OR HOT AIR

Gasket Type

Standard C Style (2" - 8")

Lubrication

Standard

Gruvlok Xtreme

Rigid Coupling Fig. 770

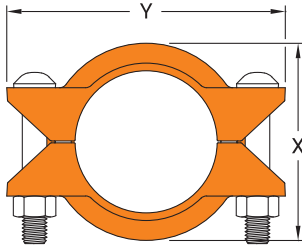

Nominal Size	O.D.	Max. Working Pressure †	Max. End Load †	Max. End Gap ‡	Coupling Dimensions			Coupling Bolts		Approx. Wt. Ea.
					X	Y	Z	Qty.	Size	
In./DN(mm)	In./mm	PSI/bar	Lbs./kN	In./mm	In./mm	In./mm	In./mm		In./mm	Lbs./kg
2	2.375	1000	4,430	0.14	3.53	5.72	1.88	2	5/8 x 2 3/4	3.4
50	60.3	68.9	19.71	3.6	89.7	145.3	47.8		M16 x 70	1.5
2 1/2	2.875	1000	6,492	0.14	4.06	6.00	1.88	2	5/8 x 3 1/2	4.0
65	73.0	68.9	28.88	3.6	103.1	152.4	47.8		M16 x 89	1.8
3	3.500	1000	9,621	0.14	4.78	6.76	1.88	2	5/8 x 3 1/2	5.3
80	88.9	68.9	42.79	3.6	121.4	171.7	47.8		M16 x 89	2.4
4	4.500	1000	15,904	0.25	6.01	8.50	2.10	2	3/4 x 4 1/4	7.3
100	114.3	68.9	70.74	6.4	152.7	215.9	53.3		M20 x 108	3.3
6	6.625	1000	34,472	0.25	8.51	11.25	2.10	2	7/8 x 5 1/2	15.0
150	168.3	68.9	153.33	6.4	216.2	285.8	53.3		M22 x 140	6.8
8	8.625	800	46,741	0.25	10.93	13.75	2.60	2	1 x 5 1/2	25.0
200	219.1	55.2	207.90	6.4	277.6	349.3	66.0		M24 x 140	11.3

Notes:

*Maximum available gap between pipe ends. Minimum gap = 0.

† Maximum Pressure and End Load are total from all loads based on standard weight steel pipe. Pressure ratings and end loads may differ for other pipe materials and/or wall thicknesses Contact an ASC Engineered Solutions™ Sales Representative for details.

‡ Max End Gap and Deflection is for cut grooved standard weight pipe. Values for roll grooved pipe will be half that of cut grooved.

- Introduction
- Couplings
- Outlets
- Fittings
- Valves & Accessories
- High Pressure
- CTS Copper System
- DI-Electric Nipples
- Plan-End Fittings
- HDPE Couplings
- Socket-It® Fittings
- Stainless Steel Method
- Roll Groovers
- Installation & Assembly
- Special Coatings
- Design Services
- Technical Data
- Master Format 3 Part Specs.
- Pictorial Index

Double Groove Coupling Fig. 7377

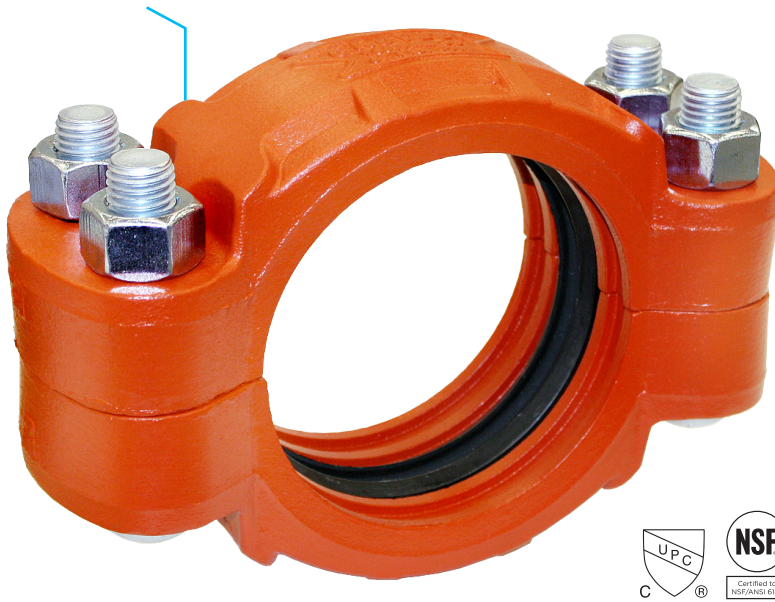

Gruvlok Fig. 7377 is a flexible coupling utilizing double groove technology designed for high pressure piping applications. Fig. 7377 is specifically designed for use in mining, oil, gas, slurry, sludge, and hydraulic systems. The maximum working pressure for each pipe schedule and size are listed in the table below. Fig. 7377 is an ideal solution for high pressure applications, exceeding ASC's Fig. 7004 capabilities. See page 265 for double groove piping dimensions.

Material Specifications

ANSI Bolts/Nuts

SAE J429, Grade 5, Zinc Electroplated

Heavy Hex Nuts

ASTM A563, Grade A, Zinc Electroplated

Housing

Ductile Iron conforming to ASTM A 536, Grade 65-45-12

Coatings

Rust inhibiting paint - Color: Copper (standard)
Hot Dipped Zinc Galvanized (optional)
Other Colors Available (IE: RAL3000 and RAL9000) For other Coating requirements contact an ASC Engineered Solution Representative

Gasket Materials

Properties as designated in accordance with ASTM D 2000

Grade "T" Nitrile (Orange color code) -20°F to 180°F (Service Temperature Range)(-29°C to 82°C)
Recommended for petroleum applications. Air with oil vapors and vegetable and mineral oils.
NOT FOR USE IN HOT WATER OR HOT AIR.

Additional gaskets available, please contact an ASC Engineered Solution Representative

Gasket Type

C Style (1" - 24")
Flush Gap (2" - 4")

Lubrication

Standard
Gruvlok Xtreme™ (Do Not use with Grade "L")

For Listings/Approval Details and Limitations, visit our website at www.asc-es.com or contact an ASC Engineered Solutions™ Sales Representative.

Double Groove Coupling Fig. 7377

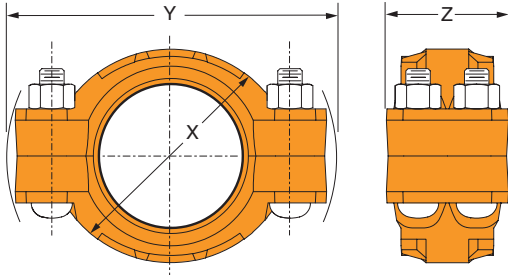

Nominal Size	O.D.	Schedule 160		Schedule 80		Range of Pipe End Separation		Coupling Dimensions			Coupling Bolts Qty.	Specified Torque §		Approx. Wt. Ea.	
		Max. Working Pressure	Max. End Load	Max. Working Pressure*	Max. End Load	Standard	End Guard	X	Y	Z		Size	Min.		Max.
In./DN(mm)	In./mm	PSI/bar	Lbs./kN	PSI/bar	Lbs./kN	In./mm	In./mm	In./mm	In./mm	In./mm		In./mm	Ft.-Lbs./N-m	Lbs./Kg	
6	6.625	4,000	137,886	3,000	103,415	0.070 - 0.250	0.110 - 0.290	8 ⁶ / ₇	12 ³ / ₄	5	4	1 x 5 ¹ / ₂	450	525	42.6
150	168.3	275.8	613.3	206.8	460.0	1.78 - 6.35	2.79 - 7.37	225	324	127		-	-	-	19.3
8	8.625	3,500	204,492	2,500	146,060	0.060 - 0.250	0.132 - 0.322	11 ¹ / ₈	15 ⁷ / ₈	6	4	1 ¹ / ₈ x 6 ¹ / ₂	500	600	72.0
200	219.1	241.3	909.6	172.4	649.6	1.52 - 6.35	3.35 - 8.18	287	396	152		-	-	-	32.7
10	10.750	3,000	272,288	2,500	226,906	0.080 - 0.250	0.152 - 0.322	13 ¹ / ₂	18 ³ / ₄	6 ¹ / ₈	4	1 ¹ / ₈ x 6 ¹ / ₂	500	600	98.3
250	273.1	206.8	1,211.1	172.4	1,009.3	2.03 - 6.35	3.86 - 8.18	343	476	156		-	-	-	44.6

*Maximum line pressure, including surge, to which a joint can be subjected. Working pressures are based on pipe in accordance with Gruvlok double cut groove specifications. Maximum allowable working pressure may be limited by code requirements, system components, and system design. Note: For a one time field test only, the maximum working pressure may be increased by 1.25 times the figure shown.

For additional details see "Coupling Data Chart Notes" in the Introduction Section of the Gruvlok Catalog.

§ - Lubricate bolts with Gruvlok Xtreme Lubricant.

See Installation & Assembly directions in the Technical Data Section of the Gruvlok Catalog.

- Introduction
- Couplings
- Outlets
- Fittings
- Valves & Accessories
- High Pressure
- CTS Copper System
- DI-Electric Nipples
- Plan-End Fittings
- HDPE Couplings
- Socket-It® Fittings
- Stainless Steel Method
- Roll Groovers
- Installation & Assembly
- Special Coatings
- Design Services
- Technical Data
- Master Format 3 Part Specs.
- Pictorial Index

Double Groove Coupling Fig. 7377

Gruvlok Standard Double Cut Groove Specification or Steel & Other IPS Or ISO Size Pipe

-1- Nominal IPS Pipe Size	-2- O.D.			-3- Gasket Seat "A" ±0.030/ ±0.76	-4- Groove Sep "G" ±0.005/ ±0.127	-5- Groove Width "B" ±0.030/ ±0.76	-6- Groove Diameter "C"		-7- Actual Groove Depth "D" (Ref. Only)	-8- Min. Allowable Bolt Torque Required for Assembly
	Actual	Tolerance					Actual	Tol. +0.000		
In./DN(mm)	In./mm	+In./mm	-In./mm	In./mm	In./mm	In./mm	In./mm	-In./mm	In./mm	Ft.-Lbs./N-m
6	6.625	+0.063	-0.031	0.625	0.785	0.375	6.340	-0.022	0.142	450
150	168.3	+1.60	-0.79	15.88	20.0	9.53	161.0	-0.56	3.6	610.2
8	8.625	+0.063	-0.031	0.750	0.855	0.500	8.240	-0.022	0.192	500
200	219.1	+1.60	-0.79	19.05	21.7	12.70	209.3	-0.56	4.9	678.0
10	10.750	+0.063	-0.031	0.750	0.855	0.500	10.350	-0.022	0.200	500
250	273.1	+1.60	-0.79	19.05	21.7	12.70	262.9	-0.56	5.1	678.0

Gruvlok "End Guard" Double Cut Groove Specification or Steel & Other Ips Or Iso Size Pipe

-1- Nominal IPS Pipe Size	-2- O.D.			-3- Gasket Seat "A" ±0.010/ ±0.76	-4- Groove Sep "G" ±0.005/ ±0.127	-5- Groove Width "B" +0.010/ -0.005	-6- Groove Diameter "C"		-7- Actual Groove Depth "D" (Ref. Only)	-8- Min. Allowable Bolt Torque Required for Assembly
	Actual	Tolerance					Actual	Tol. +0.000		
In./DN(mm)	In./mm	+In./mm	-In./mm	In./mm	In./mm	In./mm	In./mm	-In./mm	In./mm	Ft.-Lbs./N-m
6	6.625	+0.063	-0.031	0.605	0.785	0.375	6.340	-0.022	0.142	450
150	168.3	+1.60	-0.79	15.4	20.0	9.53	161.0	-0.56	3.6	610.2
8	8.625	+0.063	-0.031	0.714	0.855	0.500	8.240	-0.022	0.192	500
200	219.1	+1.60	-0.79	18.1	21.7	12.70	209.3	-0.56	4.9	678.0
10	10.750	+0.063	-0.031	0.714	0.855	0.500	10.350	-0.022	0.200	500
250	273.1	+1.60	-0.79	18.1	21.7	12.70	262.9	-0.56	5.1	678.0

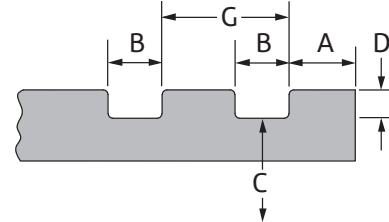

COLUMN 1
Nominal IPS Pipe size.
Nominal ISO Pipe size.

COLUMN 2
IPS outside diameter.
ISO outside diameter.

COLUMN 3, 4 & 5
Gasket seat must be free from scores, seams, chips, rust or scale which may interfere with proper coupling assembly.

COLUMN 6
The groove must be of uniform depth around the entire pipe circumference. (See column 7).

COLUMN 7
Groove depth: for reference only. Groove must conform to the groove diameter "C" listed in column 6.

COLUMN 8
Minimum allowable bolt torque required for complete assembly.

Out of roundness: Difference between maximum O.D. and minimum O.D. measured at 90° must not exceed total O.D. tolerance listed.

For IPS pipe, the maximum allowable tolerance from square cut ends is 0.03" for 1" thru 3½"; 0.045" for 4" thru 6"; and 0.060" for sizes 8" and above measured from a true square line.

For ISO size pipe, the maximum allowable tolerance from square cut ends is 0.75mm for sizes 25mm- 80mm; 1.15mm for sizes 100mm- 150mm; and 1.50mm for sizes 200mm and above, measured from a true square line.

Beveled-End Pipe in conformance with ANSI B16.25 (37½°) is acceptable, however square cut is preferred.

Fig. 7050 EG High Pressure 90° LR Elbow
Fig. 7051 EG High Pressure 45° LR Elbow

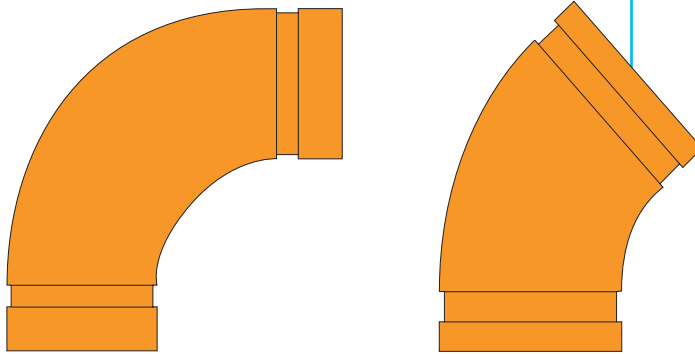

Fig. 7050 EG

Fig. 7051 EG

Gruvlok End Guard fittings are fabricated from extra heavy (XS) materials. The groove conforms to Gruvlok End Guard cut grooving specification. These fittings may be used for high pressure systems and where lined or coated fittings are required. Gruvlok EG fittings conform to NACE STD-RP-04-72 (Contact an ASC Engineered Solutions™ Representative with specific service details). End Guard fittings should only be used with Series 7004 Couplings and EG Gasket.

Double groove fittings available, please contact an ASC Engineered Solutions Sales Representative.

Material Specifications

Elbows

Extra strong forged steel fittings conforming to ASTM A234 with welded tangents of schedule 80 steel pipe conforming to ASTM A106.

Tees & Crosses

Segment welded schedule 80 steel pipe conforming to ASTM A106.

Coatings

- Rust inhibiting paint
- Color: Orange (standard)
- Hot Dipped Zinc Galvanized (optional)
- Other Colors Available (IE: RAL3000 and RAL9000)

For other Coating requirements contact an ASC Engineered Solutions Representative.

Fitting Size

Nominal Size	O.D.	Nominal Size	O.D.
In./DN(mm)	In./mm	In./DN(mm)	In./mm
1	1.315	3	3.500
25	33.7	80	88.9
1¼	1.660	4	4.500
32	42.4	100	114.3
1½	1.900	5	5.563
40	48.3	140	141.3
2	2.375	6	6.625
50	60.3	150	168.3
2½	2.875	8	8.625
65	73.0	200	219.1

Fig. 7050 EG
High Pressure 90° LR Elbow

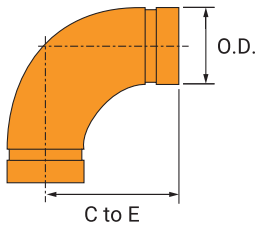

Nominal Size	O.D.	Center to End	Approx. Wt. Ea.
In./DN(mm)	In./mm	In./mm	Lbs./kg
2	2.375	3¼	2.5
50	60.3	83	1.1
2½	2.875	3¾	4.2
65	73.0	95	1.9
3	3.500	4¼	6.0
80	88.9	108	2.7
4	4.500	5	11.0
100	114.3	127	5.0
6	6.625	6½	27.2
150	168.3	165	12.4
8	8.625	*	*
200	219.1	*	*
10	10.750	*	*
250	273.0	*	*
12	12.750	*	*
300	323.9	*	*

Note:

*Contact an ASC Engineered Solutions™ Representative for more information.

Fig. 7051 EG
High Pressure 45° LR Elbow

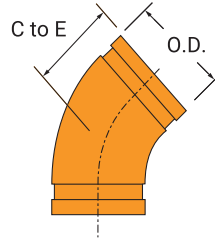

Nominal Size	O.D.	Center to End	Approx. Wt. Ea.
In./DN(mm)	In./mm	In./mm	Lbs./kg
2	2.375	2	1.8
50	60.3	51	0.8
2½	2.875	2¼	2.9
65	73.0	57	1.3
3	3.500	2½	4.3
80	88.9	64	2.0
4	4.500	3	7.5
100	114.3	76	3.4
6	6.625	3½	16.5
150	168.3	89	7.5
8	8.625	*	*
200	219.1	*	*
10	10.750	*	*
250	273.0	*	*
12	12.750	*	*
300	323.9	*	*

Note:

*Contact an ASC Engineered Solutions™ Representative for more information.

Fig. 7060 EG High Pressure Tee
Fig. 7662 EG High Pressure Header Tee
Fig. 7068 EG High Pressure Cross

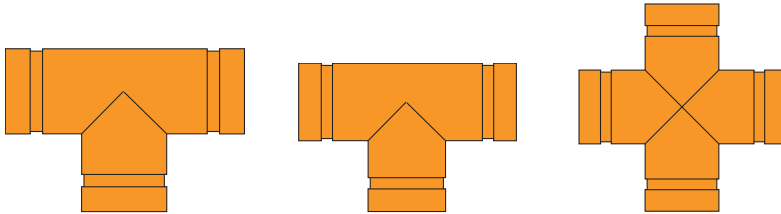

Fig. 7060 EG

Fig. 7662 EG

Fig. 7068 EG

Gruvlok End Guard fittings are fabricated from extra heavy (XS) materials. The groove conforms to Gruvlok End Guard cut grooving specification. These fittings may be used for high pressure systems and where lined or coated fittings are required. Gruvlok EG fittings conform to NACE STD-RP-04-72 (Contact an ASC Engineered Solutions™ Representative with specific service details). End Guard fittings should only be used with Series 7004 Couplings and EG Gasket.

Double groove fittings available, please contact an ASC Engineered Solutions Sales Representative.

Material Specifications

Elbows

Extra strong forged steel fittings conforming to ASTM A 234 with welded tangents of schedule 80 steel pipe conforming to ASTM A 106.

Tees & Crosses

Forged Steel conforming to ASTM A 106.

Coatings

Rust inhibiting paint – Color: Orange (standard)

Hot Dipped Zinc Galvanized (optional)

Other Colors Available (IE: RAL3000 and RAL9000)

For other Coating requirements contact an ASC Engineered Solutions Representative.

Fitting Size

Nominal Size	O.D.
In./DN(mm)	In./mm
1	1.315
25	33.7
1 ¼	1.660
32	42.4
1 ½	1.900
40	48.3
2	2.375
50	60.3
2 ½	2.875
65	73.0
3	3.500
80	88.9
4	4.500
100	114.3
5	5.563
140	141.3
6	6.625
150	168.3
8	8.625
200	219.1

Fig. 7060 EG
High Pressure Tee

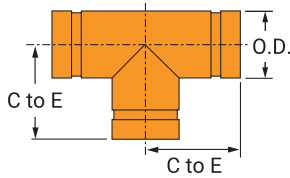

Nominal Size	O.D.	Center to End	Approx. Wt. Ea.
In./DN(mm)	In./mm	In./mm	Lbs./kg
2	2.375	3¼	3.3
50	60.3	83	1.5
2½	2.875	3¾	5.1
65	73.0	95	2.3
3	3.500	4¼	9.3
80	88.9	108	4.2
4	4.500	5	15.9
100	114.3	127	7.2
6	6.625	6½	38.5
150	168.3	165	17.5
8	8.625	*	*
200	219.1	*	*
10	10.750	*	*
250	273.0	*	*
12	12.750	*	*
300	323.9	*	*

Note:

*Contact an ASC Engineered Solutions Rep. for more information.

Fig. 7662 EG
High Pressure Header Tee

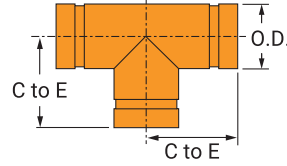

Nominal Size	O.D.	Center to End	Approx. Wt. Ea.
In./DN(mm)	In./mm	In./mm	Lbs./kg
2	2.375	6½	4.9
50	60.3	165	2.2
2	2.375	5	3.6
50	60.3	127	1.6

Fig. 7068 EG
High Pressure Cross

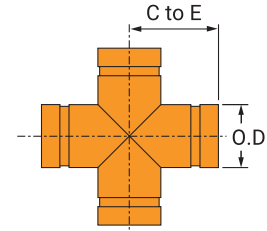

Nominal Size	O.D.	Center to End	Approx. Wt. Ea.
In./DN(mm)	In./mm	In./mm	Lbs./kg
2	2.375	3¼	3.9
50	60.3	83	1.8
2½	2.875	3¾	6.8
65	73.0	95	3.1
3	3.500	4¼	11.5
80	88.9	108	5.2
4	4.500	5	19.3
100	114.3	127	8.8
6	6.625	6½	46.0
150	168.3	165	20.9
8	8.625	*	*
200	219.1	*	*
10	10.750	*	*
250	273.0	*	*
12	12.750	*	*
300	323.9	*	*

Note:

*Contact an ASC Engineered Solutions Rep. for more information.

Technical Data CTS Copper System



The Gruvlok® CTS Copper System offers an installer of large diameter copper tubing an alternative to the conventional soldering and brazing. This new grooved copper system is faster and easier to install. Temperature and weather conditions are no longer a factor when planning installations. There is no sweating or brazing as this system requires only a wrench for assembly on grooved end pipe.

The copper system is "flame free". Essentially you save time and enjoy a very reliable system that is both versatile and economical. Safety is a factor as there is no fire hazard, especially in a retrofit installation. The ease of assembly is a great benefit in new construction and ease of disassembly is ideal for renovation, retrofit or expansion.

Benefits

- Fast and easy to assemble.
- No flame, no sweat
- Each joint has a union.
- Provides rigidity
- Easily roll grooved
- Proven joint reliability
- Accepted and approved.
- Economical and reliable

- Introduction
- Couplings
- Outlets
- Fittings
- Valves & Accessories
- High Pressure
- CTS Copper System**
- D-Electric Nipples
- Plan-End Fittings
- HDPE Couplings
- Sock-It® Fittings
- Stainless Steel Method
- Roll Groovers
- Installation & Assembly
- Special Coatings
- Design Services
- Technical Data
- Master Format 3 Part Specs.
- Pictorial Index

CTS SlideLOK® Ready for Installation Coupling Fig. 64

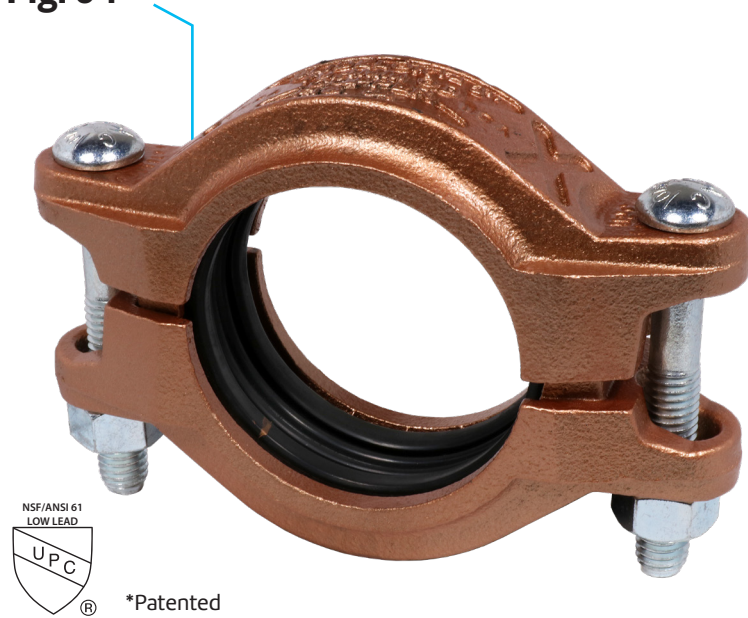

The CTS SlideLOK coupling is a ready for installation coupling designed to reduce installation time. The slide action allows for a smooth trouble free installation. The patented gasket provides four separate sealing surfaces for added protection. The engineered predictive gap is a quick and easy indication of proper assembly.

The CTS SlideLOK is designed to be used with copper tube sizes 2" - 8" and produces a secure, rigid joint connection.

The CTS SlideLOK coupling allows for a maximum working pressure of 300 psi for Type K or L. Contact an ASC Engineered Solutions™ Representative for other copper tube pressure ratings.

*Patent: D680629, D680630, D696751

For Listings/Approval Details and Limitations, visit our website at www.asc-es.com or contact an ASC Engineered Solutions Sales Representative

Material Specifications

Bolts

SAE J429, Grade 5, Zinc Electroplated

Heavy Hex Nuts

ASTM A563, Grade A, Zinc Electroplated

Housing

Ductile Iron conforming to ASTM A536, Grade 65-45-12

Coatings

Rust inhibiting paint
Color: Copper (standard)

Gaskets

Properties as designated in accordance with ASTM D2000

Grade "EP" EPDM (Copper color code)

-40°F to 250°F (Service Temperature Range)
(-40°C to 121°C)

Recommended for water service, diluted acids, alkalis solutions, oil-free air and many other chemical services.

NOT FOR USE IN PETROLEUM APPLICATIONS.

Gasket Type

SlideLOK (2" - 8")

Lubrication

Standard
Gruvlok Xtreme



SlideLOK Pressure Responsive Gasket

CTS SlideLOK® Ready for Installation Coupling Fig. 64

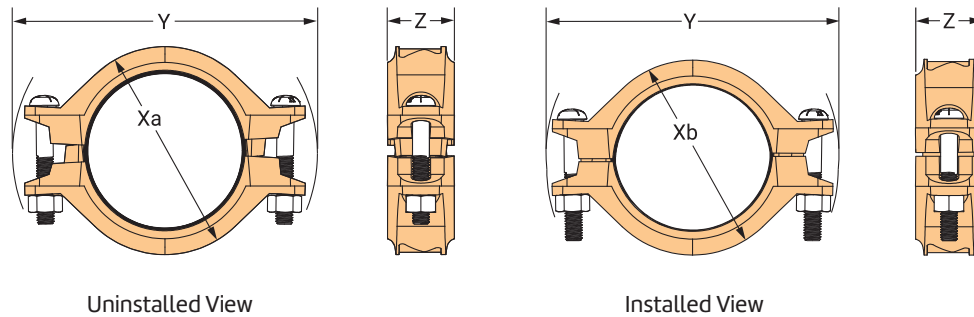

Nominal Size	O.D.	Max. Working Pressure	Max. End Load	Range of Pipe End Separation	Coupling Dimensions				Coupling Bolts		Approx. Wt. Ea.
					Xa	Xb	Y	Z	Qty.	Size	
In./DN(mm)	In./mm	PSI/bar	Lbs./kN	In./mm	In./mm	In./mm	In./mm	In./mm	In./mm	Lbs./kg	
2 50	2.125 54.0	300 20.7	1,064 4.73	0-0.08 0-2.0	3½ 89	3¼ 83	5½ 140	1⅝ 49	2	½ x 2¾ M12 x 70	2.4 1.1
2½ 65	2.625 66.7	300 20.7	1,624 7.22	0-0.08 0-2.0	4 102	3¾ 95	6 152	1⅝ 49	2	½ x 2¾ M12 x 70	2.6 1.2
3 80	3.125 79.4	300 20.7	2,301 10.24	0-0.08 0-2.0	4⅝ 117	4¼ 108	6¾ 171	1⅝ 49	2	½ x 3½ M12 x 89	3.5 1.6
4 100	4.125 104.8	300 20.7	4,009 17.83	0-0.13 0-3.3	5½ 140	5⅝ 130	8 203	2 51	2	½ x 3½ M12 x 89	4.0 1.8
5 125	5.125 130.2	300 20.7	6,189 27.53	0-0.13 0-3.3	6⅝ 168	6¼ 159	9¼ 235	2 51	2	⅝ x 3½ M16 x 89	5.0 2.3
6 150	6.125 155.6	300 20.7	8,839 39.32	0-0.13 0-3.3	7¾ 197	7¼ 184	10¼ 260	2 51	2	⅝ x 3½ M16 x 89	5.8 2.6
8 200	8.125 206.4	300 20.7	15,555 69.19	0.07-0.13 0-3.3	9¾ 248	9¼ 235	12¼ 311	2 51	2	⅝ x 4¼ M16 x 110	8.0 3.6

Notes:

For additional details see "Coupling Data Chart Notes" in the Introduction Section of the Gruvlok Catalog.

See Installation & Assembly directions in the Technical Data Section of the Gruvlok Catalog.

Transition Coupling for Joining Stainless Steel IPS to Copper Tubing Systems Fig. 617

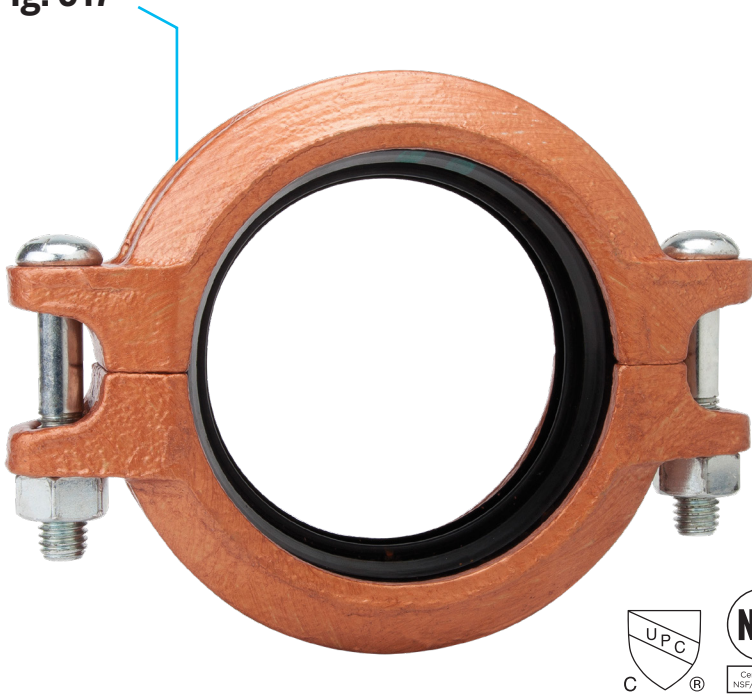

The Gruvlok Figure 617 Transition Coupling provides a direct connection between like-sized grooved-end IPS Stainless Steel pipe and fittings and grooved-end CTS Copper Tubing and fittings. The coupling is comprised of two ductile iron housings, a specially designed pressure-responsive rubber transition gasket, and track bolts and nuts.

Material Specifications

ANSI Bolts/Nuts

SAE J429, Grade 5,
Zinc Electroplated (standard)

Heavy Hex Nuts

SAE A563, Grade A,
Zinc Electroplated (standard)

Hardware Kits

304 Stainless Steel
(available in sizes up to ¾")

Kit includes:

- (2) Bolts per ASTM A193, Grade B8 and
- (2) Heavy Hex Nuts per ASTM A194, Grade 8.

EcoGuard (available in sizes up to ¾")

Kit includes:

- (2) Bolts per SAE J429, Grade 5, with EcoGuard corrosion-resistant zinc flake coating and (2) Heavy Hex Nuts per ASTM A563, Grade A, EcoGuard corrosion-resistant zinc flake coating.

Housing

Ductile Iron conforming to ASTM A 536,
Grade 65-45-12.

Coatings

- Rust inhibiting paint -
Color: Copper (standard)
- Hot Dipped Zinc Galvanized (optional)

Gasket Materials

Properties as designated in accordance
with ASTM D 2000

- Grade "EP" EPDM (Copper)
-40°F to 250°F (Service Temperature
Range) (-40°C to 121°C) Recommended
for water service, diluted acids, alkalis
solutions, oil-free air and many other
chemical services.
NOT FOR USE IN PETROLEUM
APPLICATIONS.

Material Specifications (Continued)

Gasket Materials (Continued)

For hot water applications the use of Gruvlok Xtreme™ Temperature lubricant is recommended. NSF-61.

Grade "T" Nitrile (Orange color code)

NOT FOR USE IN DRINKING WATER
-20°F to 180°F (Service Temperature Range)
(-29°C to 82°C) Recommended for petroleum
applications. air with oil vapors and vegetable
and mineral oils.

NOT FOR USE IN HOT WATER OR HOT AIR

Grade "O" Fluoro-Elastomer (Blue color code)

NOT FOR USE IN DRINKING WATER
Size Range: 1" - 12" (C style only)
20°F to 300°F (Service Temperature Range)
(-29°C to 149°C)

Recommended for high temperature
resistance to oxidizing acids, petroleum oils,
hydraulic fluids, halogenated hydrocarbons
and lubricants.

Grade "L" Silicone (Red color code)

NOT FOR USE IN DRINKING WATER
Size Range: 1" - 12" (C style only)
-40°F to 350°F (Service Temperature Range)
(-40°C to 177°C)

Recommended for dry, hot air and some high
temperature chemical services. Contact an
ASC Engineered Solutions™ Representative
for availability.

Gasket Type

- C Style (1" - 24")
- Flush Gap (2" - 4")

Lubrication

- Standard
- Gruvlok Xtreme (Do not use with Grade "L")

For Listings/Approval Details and Limitations, visit our
website at www.asc-es.com or contact an ASC
Engineered Solutions™ Sales Representative.

Transition Coupling for Joining Stainless Steel IPS to Copper Tubing Systems Fig. 617

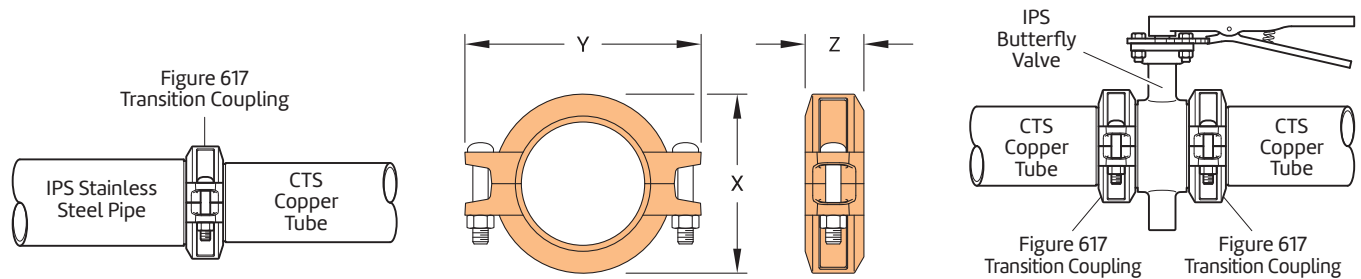

Nominal Size	O.D. IPS x CTS	Max. Working Pressure (CWP)	Axial Displacement	Deflection from ϕ Per Coupling	Coupling Dimensions			Coupling Bolt Size	Approx. Wt. Ea.
					X	Y	Z		
In./DN(mm)	In./mm	PSI/bar	In./mm	Deg.(°)-Min (')	In./mm	In./mm	In./mm	In./mm	Lbs./kg
2 50	2.375 x 2.125 60.3 x 54.0	300 20.0	0-0.06 0-1.6	1° 31'	3.31 84	5.08 129	1.89 48	1/2 x 2 1/8	2.0 0.9
2 1/2 65	2.875 x 2.625 73.0 x 66.7	300 20.0	0-0.06 0-1.6	1° 15'	3.9 99	5.59 142	1.89 48	3/8 x 2 1/8	2.2 1.0
3 80	3.500 x 3.125 88.9 x 79.4	300 20.0	0-0.06 0-1.6	1° 02'	4.57 116	6.65 169	1.89 48	1/2 x 3	3.0 1.4
4 100	4.500 x 4.125 114.3 x 104.8	300 20.0	0-0.06 0-1.6	1° 36'	7.76 197	7.76 197	2.05 52	1/2 x 3	4.2 1.9

- Introduction
- Couplings
- Outlets
- Fittings
- Valves & Accessories
- High Pressure
- CTS Copper System
- DI-Electric Nipples
- Plan-End Fittings
- HDPE Couplings
- Socket-Fittings
- Stainless Steel Method
- Roll Groovers
- Installation & Assembly
- Special Coatings
- Design Services
- Technical Data
- Master Format 3 Part Specs.
- Pictorial Index

Flange Adapter Fig. 6084

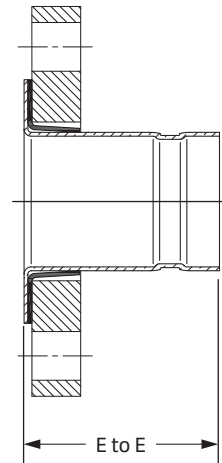
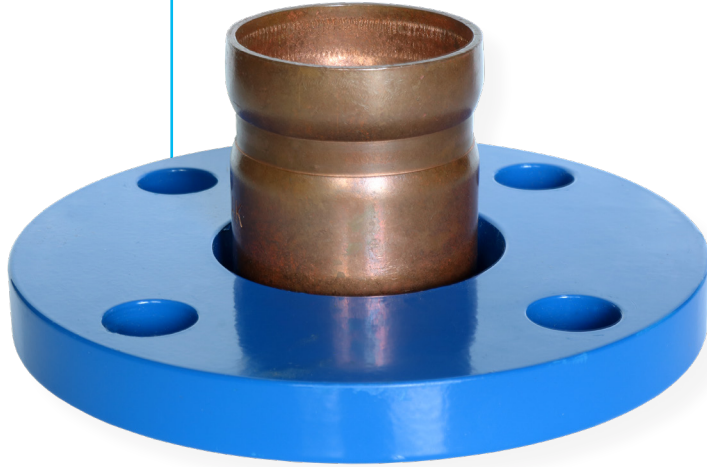

The Gruvlok Fig. 6084 Flange Adapter allows for direct connection of Class 125 or Class 150 flanged components to the CTS Copper System. The CTS Copper Flange Adapter (Sizes 2" thru 6") conforms to ANSI class 125/150 bolt patterns and is rated at 300 PSIG (20.7 bar). The flange adapter is a dielectric union, utilizing the epoxy coating as a suitable replacement for flange dielectric insulation kits.

Nominal Size	Copper Tube Diameter	E to E		Approx. Wt. Ea.
		In.	In./mm	
2	2.125	2.63	66.8	0.85
	54.0			0.39
2½	2.625	2.00	50.8	1.34
	66.7			0.61
3	3.125	2.44	62.0	1.73
	79.4			0.78
4	4.125	2.88	73.2	2.43
	104.8			1.10
5	5.125	3.94	100.1	3.27
	130.2			1.48
6	6.125	4.31	109.5	4.78
	155.6			2.17

CTS Fittings Fig. 601, 610, 618, 619, 621, 650, 652, 660



Gruvlok Full-Flow Grooved Fittings for Copper Piping Systems provide an economical and efficient method of changing direction. These copper fittings are available in sizes 2" to 8" (50 - 200mm).

Cast fittings in 90° and 45° elbows, tees, caps, concentric reducers, and reducing tees are cast with a copper alloy conforming to CDA C89833. Cast fittings are stronger and more durable than wrought copper fittings and are less susceptible to damage in transit or during installation. Reducing fittings are available with Groove x Groove or Groove x Cup End configurations.

Fittings are standard radius, full flow, designed for installation with Gruvlok Copper System products.

For additional listings or approvals, visit our website at www.asc-es.com.

Material Specifications

Cast Copper Alloy Fittings

Copper Alloy conforming to CDA C89833 or C83470

Wrought Copper Fittings

(For Figure 652 Groove by Copper Fittings Only)
ASTM B 75 C12200; wall thickness per ASTM B 88 Type L.

Maximum Working Pressure

Fittings are rated at the pressure rating of the Gruvlok Coupling or Adapter in use.

- Introduction
- Couplings
- Outlets
- Fittings
- Valves & Accessories
- High Pressure
- CTS Copper System
- D-I-Electric Nipples
- Plain-End Fittings
- HDPE Couplings
- Sock-It® Fittings
- Stainless Steel Method
- Roll Groovers
- Installation & Assembly
- Special Coatings
- Design Services
- Technical Data
- Master Format 3 Part Specs.
- Pictorial Index

Fig. 610
90° CTS Elbow

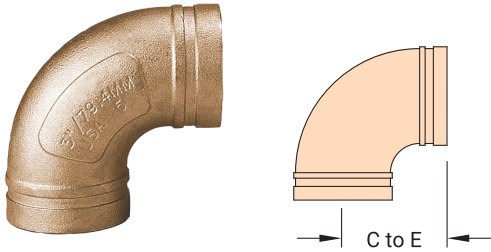

Nominal Size	Copper Tubing O.D.	Center to End	Approx. Wt. Ea.
In./DN(mm)	In./mm	In./mm	Lbs./kg
2	2.125	2.91	1.9
50	54.0	73.9	0.9
2½	2.625	3.31	2.7
65	66.7	84.1	1.2
3	3.125	3.81	3.6
80	79.4	96.8	1.6
4	4.125	4.75	7.1
100	104.8	120.7	3.2
5	5.125	5.94	11.9
125	130.2	150.9	5.4
6	6.125	6.94	16.7
150	155.6	176.7	7.6
8	8.125	7.75	25.3
200	206.4	196.9	11.5

Fig. 601
45° CTS Elbow

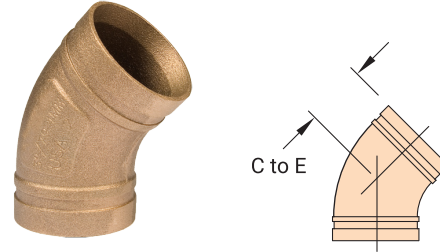

Nominal Size	Copper Tubing O.D.	Center to End	Approx. Wt. Ea.
In./DN(mm)	In./mm	In./mm	Lbs./kg
2	2.125	2.19	1.6
50	54.0	55.6	0.7
2½	2.625	2.31	2.1
65	66.7	58.7	1.0
3	3.125	2.59	2.7
80	79.4	65.8	1.2
4	4.125	3.19	5.5
100	104.8	81.0	2.5
5	5.125	3.25	7.7
125	130.2	82.6	3.5
6	6.125	3.50	10.1
150	155.6	88.9	4.6
8	8.125	4.25	16.6
200	206.4	108.0	7.5

Note:

For information on larger sizes, contact an ASC Engineered Solutions™ Sales Representative.
See page 281 for CTS Fitting Specifications.

Fig. 619
CTS Tee

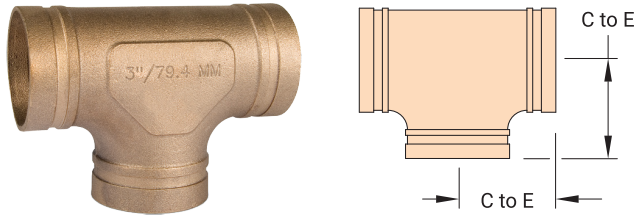

Nominal Size	Copper Tubing O.D.	Center to End	Approx. Wt. Ea.
In./DN(mm)	In./mm	In./mm	Lbs./kg
2	2.125	2.69	2.5
50	54.0	68.3	1.1
2½	2.625	3.20	3.8
65	66.7	81.3	1.7
3	3.125	3.52	4.7
80	79.4	89.4	2.1
4	4.125	4.25	9.0
100	104.8	108.0	4.1
5	5.125	5.94	17.7
125	130.2	150.9	8.0
6	6.125	6.94	24.8
150	155.6	176.3	11.3
8	8.125	7.75	46.2
200	206.4	196.9	21.0

Note:

For information on larger sizes, contact an ASC Engineered Solutions Sales Representative.

See page 309 for CTS Fitting Specifications.

Fig. 660
CTS Cap

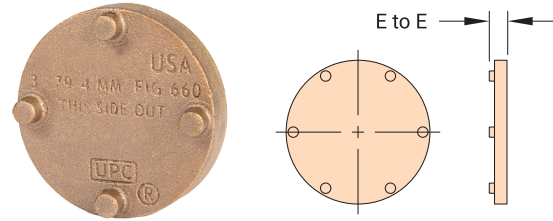

Nominal Size	Copper Tubing O.D.	Center to End	Approx. Wt. Ea.
In./DN(mm)	In./mm	In./mm	Lbs./kg
2	2.125	0.92	0.6
50	54.0	23.4	0.3
2½	2.625	0.92	1.0
65	66.7	23.4	0.4
3	3.125	0.92	1.3
80	79.4	23.4	0.6
4	4.125	0.92	2.2
100	104.8	23.4	1.0
5	5.125	0.92	5.8
125	130.2	23.4	2.6
6	6.125	0.92	8.1
150	155.6	23.4	3.7
8	8.125	1.03	14.1
200	206.4	26.2	6.4

- Introduction
- Couplings
- Outlets
- Fittings
- Valves & Accessories
- High Pressure
- CTS Copper System
- Di-Electric Nipples
- Plan-End Fittings
- HDPE Couplings
- Socket-Fittings
- Stainless Steel Method
- Roll Groovers
- Installation & Assembly
- Special Coatings
- Design Services
- Technical Data
- Master Format 3 Part Specs.
- Pictorial Index

Fig. 621
CTS Reducing Tee

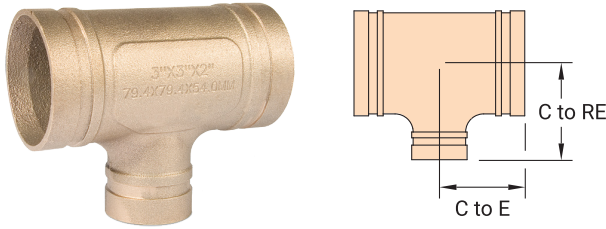
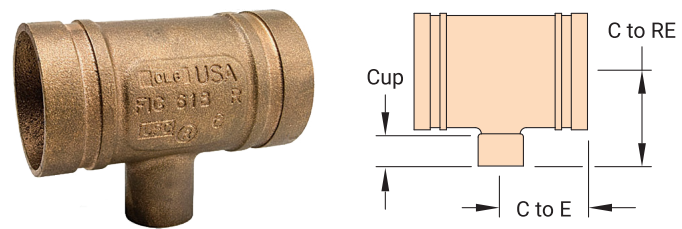

Fig. 618
CTS Reducing Tee (Groove x Groove x Cup)



Nominal Size	Copper Tubing O.D.	C to E	C to RE	Approx. Wt. Ea.
In./DN(mm)	In./mm	In./mm	In./mm	Lbs./kg
2½ x 2½ x 2 65 x 65 x 50	2.625 x 2.625 x 2.125 66.7 x 66.7 x 54.0	3.28 83.3	3.38 85.9	3.5 1.6
3 x 3 x 2 80 x 80 x 50	3.125 x 3.125 x 2.125 79.4 x 79.4 x 54.0	3.00 76.2	3.38 85.9	3.7 1.7
3 x 3 x 2½ 80 x 80 x 65	3.125 x 3.125 x 2.625 79.4 x 79.4 x 66.7	3.35 82.6	3.50 88.9	4.1 1.9
4 x 4 x 2 100 x 100 x 50	4.125 x 4.125 x 2.125 104.8 x 104.8 x 54.0	3.66 93.0	4.13 104.9	6.8 3.1
4 x 4 x 2½ 100 x 100 x 65	4.125 x 4.125 x 2.625 104.8 x 104.8 x 66.7	3.94 100.1	4.06 103.1	7.3 3.3
4 x 4 x 3 100 x 100 x 80	4.125 x 4.125 x 3.125 104.8 x 104.8 x 79.4	4.19 106.4	4.16 105.7	7.8 3.6
5 x 5 x 3 125 x 125 x 80	5.125 x 5.125 x 3.125 130.2 x 130.2 x 79.4	3.75 95.3	4.63 117.6	9.4 4.2
5 x 5 x 4 125 x 125 x 100	5.125 x 5.125 x 4.125 130.2 x 130.2 x 104.8	4.25 108.0	4.56 115.8	11.0 5.0
6 x 6 x 2½ 150 x 150 x 65	6.125 x 6.125 x 2.625 155.6 x 155.6 x 66.7	3.63 92.2	5.13 130.3	10.8 4.9
6 x 6 x 3 150 x 150 x 80	6.125 x 6.125 x 3.125 155.6 x 155.6 x 79.4	3.69 93.7	5.19 131.8	11.1 5.0
6 x 6 x 4 150 x 150 x 100	6.125 x 6.125 x 4.125 155.6 x 155.6 x 104.8	4.19 106.4	5.13 130.3	12.9 5.8
6 x 6 x 5 150 x 150 x 125	6.125 x 6.125 x 5.125 155.6 x 155.6 x 130.2	4.69 119.1	5.19 131.8	14.8 6.7

Note:

Dimensional information in this chart is for cast fittings

Nominal Size	Copper Tubing O.D.	C to E	C to RE	Cup	Approx. Wt. Ea.
In./DN(mm)	In./mm	In./mm	In./mm	In./mm	Lbs./kg
2 x 2 x ¾ 50 x 50 x 20	2.125 x 2.125 x 0.825 54.0 x 54.0 x 21.0	2.20 55.9	2.04 51.8	0.75 19.0	1.6 0.7
2 x 2 x 1 50 x 50 x 25	2.125 x 2.125 x 1.125 54.0 x 54.0 x 25.4	2.33 59.1	2.26 57.4	0.91 23.1	1.8 0.8
2 x 2 x 1¼ 50 x 50 x 32	2.125 x 2.125 x 1.375 54.0 x 54.0 x 34.9	2.48 63.0	2.41 61.2	0.97 24.6	2.0 0.9
2 x 2 x 1½ 50 x 50 x 40	2.125 x 2.125 x 1.625 54.0 x 54.0 x 38.1	2.55 64.7	2.34 59.4	1.09 27.7	2.0 0.9
2½ x 2½ x ¾ 65 x 65 x 20	2.625 x 2.625 x 0.875 66.7 x 66.7 x 21.0	2.27 57.7	2.24 57.0	0.75 19.0	2.2 1.0
2½ x 2½ x 1 65 x 65 x 25	2.625 x 2.625 x 1.125 66.7 x 66.7 x 25.4	2.40 61.0	2.46 62.5	0.91 23.1	2.3 1.0
2½ x 2½ x 1¼ 65 x 65 x 32	2.625 x 2.625 x 1.375 66.7 x 66.7 x 34.9	2.52 64.0	2.63 66.8	0.97 24.6	2.5 1.1
2½ x 2½ x 1½ 65 x 65 x 40	2.625 x 2.625 x 1.625 66.7 x 66.7 x 38.1	2.70 68.6	2.74 69.6	1.09 27.7	2.7 1.2
3 x 3 x ¾ 80 x 80 x 20	3.125 x 3.125 x 0.875 79.4 x 79.4 x 21.0	2.45 62.2	2.64 67.1	0.75 19.0	2.9 1.3
3 x 3 x 1 80 x 80 x 25	3.125 x 3.125 x 1.125 79.4 x 79.4 x 25.4	2.54 64.5	2.85 72.4	0.91 23.1	3.0 1.4
3 x 3 x 1¼ 80 x 80 x 32	3.125 x 3.125 x 1.375 79.4 x 79.4 x 34.9	2.63 66.8	2.95 74.9	0.97 24.6	3.1 1.4
3 x 3 x 1½ 80 x 80 x 40	3.125 x 3.125 x 1.625 79.4 x 79.4 x 38.1	2.85 72.4	3.06 77.7	1.09 27.7	3.4 1.5
4 x 4 x ¾ 100 x 100 x 20	4.125 x 4.125 x 0.875 104.8 x 104.8 x 21.0	2.95 74.9	3.06 77.7	0.75 19.0	5.2 2.4
4 x 4 x 1 100 x 100 x 25	4.125 x 4.125 x 1.125 104.8 x 104.8 x 25.4	3.10 78.7	3.28 83.3	0.91 23.1	5.5 2.6
4 x 4 x 1¼ 100 x 100 x 32	4.125 x 4.125 x 1.375 104.8 x 104.8 x 34.9	3.25 82.5	3.53 89.7	0.97 24.6	5.7 2.6
4 x 4 x 1½ 100 x 100 x 40	4.125 x 4.125 x 1.625 104.8 x 104.8 x 38.1	3.35 85.1	3.71 94.2	1.09 27.7	6.1 2.8

Fig. 650
CTS Concentric Reducer

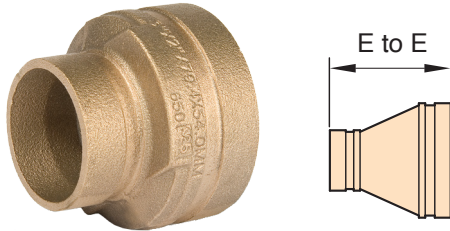

Nominal Size	Copper Tubing O.D.	End to End	Approx. Wt. Ea.
In./DN(mm)	In./mm	In./mm	Lbs./kg
2½ x 2 65 x 50	2.625 x 2.125 66.7 x 54.0	3.29 83.6	1.4 0.6
3 x 2 80 x 50	3.125 x 2.125 79.4 x 54.0	2.50 63.5	1.4 0.6
3 x 2½ 80 x 65	3.125 x 2.625 79.4 x 66.7	2.50 63.5	1.4 0.6
4 x 2 100 x 50	4.125 x 2.125 104.8 x 54.0	4.75 120.7	3.0 1.4
4 x 2½ 100 x 65	4.125 x 2.625 104.8 x 66.7	3.00 76.2	2.3 1.1
4 x 3 100 x 80	4.125 x 3.125 104.8 x 79.4	3.00 76.2	2.3 1.1
5 x 3 125 x 80	5.125 x 3.125 130.2 x 79.4	3.88 98.6	3.7 1.7
5 x 4 125 x 100	5.125 x 4.125 130.2 x 104.8	3.38 85.9	3.7 1.7
6 x 3 150 x 80	6.125 x 3.125 155.6 x 79.4	4.38 111.3	5.1 2.3
6 x 4 150 x 100	6.125 x 4.125 155.6 x 104.8	3.88 98.6	5.2 2.4
6 x 5 150 x 125	6.125 x 5.125 155.6 x 130.2	3.38 85.9	4.8 2.2
8 x 6 200 x 150	8.125 x 6.125 206.4 x 155.6	5.00 127	9.7 4.4

Note:

For information on larger sizes, contact an ASC Engineered Solutions Sales Representative.

See page 309 for CTS Fitting Specifications.

Fig. 652
CTS Concentric Reducer (Groove x Cup)



Nominal Size	Copper Tubing O.D.	End to End	Cup	Approx. Wt. Ea.
In./DN(mm)	In./mm	In./mm		Lbs./kg
2 x 1 50 x 25	2.125 x 1.125 54.0 x 25.4	2.70 68.6	0.91 23.1	0.5 0.2
2 x 1¼ 50 x 32	2.125 x 1.375 54.0 x 34.9	3.00 76.2	0.97 24.6	0.4 0.2
2 x 1½ 50 x 40	2.125 x 1.625 54.0 x 38.1	2.94 74.7	1.09 27.7	0.4 0.2
2½ x 1 65 x 25	2.625 x 1.125 66.7 x 25.4	3.25 82.6	0.91 23.1	0.5 0.2
2½ x 1¼ 65 x 32	2.625 x 1.375 66.7 x 34.9	3.52 89.4	0.97 24.6	0.6 0.3
2½ x 1½ 65 x 40	2.625 x 1.625 66.7 x 38.1	3.45 87.6	1.09 27.7	0.6 0.3
2½ x 2 65 x 50	2.625 x 2.125 66.7 x 54.0	3.38 85.9	1.34 34.0	0.6 0.3
3 x 1½ 80 x 40	3.125 x 1.625 79.4 x 38.1	3.68 93.5	1.09 27.7	0.7 0.3
3 x 2 80 x 50	3.125 x 2.125 79.4 x 54.0	4.10 104.1	1.34 34.0	1.0 0.5
4 x 2 100 x 50	4.125 x 2.125 104.8 x 54.0	4.75 120.7	1.34 34.0	1.4 0.6

CTS Copper Butterfly Valve Series 6700



Material Specifications

Valve Body:

ASTM B584 C89836; Bronze, Low Lead

Disc:

ASTM A536 Gr. 65-45-12; Ductile Iron

Disc Encapsulation:

Grade "EP" EPDM Rubber: Service temperature range: -40°F to +250°F (-40°C to +121°C)

Recommended for water service, diluted acids, alkaline solutions, and oil-free air.

NOT RECOMMENDED FOR USE IN PETROLEUM APPLICATIONS.

Upper and Lower Shafts:

Stainless Steel Type 17-4PH; ASTM A564

Certifications:

ANSI/NSF61 for use in Cold +86F(+30C) and Hot +180F(+82C) potable water systems. Annex G. UPC.

The lever handle bronze body butterfly valve is designed for use with grooved copper tubing (CTS), fittings and couplings. This valve features a 10 position lever handle, bronze body and EPDM rubber encapsulated disc. Both bronze valve body and the EPDM rubber disc obtained certification to ANSI/NSF 61 for use in potable water systems and is rated to 300 PSI.

CTS Copper Butterfly Valve Fig. Series 6700

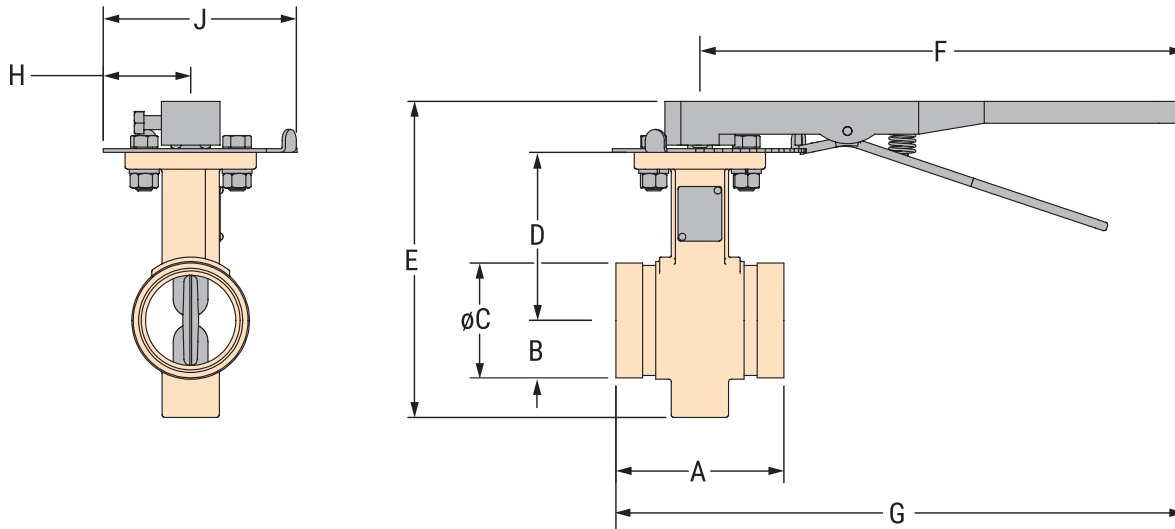

CTS Copper Butterfly Valve Dimensions

Nominal Size	Copper Tube Diameter	Dimensions									Weight	
		A	B	C	D	E	F	G	H	J		
2½	In./mm	In./mm	In./mm	In./mm	In./mm	In./mm	In./mm	In./mm	In./mm	In./mm	In./mm	Lbs./kg
3	2.625	3.77	2.22	2.63	3.83	7.20	10.50	12.39	2.00	4.43	4	
	66.7	95.8	56.4	66.7	97.3	182.5	266.7	314.6	50.8	112.5	1.8	
4	3.125	3.77	2.60	3.13	4.08	7.84	10.50	12.39	2.00	4.43	5	
	79.4	95.8	65.9	79.4	130.5	198.2	266.7	314.6	50.8	112.5	2.3	
5	4.125	4.63	3.10	4.13	4.72	8.97	10.50	12.81	2.00	4.43	8	
	104.8	117.6	78.7	104.9	119.9	227.8	266.7	325.5	50.8	112.5	3.8	
6	5.125	5.88	3.85	5.13	5.22	10.27	10.50	13.44	2.00	4.43	14	
	130.2	149.4	97.8	130.2	132.6	260.9	266.7	341.4	50.8	112.5	6.4	
6	6.125	5.88	4.36	6.13	5.75	11.31	10.50	13.44	2.00	4.43	18	
	155.6	149.4	110.8	155.6	146.2	287.3	266.7	341.4	50.8	112.5	8.1	

CTS Copper Butterfly Valve Series 6700

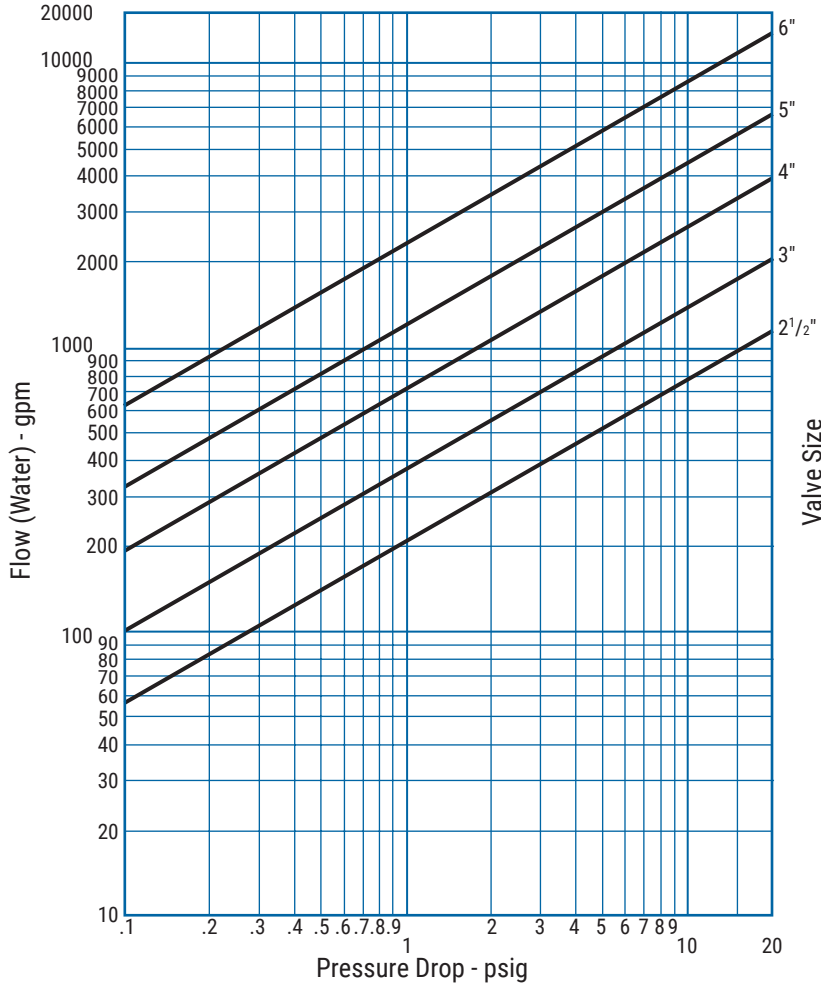

Values for flow of water at +60°F (+16°C)

$$C_v = \frac{Q}{\sqrt{\Delta P}}$$

Where: C_v = Flow coefficient

Q = Flow (GPM)

ΔP = Pressure drop (psi)

CTS Copper Butterfly (Ordering Information)

Sample Part Number	4"	A	N	67	2	1-	3
4" AN6721-3 --->	Size	Body Style	Body Type	Series	Disc Coating	Operator	Shaft
	2 1/2" - 6"	A	Bronze	6700	2 - EPDM (Grade EP)	1 - 10 Pos. Handlever	3 - Stainless Steel Type 17-4PH

Fig. 7088 Fig. 7089 Fig. 7090 Di-Electric Pipe Connection



Material Specifications

Housing

Steel Tube to ASTM A 513, Zinc Plated

Liner

Polypropylene

Threads

ASME B1.20.1

Grooves

Gruvlok Cut Groove Dimensions (Refer to Technical Data Section of the Gruvlok Catalog)

Installation & Assembly

For installation and assembly of grooved-end connections, see “Fig. 7400 Gruvlok Rigidlite Coupling” and “Fig. 7012 Gruvlok Flange”

The Fig 7088, 7089, & 7090 di-electric nipple inhibits the formation of galvanic corrosion between dissimilar piping metals. The di-electric nipples offer a variety of connections from thread to thread, thread to groove, or groove to groove all for IPS pipe sizes.

The di-electric fittings are designed to meet ASTM F 492 for continuous use at temperatures from -40°F to 230°F (-40°C to 110°C and pressures up to 300 psi (20.7 bar). The di-electric pipe connections will achieve a dielectric waterway in potable water and appropriate HVAC applications.

- Introduction
- Couplings
- Outlets
- Fittings
- Valves & Accessories
- High Pressure
- CTS Copper System
- Di-Electric Nipples
- Plain-End Fittings
- HDPE Couplings
- Sock-It® Fittings
- Stainless Steel Method
- Roll Groovers
- Installation & Assembly
- Special Coatings
- Design Services
- Technical Data
- Master Format 3 Part Specs.
- Pictorial Index

Fig. 7088
Groove by Thread

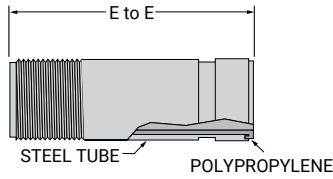

Fig. 7089
Groove by Groove

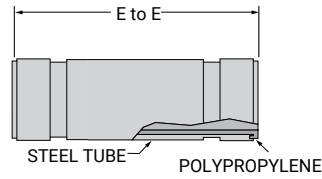
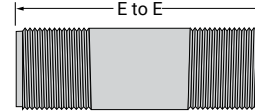

Fig. 7090
Thread by Thread



Nom. IPS Pipe Size	O.D.	Max Working Pressure	Fig. 7088 Thread x Groove		Fig. 7089 Groove x Groove		Fig. 7090 Thread x Thread	
			E to E	Approx. Wt. Ea.	E to E	Approx. Wt. Ea.	E to E	Approx. Wt. Ea.
NIPS/DN	In./mm	PSI/bar	In./mm	Lbs./Kg	In./mm	Lbs./Kg	In./mm	Lbs./Kg
1/2 15	0.840 21.3	300 20.7	- -	- -	- -	- -	3 76.2	0.20 0.1
3/4 20	1.050 26.7	300 20.7	- -	- -	- -	- -	3 76.2	0.20 0.1
1 25	1.315 33.7	300 20.7	4 101.6	0.30 0.1	- -	- -	4 101.6	0.30 0.1
1 1/4 32	1.660 42.4	300 20.7	4 101.6	0.60 0.3	- -	- -	4 101.6	0.60 0.3
1 1/2 40	1.900 48.3	300 20.7	4 101.6	0.80 0.4	- -	- -	4 101.6	0.80 0.4
2 50	2.375 60.3	300 20.7	4 101.6	1.00 0.5	4 101.6	1.00 0.5	4 101.6	1.00 0.5
2 1/2 65	2.875 73.0	300 20.7	6 152.4	1.60 0.7	6 152.4	1.60 0.7	6 152.4	01.6 0.7
3 80	3.500 88.9	300 20.7	6 152.4	2.00 0.9	6 152.4	2.00 0.9	6 152.4	2.00 0.9
4 100	4.500 114.3	300 20.7	6 152.4	4.50 2.0	6 152.4	4.50 2	- -	- -

Notes:

Figure 7088 available in Nominal Pipe Sizes 1" through 4" only.
 Figure 7089 available in Nominal Pipe Sizes 2" through 4" only.
 Figure 7090 available in Nominal Pipe Sizes 1/2" through 3" only.

Gruvlok® DI-LOK™ CTS x IPS Groove Di-Electric Fitting Fig. 7091



The Gruvlok Fig. 7091 DI-LOK Fitting prevents the formation of a galvanic cell between grooved end steel pipe and copper tube. The separation of copper from steel by the fitting virtually eliminates the galvanic cell created by the dissimilar metals.

The DI-LOK Fitting is designed for use at temperatures from -40°F to 230°F (-40°C to 110°C) and pressures to 300 PSI (20.7 bar) in a wide range of applications.

Material Specifications

Housing

Seamless Carbon Steel to ASTM A106

Coating

Nylon conforming to ANSI/NSF-61

Introduction

Couplings

Outlets

Fittings

Valves & Accessories

High Pressure

CTS Copper System

Di-Electric Nipples

Plain-End Fittings

HDPE Couplings

Socket-It® Fittings

Stainless Steel Method

Roll Groovers

Installation & Assembly

Special Coatings

Design Services

Technical Data

Master Format 3 Part Specs.

Pictorial Index

Gruvlok® DI-LOK™ CTS x IPS Groove Di-Electric Fitting Fig. 7091

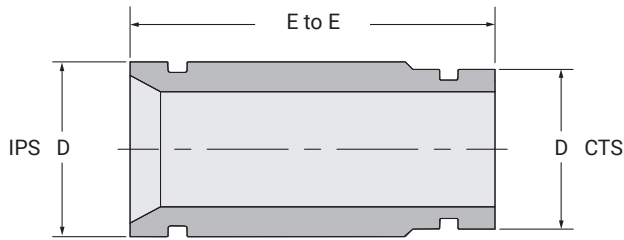

Nominal Size	Copper (CTS)	Steel (IPS)	End to End	Approx. Wt. Ea.
	D Actual	D Actual		
IPS	In./mm	In./mm	In./mm	Lbs./kg
2	2.125	2.375	4.0	1.76
50	53.98	60.33	101.60	0.80
2½	2.625	2.875	6.0	3.66
65	66.68	73.03	152.40	1.66
3	3.125	3.500	6.0	5.23
80	79.38	88.90	152.40	2.37
4	4.125	4.500	6.0	6.88
100	104.78	114.30	152.40	3.12
6	6.125	6.625	6.0	13.80
150	155.58	168.28	152.40	6.26
8	8.125	8.625	6.0	18.91
200	206.38	219.07	152.40	8.58

Roughneck® Coupling Fig. 7005

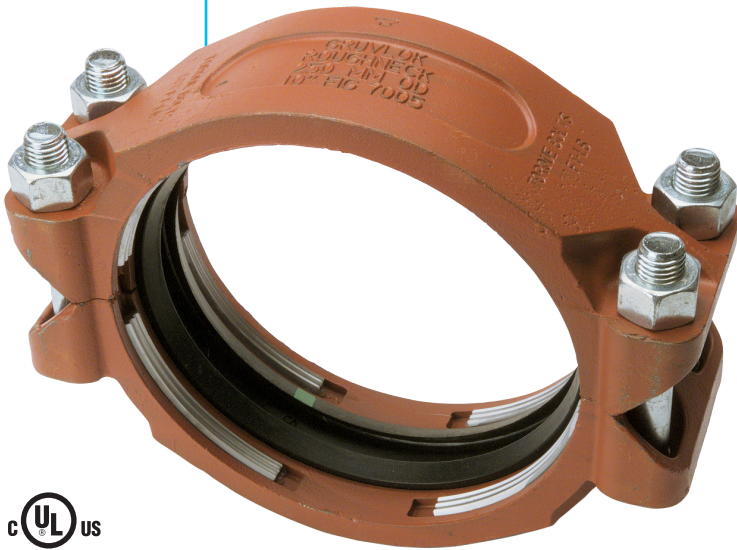

The Fig. 7005 Roughneck Coupling is an effective and reliable way of joining plain-end or beveled end pipe. The Roughneck Coupling is ideal for use in a variety of applications including mining, process piping, manifold piping and oilfield services. The unique gripper action provides a positive pipe joint and allows for working pressure ratings up to 750 PSI (52 bar for schedule 40 pipe).

For Listings/Approval Details and Limitations, visit our website at www.asc-es.com or contact an ASC Engineered Solutions™ Sales Representative.

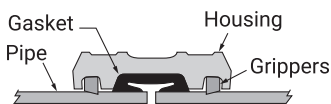

Working pressure and end load are based on a properly assembled Roughneck coupling with bolts fully torqued to the above specifications, on plain-end or beveled standard wall steel pipe and Gruvlok Plain-End Fittings.

Roughneck Couplings are designed to be used on plain-end pipe and Gruvlok Plain-End Fittings only. For externally coated pipe applications, contact an ASC Representative.

Not recommended for use on steel pipe with a hardness greater than 150 Brinell, Stainless Steel, plastic, HDPE, cast iron or other brittle pipe.

Not recommended for pipe schedule transitioning.

Suitable for schedule 10 steel pipe, for pressure ratings see Technical Data section of the Gruvlok Catalog.

*Bolt torque ratings shown must be applied at installation.

Material Specifications

Housing

Ductile Iron conforming to ASTM A536, Grade 65-45-12 or Malleable Iron conforming to ASTM A47, Grade 32510.

Bolts

SAE J429, Grade 5, Zinc Electroplated

Heavy Hex Nuts

ASTM A563, Grade A, Zinc Electroplated

Grippers

2"-8" heat treated, electroplated carbon steel.

10"-16" heat treated stainless steel.

Coatings

Rust inhibiting paint

Color: Orange (Standard)

2" - 12" Hot Dipped Zinc Galvanized (Optional)

Other Colors Available (IE: RAL3000 and RAL9000).

For other Coating requirements contact an ASC Engineered Solutions™ Representative.

Gasket

Grade E (EPDM) or

Grade T (Nitrile) Elastomers with properties as designed by ASTM D2000 for each gasket grade.

- Introduction
- Couplings
- Outlets
- Fittings
- Valves & Accessories
- High Pressure
- CTS Copper System
- DI-Electric Nipples
- Plain-End Fittings
- HDPE Couplings
- Socket-Fittings
- Stainless Steel Method
- Roll Groovers
- Installation & Assembly
- Special Coatings
- Design Services
- Technical Data
- Master Format 3 Part Specs.
- Pictorial Index

Roughneck® Coupling Fig. 7005

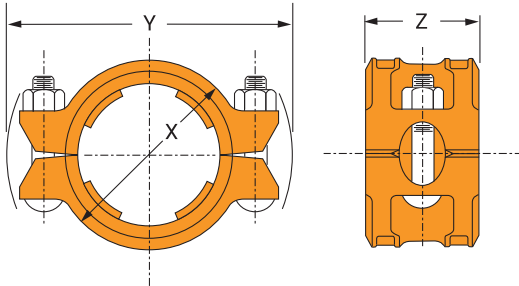

Nominal Size	O.D.	Max. Wk. Pressure	Max. End Load	No. of Grippers	Coupling Dimensions			Coupling Bolts		Specified Torque §		Approx. Wt. Ea.
					X	Y	Z	Qty.	Size	Min.	Max.	
In./DN(mm)	In./mm	PSI/bar	Lbs./kN		In./mm	In./mm	In./mm		In./mm	Ft.-Lbs./N-m	Ft.-Lbs./N-m	Lbs./kg
2	2.375	750	3,323	8	3 ³ / ₄	6 ³ / ₈	3 ¹ / ₂	2	5 ⁵ / ₈ x 3 ¹ / ₄	150	190	6.6
50	60.3	51.7	14.78		95	162	89		—	203	257	3.0
2 ¹ / ₂	2.875	600	3,895	8	4 ¹ / ₄	7 ¹ / ₈	3 ¹ / ₂	2	5 ⁵ / ₈ x 3 ¹ / ₄	150	190	7.4
65	73.0	41.4	17.33		108	181	89		—	203	257	3.4
3	3.500	600	5,773	8	4 ⁷ / ₈	8 ¹ / ₈	3 ¹ / ₂	2	3 ³ / ₄ x 4 ¹ / ₂	200	250	10.5
80	88.9	41.4	25.68		124	206	89		—	271	339	4.8
4	4.500	450	7,157	8	6 ³ / ₈	9 ³ / ₈	4 ¹ / ₈	2	3 ³ / ₄ x 4 ¹ / ₂	200	250	16.4
100	114.3	31.0	31.84		162	238	105		—	271	339	7.4
5	5.563	350	8,507	8	7 ¹ / ₂	11 ¹ / ₈	4 ³ / ₈	2	7 ⁷ / ₈ x 5	250	300	23.8
125	141.3	24.1	37.84		191	283	111		—	339	406	10.8
6	6.625	300	10,341	12	8 ³ / ₄	12 ⁷ / ₈	4 ³ / ₈	2	1 x 6	250	300	31.7
150	168.3	20.7	46.00		222	327	111		—	339	406	14.4
8	8.625	300	17,528	12	10 ⁷ / ₈	14 ¹ / ₂	4 ¹ / ₂	4	7 ⁷ / ₈ x 5	250	300	38.6
200	219.1	20.7	77.97		276	368	114		—	339	406	17.5
10	10.750	300	27,229	8	12 ⁵ / ₈	18	5 ³ / ₈	4	1 x 6 ¹ / ₂	500	600	40
250	273.1	20.7	121.12		321	457	137		—	678	814	18.1
12	12.750	250	31,919	12	14 ⁷ / ₈	20 ¹ / ₄	5 ³ / ₈	4	1 x 6 ¹ / ₂	550	700	56
300	323.9	17.2	141.98		378	514	137		—	746	949	25.4
14	14.000	200	30,788	12	16 ³ / ₄	22 ¹ / ₈	6 ¹ / ₄	4	1 x 6 ¹ / ₂	550	700	88
350	355.6	13.8	136.95		425	562	159		—	746	949	39.9
16	16.000	150	30,159	12	18 ³ / ₄	24	6 ¹ / ₄	4	1 x 6 ¹ / ₂	550	700	95
400	406.4	10.3	134.15		476	610	159		—	746	949	43.1

Note:

For additional details see “Coupling Data Chart Notes” in the Introduction Section of the Gruvlok Catalog.

§ – For additional Bolt Torque information, see the Technical Data Section of the Gruvlok Catalog.

See Installation & Assembly directions in the Technical Data Section of the Gruvlok Catalog.

Not for use in copper or PVC systems.

Fig. 7050P 90° Elbow
Fig. 7051P 45° Elbow
Fig. 7060P Tee

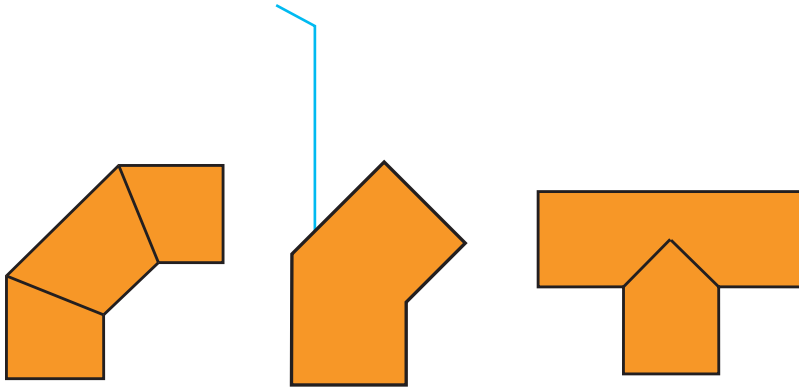

Fig. 7050P

Fig. 7051P

Fig. 7060P

Gruvlok plain-end fittings are manufactured to provide minimum pressure drop and uniform flow. Fittings are designed for use with the Fig. 7005 Roughneck Couplings only.

Gruvlok plain-end fittings are available in sizes through 8" nominal pipe size in a variety of styles. Depending on size and configuration, fittings are either segment-welded steel or forged steel.

Fittings are normally coated with a rust inhibiting paint. Other coatings including Hot Dipped Zinc Galvanizing, are available.

Material Specifications

Segment Welded Steel Fittings

Sizes 2" - 4" Carbon Steel pipe conforming to ASTM A53, Type "F"

Sizes 5" - 8"; Carbon Steel pipe conforming to ASTM A53, Type "E" or "S", Grade "B"

Steel Fittings

Forged Steel conforming to ASTM A106

Adapter Flanges

Class 150 - Carbon Steel conforming to ANSI B16.5

Class 300 - Carbon Steel conforming to ANSI B16.5

Fitting Size

Nominal Size	O.D.
In./DN(mm)	In./mm
2	2.375
50	60.3
2½	2.875
65	73.0
3	3.500
80	88.9
3½	4.000
90	101.6
4	4.500
100	114.3
5	5.563
140	141.3
6	6.625
150	168.3
8	8.625
200	219.1

Note:

The Fitting Size Chart is used to determine the O.D. of the pipe that the fittings is to be used with. Gruvlok Fittings are identified by either the Nominal size in inches or the Pipe O.D. In./mm.

- Introduction
- Couplings
- Outlets
- Fittings
- Valves & Accessories
- High Pressure
- CTS Copper System
- DI-Electric Nipples
- Plain-End Fittings
- HDPE Couplings
- Socket-It® Fittings
- Stainless Steel Method
- Roll Groovers
- Installation & Assembly
- Special Coatings
- Design Services
- Technical Data
- Master Format 3 Part Specs.
- Pictorial Index

Fig. 7050P
90° Elbow

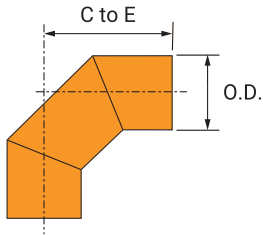

Nominal Size	O.D.	Center to End	Approx. Wt. Ea.
In./DN(mm)	In./mm	In./mm	Lbs./kg
2	2.375	4 ³ / ₄	2.7
50	60.3	121	1.2
2½	2.875	5½	4.8
65	73.0	140	2.2
3	3.500	6¼	7.2
80	88.9	159	3.3
4	4.500	7¾	12.3
100	114.3	197	5.6
5	5.563	9½	13.4
125	141.3	241	6.1
6	6.625	11	31
150	168.3	279	14.1
8	8.625	11	38.7
200	219.1	279	17.6

Fig. 7051P
45° Elbow

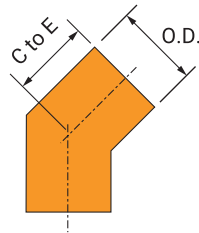

Nominal Size	O.D.	Center to End	Approx. Wt. Ea.
In./DN(mm)	In./mm	In./mm	Lbs./kg
2	2.375	3½	2.0
50	60.3	79	0.9
2½	2.875	3½	3.5
65	73.0	89	1.6
3	3.500	3¾	4.8
80	88.9	95	2.2
4	4.500	4¼	8.0
100	114.3	108	3.6
5	5.563	5½	9.2
125	141.3	130	4.2
6	6.625	5¾	18.5
150	168.3	146	8.4
8	8.625	6	24.9
200	219.1	152	11.3

Fig. 7060P
Tee

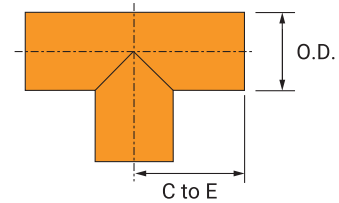

Nominal Size	O.D.	Center to End	Approx. Wt. Ea.
In./DN(mm)	In./mm	In./mm	Lbs./kg
2	2.375	4¼	3.5
50	60.3	108	1.6
2½	2.875	4¾	6.2
65	73.0	121	2.8
3	3.500	5½	8.6
80	88.9	130	3.9
4	4.500	5¾	13.8
100	114.3	149	6.3
5	5.563	6¾	21.7
125	141.3	175	9.8
6	6.625	7¾	30.9
150	168.3	194	14.0
8	8.625	10	61.1
200	219.1	254	27.7

- Fig. 7068P** Cross
- Fig. 7069P** 45° Lateral
- Fig. 7071P** 90° True Wye

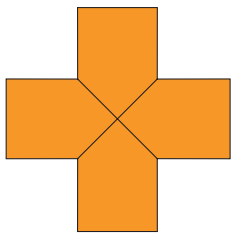

Fig. 7068P

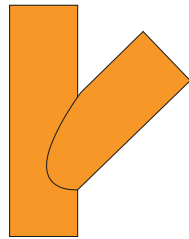

Fig. 7069P

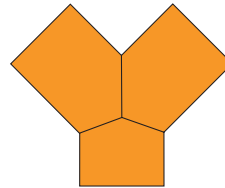

Fig. 7071P

Gruvlok plain-end fittings are manufactured to provide minimum pressure drop and uniform flow. Fittings are designed for use with the Fig. 7005 Roughneck Couplings only.

Gruvlok plain-end fittings are available in sizes through 8" nominal pipe size in a variety of styles. Depending on size and configuration, fittings are either segment-welded steel or forged steel.

Fittings are normally coated with a rust inhibiting paint. Other coatings including Hot Dipped Zinc Galvanizing, are available.

Material Specifications

Segment Welded Steel Fittings

Sizes 2" - 4" Carbon Steel pipe conforming to ASTM A 53, Type "F";
 Sizes 5" - 8"; Carbon Steel pipe conforming to ASTM A 53, Type "E" or "S", Grade "B".

Steel Fittings

Forged Steel conforming to ASTM A 106.

Adapter Flanges

Class 150 - Carbon Steel conforming to ANSI B16.5
 Class 300 - Carbon Steel conforming to ANSI B16.5

Fitting Size

Nominal Size	O.D.
In./DN(mm)	In./mm
2 50	2.375 60.3
2½ 65	2.875 73.0
3 80	3.500 88.9
3½ 90	4.000 101.6
4 100	4.500 114.3
5 140	5.563 141.3
6 150	6.625 168.3
8 200	8.625 219.1

Note:

The Fitting Size Chart is used to determine the O.D. of the pipe that the fittings is to be used with. Gruvlok Fittings are identified by either the Nominal size in inches or the Pipe O.D. In./mm.

Fig. 7068P
Cross

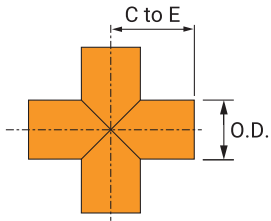

Nominal Size	O.D.	Center to End	Approx. Wt. Ea.
In./DN(mm)	In./mm	In./mm	Lbs./kg
2	2.375	4 1/4	4.4
50	60.3	108	2.0
2 1/2	2.875	4 3/4	7.8
65	73.0	121	3.5
3	3.500	5 1/8	10.7
80	88.9	130	4.9
4	4.500	5 7/8	17.0
100	114.3	149	7.7
5	5.563	6 7/8	26.7
125	141.3	175	12.1
6	6.625	7 5/8	37.7
150	168.3	194	17.1
8	8.625	10	74.6
200	219.1	254	33.8

Fig. 7069P
45° Lateral

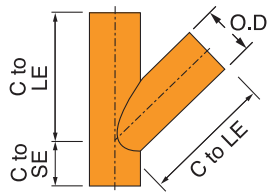

Nominal Size	O.D.	Center to Long End	Center to Short End	Approx. Wt. Ea.
In./DN(mm)	In./mm	In./mm	In./mm	Lbs./kg
2	2.375	7 1/4	2 3/4	5.1
50	60.3	184	70	2.3
2 1/2	2.875	7 3/4	3	9.5
65	73.0	197	76	4.3
3	3.500	8 3/4	3 1/4	12.8
80	88.9	222	83	5.8
4	4.500	10 3/4	3 3/4	22.2
100	114.3	273	95	10.1
5	5.563	12 3/4	4	38.0
125	141.3	324	102	17.2
6	6.625	14	4 1/2	54.0
150	168.3	356	114	24.5
8	8.625	18	6	92.0
200	219.1	457	152	41.7

Fig. 7071P
90° True Wye

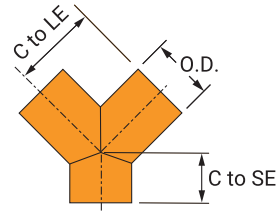

Nominal Size	O.D.	Center to Long End	Center to Short End	Approx. Wt. Ea.
In./DN(mm)	In./mm	In./mm	In./mm	Lbs./kg
2	2.375	4 1/4	2 3/4	3.5
50	60.3	108	70	1.6
2 1/2	2.875	4 3/4	3	6.2
65	73.0	121	76	2.8
3	3.500	5 1/8	3 1/4	8.5
80	88.9	130	83	3.9
4	4.500	5 7/8	3 3/4	14.0
100	114.3	149	95	6.4
5	5.563	6 7/8	4	21.6
125	141.3	175	102	9.8
6	6.625	7 5/8	4 1/2	31.2
150	168.3	194	114	14.2
8	8.625	10	6	53.6
200	219.1	254	152	24.3

- Fig. 7061P** Reducing Tee
- Fig. 7084P** Flange Nipples (Plain-End x Class 150)
- Fig. 7085P** Flange Nipples (Plain-End x Class 300)

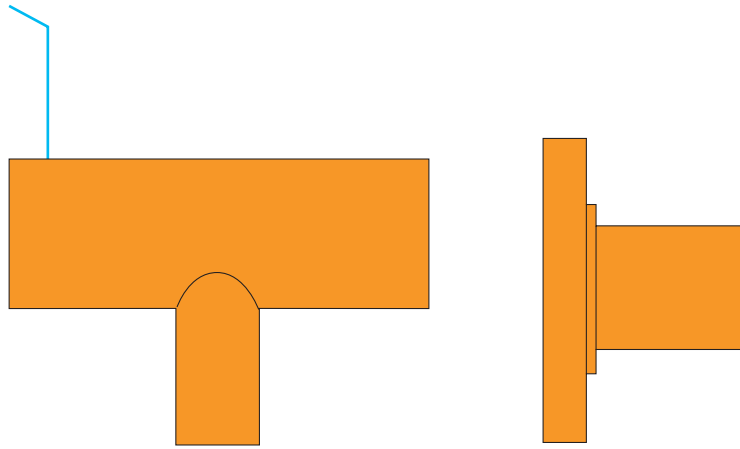

Fig. 7061P

Fig. 7084P & 7085P

Gruvlok plain-end fittings are manufactured to provide minimum pressure drop and uniform flow. Fittings are designed for use with the Fig. 7005 Roughneck Couplings only.

Gruvlok plain-end fittings are available in sizes through 8" nominal pipe size in a variety of styles. Depending on size and configuration, fittings are either segment-welded steel or forged steel.

Fittings are normally coated with a rust inhibiting paint. Other coatings including Hot Dipped Zinc Galvanizing, are available.

Material Specifications

Segment Welded Steel Fittings

Sizes 2" - 4" Carbon Steel pipe conforming to ASTM A53, Type "F";
 Sizes 5" - 8"; Carbon Steel pipe conforming to ASTM A53, Type "E" or "S", Grade "B".

Steel Fittings

Forged Steel conforming to ASTM A106.

Adapter Flanges

Class 150 - Carbon Steel conforming to ANSI B16.5
 Class 300 - Carbon Steel conforming to ANSI B16.5

Fitting Size

Nominal Size	O.D.
In./DN(mm)	In./mm
2	2.375
50	60.3
2½	2.875
65	73.0
3	3.500
80	88.9
3½	4.000
90	101.6
4	4.500
100	114.3
5	5.563
140	141.3
6	6.625
150	168.3
8	8.625
200	219.1

Note:

The Fitting Size Chart is used to determine the O.D. of the pipe that the fittings is to be used with. Gruvlok Fittings are identified by either the Nominal size in inches or the Pipe O.D. In./mm.

Fig. 7061P
Reducing Tee

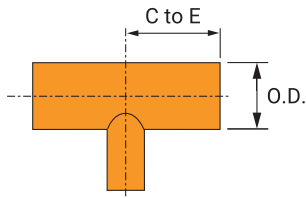

Nominal Size	Center to End	Approx. Wt. Ea.
In./DN(mm)	In./mm	Lbs./kg
3 x 3 x 2	5½	7.1
80 x 80 x 50	140	3.2
4 x 4 x 2	5⅞	11.3
100 x 100 x 50	149	5.1
4 x 4 x 2½	5⅞	11.6
100 x 100 x 65	149	5.3
4 x 4 x 3	5⅞	11.9
100 x 100 x 80	149	5.4
6 x 6 x 2	7⅝	24.6
150 x 150 x 50	194	11.2
6 x 6 x 3	7⅝	25.4
150 x 150 x 80	194	11.5
6 x 6 x 4	7⅝	26.2
150 x 150 x 100	194	11.9
8 x 8 x 2	10	42.0
200 x 200 x 50	254	19.1
8 x 8 x 3	10	44.0
200 x 200 x 80	254	20.0
8 x 8 x 4	10	46.0
200 x 200 x 100	254	20.9
8 x 8 x 5	10	48.0
200 x 200 x 125	254	21.8
8 x 8 x 6	10	50.0
200 x 200 x 150	254	22.7
10 x 10 x 4	11½	74.0
250 x 250 x 100	292	33.6
10 x 10 x 6	11½	78.0
250 x 250 x 150	292	35.4
10 x 10 x 8	11½	86.0
250 x 250 x 200	292	39.0
12 x 12 x 6	13½	112.0
300 x 300 x 150	343	50.8
12 x 12 x 8	13½	118.0
300 x 300 x 200	343	53.5
12 x 12 x 10	13½	130.0
300 x 300 x 250	343	59.0

Fig. 7084P
Flange Nipples
Plain-End x Class 150)

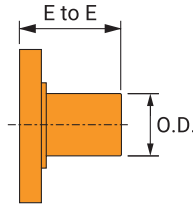

Nominal Size	O.D.	Center to End	Approx. Wt. Ea.
In./DN(mm)	In./mm	In./mm	Lbs./kg
2	2.375	4	6.0
50	60.3	102	2.7
2½	2.875	4	9.2
65	73.0	102	4.2
3	3.500	4	10.4
80	88.9	102	4.7
4	4.500	6	19.1
100	114.3	152	8.7
5	5.563	6	23.0
125	141.3	152	10.4
6	6.625	6	29.5
150	168.3	152	13.4
8	8.625	6	43.5
200	219.1	152	19.7

Fig. 7085P
Flange Nipples
(Plain-End x Class 300)

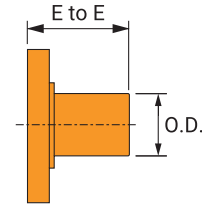

Nominal Size	O.D.	Center to End	Approx. Wt. Ea.
In./DN(mm)	In./mm	In./mm	Lbs./kg
2	2.375	4	8.2
50	60.3	102	3.7
2½	2.875	4	11.9
65	73.0	102	5.4
3	3.500	4	15.5
80	88.9	102	7.0
4	4.500	6	28.0
100	114.3	152	12.7
5	5.563	6	35.0
125	141.3	152	15.9
6	6.625	6	50.0
150	168.3	152	22.7
8	8.625	6	72.0
200	219.1	152	32.7

Fig. 7050LRP 90° Long Radius Elbow
Fig. 7051LRP 45° Long Radius Elbow
Fig. 7075P Bull Plug

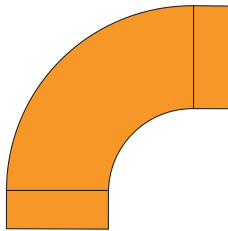

Fig. 7050LRP

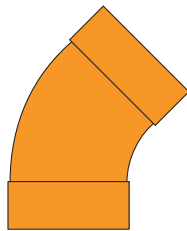

Fig. 7051LRP

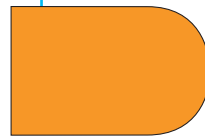

Fig. 7075P

Gruvlok plain-end fittings are manufactured to provide minimum pressure drop and uniform flow. Fittings are designed for use with the Fig. 7005 Roughneck Couplings only.

Gruvlok plain-end fittings are available in sizes through 8" nominal pipe size in a variety of styles. Depending on size and configuration, fittings are either segment-welded steel or forged steel.

Fittings are normally coated with a rust inhibiting paint. Other coatings including Hot Dipped Zinc Galvanizing, are available.

Material Specifications

Segment Welded Steel Fittings

Sizes 2" - 4" Carbon Steel pipe conforming to ASTM A53, Type "F";

Sizes 5" - 8"; Carbon Steel pipe conforming to ASTM A53, Type "E" or "S", Grade "B".

Steel Fittings

Forged Steel conforming to ASTM A106.

Adapter Flanges

Class 150 - Carbon Steel conforming to ANSI B16.5

Class 300 - Carbon Steel conforming to ANSI B16.5

Fitting Size

Nominal Size	O.D.	Nominal Size	O.D.
In./DN(mm)	In./mm	In./DN(mm)	In./mm
2	2.375	4	4.500
50	60.3	100	114.3
2½	2.875	5	5.563
65	73.0	140	141.3
3	3.500	6	6.625
80	88.9	150	168.3
3½	4.000	8	8.625
90	101.6	200	219.1

Note:

The Fitting Size Chart is used to determine the O.D. of the pipe that the fittings is to be used with. Gruvlok® Fittings are identified by either the Nominal size in inches or the Pipe O.D. In./mm.

Fig. 7050LRP
90° Long Radius Elbow

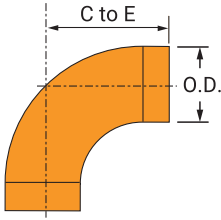

Nominal Size	O.D.	Center to End	Approx. Wt. Ea.
In./DN(mm)	In./mm	In./mm	Lbs./kg
2	2.375	5	2.5
50	60.3	127	1.1
2½	2.875	5¾	4.9
65	73.0	146	2.2
3	3.500	6½	6.5
80	88.9	165	2.9
4	4.500	8	11.5
100	114.3	203	5.2
5	5.563	9¾	21.5
125	141.3	248	9.8
6	6.625	11¼	28.5
150	168.3	286	12.9
8	8.625	15	56.7
200	219.1	381	25.7

Fig. 7051LRP
45° Long Radius Elbow

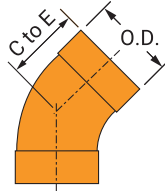

Nominal Size	O.D.	Center to End	Approx. Wt. Ea.
In./DN(mm)	In./mm	In./mm	Lbs./kg
2	2.375	3⅞	1.8
50	60.3	86	0.8
2½	2.875	3¾	3.6
65	73.0	95	1.6
3	3.500	4.0	4.5
80	88.9	102	2.0
4	4.500	4½	7.5
100	114.3	114	3.4
5	5.563	5⅞	13.8
125	141.3	137	6.3
6	6.625	6.0	17.3
150	168.3	152	7.8
8	8.625	8.0	34.0
200	219.1	203	15.4

Fig. 7075P
Bull Plug

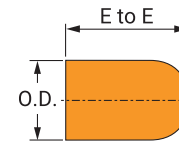

Nominal Size	O.D.	Center to End	Approx. Wt. Ea.
In./DN(mm)	In./mm	In./mm	Lbs./kg
2	2.375	4	2.3
50	60.3	102	1.0
2½	2.875	5	3.0
65	73.0	127	1.4
3	3.500	6	4.5
80	88.9	152	2.0
4	4.500	7	7.5
100	114.3	178	3.4
5	5.563	8½	12.5
125	141.3	216	5.7
6	6.625	10	17.0
150	168.3	254	7.7
8	8.625	11	29.0
200	219.1	279	13.2

- Fig. 7080P** Plain x Grooved
- Fig. 7081P** Plain x Thread
- Fig. 7082P** Plain x Bevel

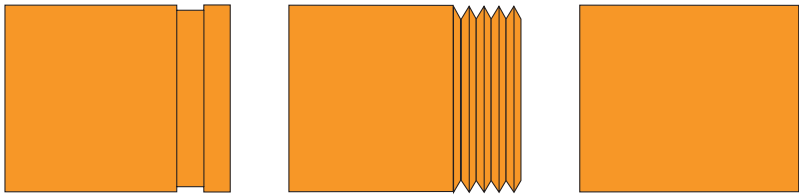

Fig. 7080P

Fig. 7081P

Fig. 7082P

Gruvlok plain-end fittings are manufactured to provide minimum pressure drop and uniform flow. Fittings are designed for use with the Fig. 7005 Roughneck Couplings only.

Gruvlok plain-end fittings are available in sizes through 8" nominal pipe size in a variety of styles. Depending on size and configuration, fittings are either segment-welded steel or forged steel.

Fittings are normally coated with a rust inhibiting paint. Other coatings including Hot Dipped Zinc Galvanizing, are available.

Material Specifications

Segment Welded Steel Fittings

Sizes 2" - 4" Carbon Steel pipe conforming to ASTM A 53, Type "F";
 Sizes 5" - 8"; Carbon Steel pipe conforming to ASTM A 53, Type "E" or "S", Grade "B".

Steel Fittings

Forged Steel conforming to ASTM A 106.

Adapter Flanges

Class 150 - Carbon Steel conforming to ANSI B16.5

Class 300 - Carbon Steel conforming to ANSI B16.5

Fitting Size

Nominal Size	O.D.
In./DN(mm)	In./mm
2	2.375
50	60.3
2½	2.875
65	73.0
3	3.500
80	88.9
3½	4.000
90	101.6
4	4.500
100	114.3
5	5.563
140	141.3
6	6.625
150	168.3
8	8.625
200	219.1

Note:

The Fitting Size Chart is used to determine the O.D. of the pipe that the fittings is to be used with. Gruvlok Fittings are identified by either the Nominal size in inches or the Pipe O.D. In./mm.

- Introduction
- Couplings
- Outlets
- Fittings
- Valves & Accessories
- High Pressure
- CTS Copper System
- DI-Electric Nipples
- Plain-End Fittings**
- HDPE Couplings
- Sock-It® Fittings
- Stainless Steel Method
- Roll Groovers
- Installation & Assembly
- Special Coatings
- Design Services
- Technical Data
- Master Format 3 Part Specs.
- Pictorial Index

Fig. 7080P
Plain x Grooved

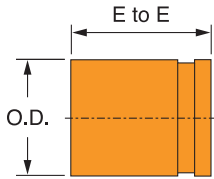

Fig. 7081P
Plain x Thread

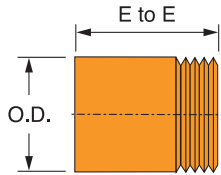
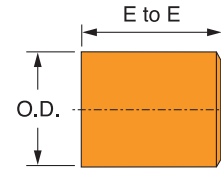
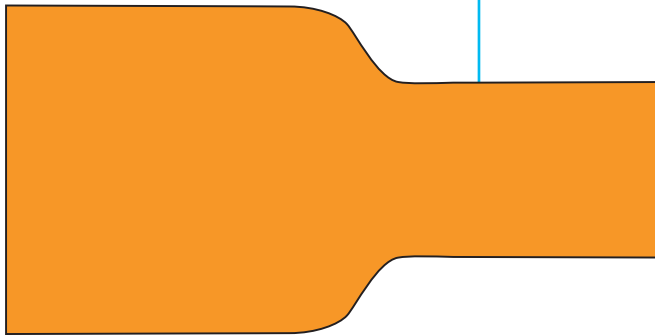

Fig. 7082P
Plain x Bevel



Nominal Size	O.D.	End to End	Approx. Wt. Ea.
In./DN(mm)	In./mm	In./mm	Lbs./kg
2 50	2.375 60.3	4 & 6 102 & 152	1.2 0.5
2½ 65	2.875 73.0	4 & 6 102 & 152	1.9 0.9
3 80	3.500 88.9	4 & 6 102 & 152	2.5 1.1
4 100	4.500 114.3	4 & 6 102 & 152	5.5 2.5
6 150	6.625 168.3	4 & 6 102 & 152	9.5 4.3
8 200	8.625 219.1	4 & 6 102 & 152	14.2 6.4

Fig. 7077P Swaged Nipples



Gruvlok plain-end fittings are manufactured to provide minimum pressure drop and uniform flow. Fittings are designed for use with the Fig. 7005 Roughneck Couplings only.

Gruvlok plain-end fittings are available in sizes through 8" nominal pipe size in a variety of styles. Depending on size and configuration, fittings are either segment-welded steel or forged steel.

Fittings are normally coated with a rust inhibiting paint. Other coatings including Hot Dipped Zinc Galvanizing, are available.

Material Specifications

Segment Welded Steel Fittings

Sizes 2" - 4" Carbon Steel pipe conforming to ASTM A53, Type "F";
 Sizes 5" - 8"; Carbon Steel pipe conforming to ASTM A53, Type "E" or "S", Grade "B".

Steel Fittings

Forged Steel conforming to ASTM A106.

Adapter Flanges

Class 150 - Carbon Steel conforming to ANSI B16.5
 Class 300 - Carbon Steel conforming to ANSI B16.5

Fitting Size

Nominal Size	O.D.
In./DN(mm)	In./mm
2	2.375
50	60.3
2½	2.875
65	73.0
3	3.500
80	88.9
3½	4.000
90	101.6
4	4.500
100	114.3
5	5.563
140	141.3
6	6.625
150	168.3
8	8.625
200	219.1

Note:

The Fitting Size Chart is used to determine the O.D. of the pipe that the fittings is to be used with. Gruvlok Fittings are identified by either the Nominal size in inches or the Pipe O.D. In./mm.

- Introduction
- Couplings
- Outlets
- Fittings
- Valves & Accessories
- High Pressure
- CTS Copper System
- D-Electric Nipples
- Plain-End Fittings**
- HDPE Couplings
- Socket-Fittings
- Stainless Steel Method
- Roll Groovers
- Installation & Assembly
- Special Coatings
- Design Services
- Technical Data
- Master Format 3 Part Specs.
- Pictorial Index

Swaged Nipples Fig. 7077P

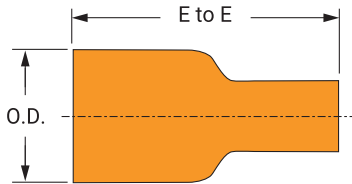

Nominal Size	End Center to End	Approx. Wt. Ea.	Nominal Size	End Center to End	Approx. Wt. Ea.
In./DN(mm)	In./mm	Lbs./kg	In./DN(mm)	In./mm	Lbs./kg
2½ x 2 65 x 50	7 178	3.0 1.4	6 x 2 150 x 50	12 305	17.0 7.7
3 x 2 80 x 50	8 203	4.5 2.0	6 x 2½ 150 x 65	12 305	17.0 7.7
3 x 2½ 80 x 65	8 203	4.5 2.0	6 x 3 150 x 80	12 305	17.0 7.7
4 x 2 100 x 50	9 229	7.5 3.4	6 x 4 150 x 100	12 305	17.0 7.7
4 x 2½ 100 x 65	9 229	7.5 3.4	6 x 5 150 x 125	12 305	17.0 7.7
4 x 3 100 x 80	9 229	7.5 3.4	8 x 3 200 x 80	13 330	29.0 13.2
5 x 2 125 x 50	11 279	11.5 5.2	8 x 4 200 x 100	13 330	29.0 13.2
5 x 3 125 x 80	11 279	11.5 5.2	8 x 5 200 x 125	13 330	29.0 13.2
5 x 4 125 x 100	11 279	11.5 5.2	8 x 6 200 x 150	13 330	29.0 13.2

HDPE Coupling
Fig. 7305



The Gruvlok Figure 7305 HDPE Coupling is a cost effective, easy to assemble, mechanical joint for HDPE pipe conforming to ASTM F714, D2447, D3000, or D3035 with wall thicknesses ranging from SDR 32.5 to SDR 7.3. The Gruvlok coupling method also eliminates the need for costly fusion equipment.

Each coupling uses four bolts to drive sharply machined teeth into the outside of the HDPE pipe. When the teeth effectively grip into the pipe, it provides a secure and rigid mechanical connection with pressure capabilities exceeding that of the HDPE pipe itself. The banks of teeth are positioned away from the gasket to enhance the gasket's sealing ability throughout the operating temperature range.

The Figure 7305 HDPE coupling also provides a low profile contoured housing with ramps along the outside diameter. This allows the coupling to slide over most obstacles when long lengths of the pipeline are relocated.

WARNING:

1. Gruvlok products for HDPE pipe must be installed using Gruvlok Xtreme Temperature Lubricant.
2. The listed gasket temperature rating may exceed the manufacturer's temperature rating for HDPE pipe. Consult with the HDPE pipe manufacturer for appropriate service temperatures before use.
3. The Figure 7305 HDPE Coupling is intended for use on HDPE Pipe only. Use of other plastic pipe materials is prohibited.

Material Specifications

Housing

Ductile Iron conforming to ASTM A 536, Grade 65-45-12

Coating

Rust inhibiting paint
Color: Orange

Other Colors Available
(IE: RAL3000 and RAL9000)

For other Coating requirements contact an ASC Engineered Solutions™ Representative.

Hardware

Bolts: SAE J429, Grade 5, Zinc Electroplated
Heavy Hex Nuts: ASTM A563, Grade A, Zinc Electroplated

Washers: Zinc Coated, Hardened Steel Washers per ASTM F436

Gaskets

Properties in accordance with ASTM D 2000

Grade E EPDM (Green color code)

Service Temperature Range: -30°F to 230°F (-34°C to 110°C).

Recommended for water service, dilute acids, alkaline solutions, oil free air and many chemical services.

NOT FOR USE IN PETROLEUM APPLICATIONS.

Grade T Nitrile (Orange color code)

Service Temperature Range: -20°F to 180°F (-29°C to 82°C).

Recommended for petroleum applications, air with oil vapor, vegetable and mineral oils.

NOT FOR USE WITH HOT WATER OR HOT AIR.

For specific chemical applications, reference the Gruvlok Gasket Recommendations section of the Gruvlok catalog.

- Introduction
- Couplings
- Outlets
- Fittings
- Valves & Accessories
- High Pressure
- CTS Copper System
- DI-Electric Nipples
- Plain-End Fittings
- HDPE Couplings
- Socket-Fittings
- Stainless Steel Method
- Roll Groovers
- Installation & Assembly
- Special Coatings
- Design Services
- Technical Data
- Master Format 3 Part Specs.
- Pictorial Index

HDPE Coupling Fig. 7305

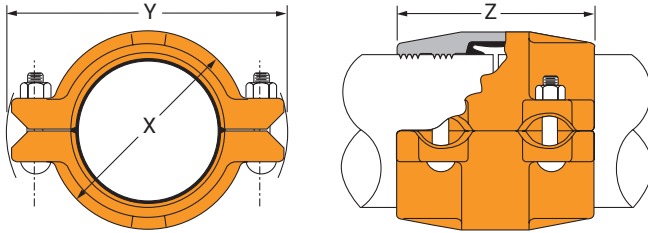

Nominal Size	Pipe O.D.	Coupling Dimensions			Coupling Bolts		Approx. Wt. Ea.
		X	Y	Z	Qty.	Size	
In./DN(mm)	In./DN(mm)	In./DN(mm)	In./DN(mm)	In./DN(mm)		In.	Lbs./Kg
2 50	2.375 60.3	3 ³ / ₈ 86	5 ¹ / ₂ 140	4 ⁵ / ₈ 117	4	1/2 x 2 ³ / ₈	4.5 2.0
3 80	3.500 88.9	4 ⁵ / ₈ 117	6 ³ / ₄ 171	4 ⁵ / ₈ 117	4	1/2 x 3	8.5 3.9
4 100	4.500 114.3	5 ³ / ₄ 146	8 203	5 ³ / ₄ 146	4	1/2 x 3	12.0 5.4
6 150	6.625 168.3	7 ⁷ / ₈ 200	11 279	5 ⁷ / ₈ 149	4	5/8 x 3 ¹ / ₂	18.0 8.2
8 200	8.625 219.1	10 ³ / ₈ 262	13 ¹ / ₄ 337	6 ¹ / ₈ 156	4	5/8 x 3 ³ / ₄	30.0 13.6
10 250	10.750 273.1	12 ⁵ / ₈ 319	15 ³ / ₄ 400	6 ¹ / ₂ 165	4	3/4 x 4 ³ / ₄	43.0 19.5
12 300	12.750 323.9	14 ¹ / ₂ 368	17 ⁷ / ₈ 454	7 ¹ / ₈ 181	4	3/4 x 4 ³ / ₄	58.0 26.3
14 350	14.000 355.6	16 ⁵ / ₈ 416	20 ³ / ₈ 518	10 ¹ / ₈ 256	4	1 x 5 ¹ / ₂	108.0 49.1
16 400	16.000 406.4	18 ¹ / ₂ 467	21 ³ / ₈ 541	10 ¹ / ₈ 256	4	1 x 4 ¹ / ₂	97.2 44.2
18 450	18.000 457.2	20 ³ / ₈ 515	23 ¹ / ₂ 595	10 ¹ / ₈ 256	4	1 x 4 ¹ / ₂	111.1 50.5

Note:

The pressure rating of the Figure 7305 HDPE Coupling is determined by the working pressure of the HDPE pipe installed. Consult with the HDPE pipe manufacturer for the appropriate working pressure before use. HDPE working pressures are determined by wall thickness, pipe composition, and applicable service temperature.

HDPE Coupling Fig. 7305

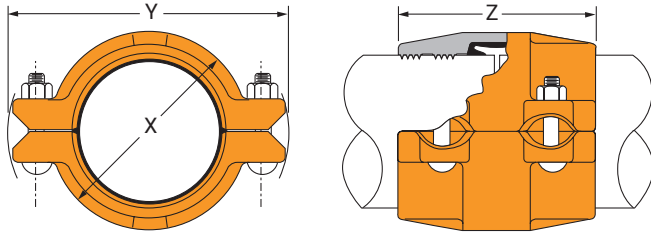

Nominal Size	O.D. Actual	O.D. Tolerance +/-	Out of Roundness Tolerance +/-	Pipe Wall Thickness						
				SDR 7.3	SDR 9	SDR 11	SDR 15.5	SDR 17	SDR 21	SDR 32.5
In./DN(mm)	In./mm	In./mm	In./mm	In./mm	In./mm	In./mm	In./mm	In./mm	In./mm	In./mm
2	2.375	0.006	0.035	0.325	0.264	0.216	0.153	0.140	0.113	—
50	60.3	0.15	0.89	8.3	6.7	5.5	3.9	3.6	2.9	—
3	3.500	0.016	0.040	0.479	0.389	0.318	0.226	0.206	0.167	0.108
80	88.9	0.41	1.02	12.2	9.9	8.1	5.7	5.2	4.2	2.7
4	4.500	0.020	0.040	0.616	0.500	0.409	0.290	0.265	0.214	0.138
100	114.3	0.51	1.02	15.6	12.7	10.4	7.4	6.7	5.4	3.5
6	6.625	0.030	0.050	0.908	0.736	0.602	0.427	0.327	0.265	0.204
150	168.3	0.76	1.27	23.1	18.7	15.3	10.8	8.3	6.7	5.2
8	8.625	0.039	0.075	1.182	0.958	0.784	0.556	0.507	0.340	0.265
200	219.1	0.99	1.91	30.0	24.3	19.9	14.1	12.9	8.6	6.7
10	10.750	0.048	0.075	1.473	1.194	0.977	0.694	0.632	0.512	0.331
250	273.1	1.22	1.91	37.4	30.3	24.8	17.6	16.1	13.0	8.4
12	12.750	0.057	0.075	1.747	1.417	1.159	0.823	0.750	0.607	0.392
300	323.9	1.45	1.91	44.4	36	29.4	20.9	19.1	15.4	10.0
14	14.000	0.063	0.075	1.918	1.556	1.273	0.903	0.824	0.667	0.431
350	355.6	1.60	1.91	48.7	39.5	32.3	22.9	20.9	16.9	10.9
16	16.000	0.072	0.075	2.192	1.778	1.455	1.032	0.941	0.762	0.492
400	406.4	1.83	1.91	55.7	45.2	37.0	26.2	23.9	19.4	12.5
18	18.000	0.081	0.075	2.466	2.000	1.636	1.161	1.059	0.857	0.554
450	457.2	2.06	1.91	62.6	50.8	41.6	29.5	26.9	21.8	14.1

Note:

HDPE Pipe Dimensions per ASTM F714, ASTM D2447, and ASTM D3035.

See Installation & Assembly directions in the Technical Data Section of the Gruvlok Catalog.

HDPE Transition Coupling Fig. 7307

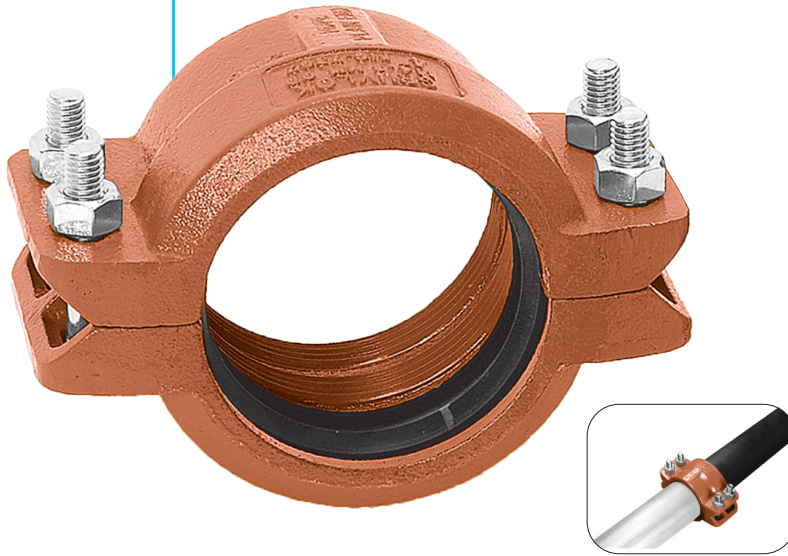

Material Specifications

Housing

Ductile Iron conforming to ASTM A 536, Grade 65-45-12

Coating

Rust inhibiting paint

Color: Orange

Other Colors Available

(IE: RAL3000 and RAL9000)

For other Coating requirements contact an ASC Engineered Solutions™ Representative.

Hardware

Bolts: SAE J429, Grade 5, Zinc Electroplated

Heavy Hex Nuts: ASTM A563, Grade A, Zinc Electroplated

Washers: Zinc Coated, Hardened Steel Washers per ASTM F436

Gaskets

Properties in accordance with ASTM D 2000

Grade E EPDM (Green color code)

Service Temperature Range: -30°F to 230°F (-34°C to 110°C).

Recommended for water service, dilute acids, alkaline solutions, oil free air and many chemical services.

NOT FOR USE IN PETROLEUM APPLICATIONS.

Grade T Nitrile (Orange color code)

Service Temperature Range: -20°F to 180°F (-29°C to 82°C).

Recommended for petroleum applications, air with oil vapor, vegetable and mineral oils.

NOT FOR USE WITH HOT WATER OR HOT AIR.

For specific chemical applications, reference the Gruvlok Gasket Recommendations section of the Gruvlok catalog.

The Gruvlok Figure 7307 HDPE Transition Coupling is a cost effective, easy to assemble, mechanical joint intended to connect HDPE pipe to Gruvlok standard weight roll or cut grooved steel pipe, lightweight roll grooved pipe, or Gruvlok grooved-end fittings and valves. The Figure 7307 is compatible with HDPE pipe conforming to ASTM F714, D2447, D3000, or D3035 having wall thicknesses ranging from SDR 32.5 to SDR 7.3 and any schedule steel pipe conforming to Gruvlok's standard pipe specifications.

Each coupling uses four bolts to drive sharply machined teeth into the outside of the HDPE pipe and engages a keyed section into the grooved steel pipe or fitting. When the teeth effectively grip into the pipe, it provides a secure and rigid mechanical connection with pressure capabilities exceeding that of the HDPE pipe itself without the need for costly fusion equipment.

The banks of teeth are positioned away from the gasket to enhance the coupling's sealing ability throughout the operating temperature range. As a result, the temperature and pressure capabilities of the Figure 7307 Transition Coupling exceed the highest temperature and pressure ratings of the HDPE pipe.

The Figure 7307 HDPE Transition Coupling also features a low-profile contoured housing with ramps along the outside diameter. This allows the coupling to slide over most obstacles when long lengths of the pipeline are relocated.

WARNING:

1. Gruvlok products for HDPE pipe must be installed using Gruvlok Xtreme Temperature Lubricant.
2. The listed gasket temperature rating may exceed the manufacturer's temperature rating for HDPE pipe. Consult with the HDPE pipe manufacturer for appropriate service temperatures before use.
3. The Figure 7307 HDPE Coupling is intended for use on HDPE Pipe only. Use of other plastic pipe materials is prohibited.

HDPE Transition Coupling Fig. 7307

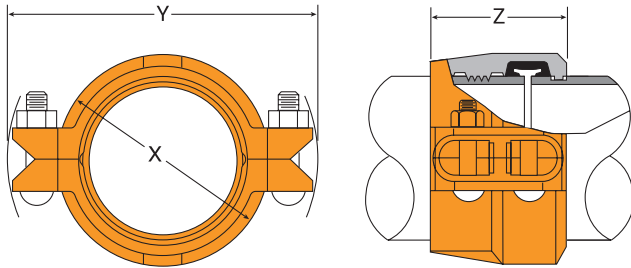

Nominal Size	Pipe O.D.	Coupling Dimensions			Coupling Bolts		Approx. Wt. Ea.
		X	Y	Z	Qty.	Size	
In./DN(mm)	In./DN(mm)	In./DN(mm)	In./DN(mm)	In./DN(mm)		In.	Lbs./Kg
2 50	2.375 60.3	3½ 89	5⅞ 149	3⅞ 79	4	½ x 2⅜	4.5 2.0
3 80	3.500 88.9	4⅝ 117	7 178	3⅞ 79	4	½ x 3	8.5 3.9
4 100	4.500 114.3	5⅞ 149	8¼ 210	3¾ 95	4	½ x 3	12 5.4
6 150	6.625 168.3	8 203	11⅞ 283	3¾ 95	4	⅝ x 3½	18 8.2
8 200	8.625 219.1	10⅝ 262	13½ 343	4¼ 108	4	⅝ x 3¾	30 13.6
10 250	10.750 273.1	12¾ 324	16¾ 425	5 127	4	¾ x 4¾	43 19.5
12 300	12.750 323.9	14¾ 375	19 483	5 127	4	7⁄8 x 5	58 26.3

Note:

The pressure rating of the Figure 7307 HDPE Transition Coupling is determined by the working pressure of the HDPE pipe installed. Consult with the HDPE pipe manufacturer for the appropriate working pressure before use. HDPE working pressures are determined by wall thickness, pipe composition, and applicable service temperature.

- Introduction
- Couplings
- Outlets
- Fittings
- Valves & Accessories
- High Pressure
- CTS Copper System
- DI-Electric Nipples
- Plan-End Fittings
- HDPE Couplings**
- Socket-It® Fittings
- Stainless Steel Method
- Roll Groovers
- Installation & Assembly
- Special Coatings
- Design Services
- Technical Data
- Master Format 3 Part Specs.
- Pictorial Index

HDPE Flange Adapter Fig. 7312

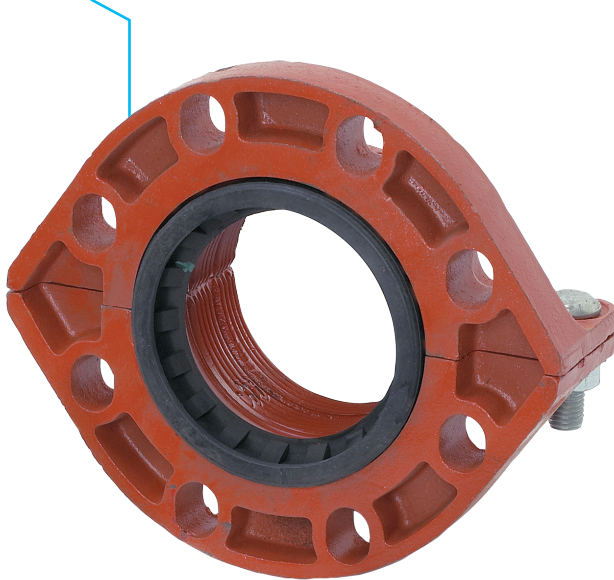

The Gruvlok Figure 7312 HDPE Flange Adapter is a cost effective, easy to assemble, mechanical joint intended to connect HDPE pipe to any ASME/ANSI Class 125 or Class 150 flanged piping components without the need for costly fusion equipment. The Figure 7312 is compatible with HDPE pipe conforming to ASTM F714, D2447, D3000, or D3035 having wall thicknesses ranging from SDR 32.5 to SDR 7.3.

Each coupling uses two bolts to drive sharply machined teeth into the outside of the HDPE pipe. When the teeth effectively grip into the pipe, it provides a secure and rigid mechanical connection with pressure capabilities exceeding that of the HDPE pipe itself. The banks of teeth are positioned away from the gasket to enhance the coupling's sealing ability throughout the operating temperature range. As a result, the temperature and pressure capabilities of the Figure 7307 Transition Coupling exceed the highest temperature and pressure ratings of the HDPE pipe.

WARNING:

1. Gruvlok products for HDPE pipe must be installed using Gruvlok Xtreme Temperature Lubricant.
2. The listed gasket temperature rating may exceed the manufacturer's temperature rating for HDPE pipe. Consult with the HDPE pipe manufacturer for appropriate service temperatures before use.
3. The Figure 7312 HDPE Coupling is intended for use on HDPE Pipe only. Use of other plastic pipe materials is prohibited.

Material Specifications

Housing

Ductile Iron conforming to ASTM A 536, Grade 65-45-12

Coating

Rust inhibiting paint
Color: Orange

Other Colors Available
(IE: RAL3000 and RAL9000)

For other Coating requirements contact an ASC Engineered Solutions™ Representative.

Hardware

Bolts: SAE J429, Grade 5, Zinc Electroplated
Heavy Hex Nuts: ASTM A563, Grade A, Zinc Electroplated

Washers: Zinc Coated, Hardened Steel Washers per ASTM F436

Gaskets

Properties in accordance with ASTM D2000

Grade E EPDM (Green color code)

Service Temperature Range: -30°F to 230°F (-34°C to 110°C).

Recommended for water service, dilute acids, alkaline solutions, oil free air and many chemical services.

NOT FOR USE IN PETROLEUM APPLICATIONS.

Grade T Nitrile (Orange color code)

Service Temperature Range: -20°F to 180°F (-29°C to 82°C).

Recommended for petroleum applications, air with oil vapor, vegetable and mineral oils.

NOT FOR USE WITH HOT WATER OR HOT AIR.

For specific chemical applications, reference the Gruvlok Gasket Recommendations section of the Gruvlok catalog.

HDPE Flange Adapter Fig. 7312

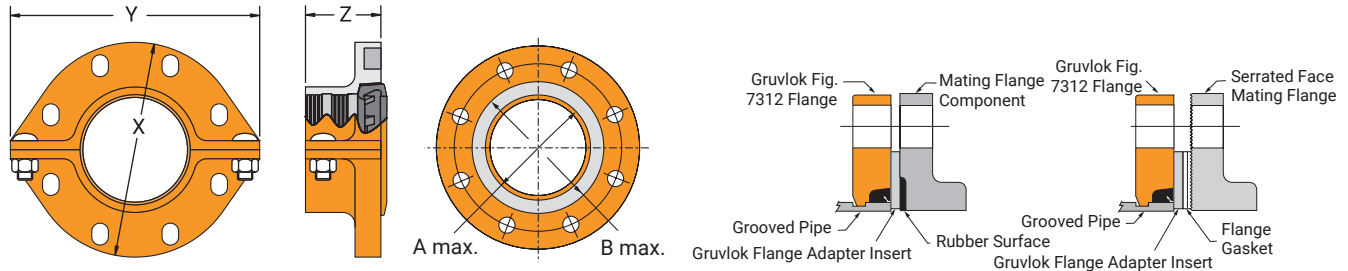

Fig. 7312 HDPE Flange Adapter

Nominal Size	Pipe O.D.	Flange Dimensions			Sealing Surface		Latch Bolt		Mating Flange Bolts		Approx. Wt. Ea.
		X	Y	Z	A Max.	B Min.	Qty.	Size	Qty.	Size	
In./DN(mm)	In./DN(mm)	In./mm	In./mm	In./mm	In./mm	In./mm		In./mm		In./mm	Lbs./kg
4 100	4.500 114.3	8 ⁷ / ₈ 225	10 ¹ / ₄ 260	3 76	4 ⁵ / ₈ 117	5 ³ / ₈ 137	2	5/8 X 2	8	5/8 X 3	12 5.4
6 150	6.625 168.3	11 ¹ / ₈ 283	12 ¹ / ₄ 311	3 ¹ / ₂ 89	6 ³ / ₄ 171	7 ⁵ / ₈ 194	2	3/4 X 3 1/2	8	3/4 X 3 1/2	18 8.2
8 200	8.625 219.1	13 ¹ / ₂ 343	14 ³ / ₄ 375	3 ¹ / ₂ 89	8 ³ / ₄ 222	9 ⁷ / ₈ 251	2	3/4 X 3 1/2	8	3/4 X 3 1/2	30 13.6

Note:

- A. The sealing surfaces A Max. to B Min. of the mating flange must be free from gouges, undulations and deformities of any type to ensure proper sealing of gasket.
- B. Gruvlok Flanges are to be assembled on butterfly valves so as not to interfere with actuator or handle operation.
- C. Do not use Gruvlok Flanges within 90 degrees of one another on standard fittings because the outside dimensions may cause interference.
- D. Gruvlok Flanges should not be used as anchor points for tierods across nonrestrained joints.
- E. Fig. 7312 Gruvlok Flange sealing gaskets require a hard flat surface for adequate sealing. The use of a Gruvlok Flange Adapter Insert is required for applications against rubber faced valves or other equipment. The Gruvlok Flange Adapter Insert is installed between the Gruvlok Flange sealing gasket and the mating flange or surface to provide a good sealing surface area.
- F. Gruvlok Flanges are not recommended for use against formed rubber flanges.
- G. The pressure rating of the Figure 7307 HDPE Transition Coupling is determined by the working pressure of the HDPE pipe installed. Consult with the HDPE pipe manufacturer for the appropriate working pressure before use. HDPE working pressures are determined by wall thickness, pipe composition, and applicable service temperature.

HDPE Flange Adapter Fig. 7312

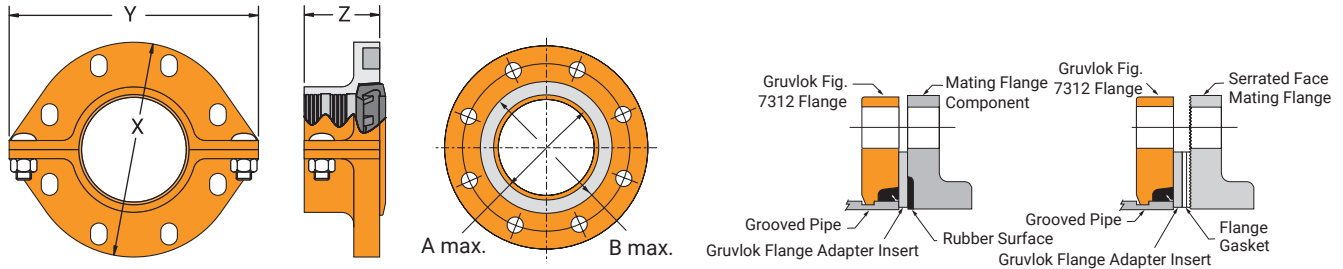

HDPE Pipe Dimensional Specifications

Nominal Size	Pipe O.D.	O.D. Tolerance +/-	Out of Roundness Tolerance +/-	Pipe Wall Thickness						
				SDR 7.3	SDR 9	SDR 11	SDR 15.5	SDR 17	SDR 21	SDR 32.5
In./DN(mm)	In./mm	In./mm	In./mm	In./mm	In./mm	In./mm	In./mm	In./mm	In./mm	In./mm
4	4.500	0.020	0.040	0.616	0.500	0.409	0.290	0.265	0.214	0.138
100	114.3	0.51	1.02	15.6	12.7	10.4	7.4	6.7	5.4	3.5
6	6.625	0.030	0.050	0.908	0.736	0.602	0.427	0.327	0.265	0.204
150	168.3	0.76	1.27	23.1	18.7	15.3	10.8	8.3	6.7	5.2
8	8.625	0.039	0.075	1.182	0.958	0.784	0.556	0.507	0.340	0.265
200	219.1	0.99	1.91	30.0	24.3	19.9	14.1	12.9	8.6	6.7

Note:

HDPE Pipe Dimensions per ASTM F714, ASTM D2447, and ASTM D3035.

See Installation & Assembly directions in the Technical Data Section of the Gruvlok Catalog.

Applications Which Require a Gruvlok Flange Adapter Insert:

1. When mating to a wafer valve (lug valve), if the valve is rubber faced in the area designated by the sealing surface dimensions (A Max. to B Min.), place the Gruvlok Flange Adapter Insert between the valve and the Gruvlok Flange.
2. When mating to a rubber-faced metal flange, the Gruvlok Flange Adapter Insert is placed between the Gruvlok Flange and the rubber-faced flange.
3. When mating to a serrated flange surface, a standard fullfaced flange gasket is installed against the serrated flange face, and the Gruvlok Flange Adapter Insert is placed between the Gruvlok Flange and the standard flange gasket.
4. When mating to valves or other component equipment where the flange face has an insert, use procedure described in note 3.

Sock-it Piping Method Fittings Fig. 7100



For Listings/Approval Details and Limitations, visit our website at www.asc-es.com or contact an ASC Engineered Solutions™ Sales Representative.

The Gruvlok Sock-it Piping Method provides a quick, secure and reliable method of joining plain-end steel pipe. Several Sock-it configurations are available: tees with NPT outlets, reducing run tees with NPT outlets, straight couplings, 90 elbows, straight tees and reducing elbows. Pressure energized elastomeric gaskets provide the Sock-it with a leak tight seal. Specially designed lock bolts secure the pipe in the Sock-it Fitting, providing a fast, dependable way of joining small diameter plain-end pipe.

Working pressure ratings shown are for reference only and are based on schedule 40 pipe. For the latest UL/ULC Listed and FM approved pressure ratings versus pipe schedule see www.asc-es.com or contact your local ASC Engineered Solutions™ Sales Representative.

For Listings/Approval Details and Limitations, visit our website at www.asc-es.com or contact an ASC Engineered Solutions Sales Representative.

NOTE: All Sock-it fittings are UL/ULC Listed and FM Approved for 175 psi working pressure when used to join XL Pipe and Dyna-Flow Pipe.

Material Specifications

Housing

Cast iron ASTM A 126 CLASS A

Bolts

Case hardened carbon steel, dichromate finish

Gaskets

EPDM, as specified in accordance with ASTM D2000

Fitting Size

Nominal Size	O.D.
In./DN(mm)	In./mm
1/2	0.840
15	21.3
3/4	1.050
20	26.7
1	1.315
25	33.7
1 1/4	1.660
32	42.4
1 1/2	1.900
40	48.3
2	2.375
50	60.3
2 1/2	2.875
65	73.0

Note:

The Fitting Size Chart is used to determine the O.D. of the pipe that the fittings is to be used with. Gruvlok Fittings are identified by either the Nominal size in inches or the Pipe O.D. in mm.

90° Elbow (Sock-it x Sock-it) Fig. 7100

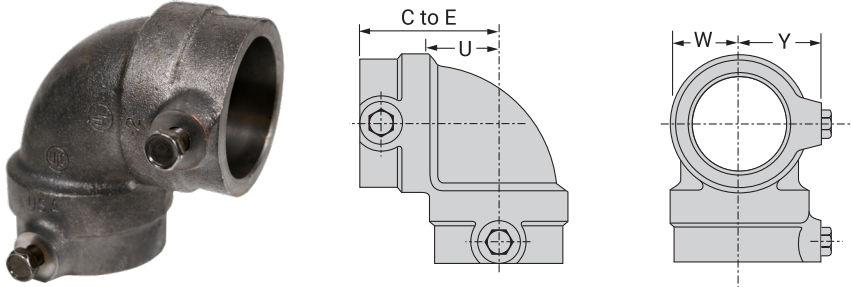

Nominal Size	O.D.	Max. Working Pressure		Dimensions				Approx. Wt. Ea.
		UL/ULC Listed	FM Approved	Center to End	U*	W	Y	
In./DN(mm)	In./mm	PSI/bar	PSI/bar	In./mm	In./mm	In./mm	In./mm	Lbs./kg
1	1.315	300	300	2 ⁵ / ₁₆	7/8	1 1/16	1 ³ / ₄	1.9
25	33.7	20.7	20.7	59	22	27	44	0.9
1 ¹ / ₄	1.660	300	300	2 ⁷ / ₁₆	1	1 ¹ / ₄	1 ¹³ / ₁₆	2.3
32	42.4	20.7	20.7	62	25	32	46	1.0
1 ¹ / ₂	1.900	300	300	2 ⁵ / ₈	1 ¹ / ₈	1 ³ / ₈	1 ¹⁵ / ₁₆	2.7
40	48.3	20.7	20.7	67	29	35	49	1.2
2	2.375	175	250	3 ¹ / ₄	1 ⁹ / ₁₆	1 ⁵ / ₈	2 ³ / ₁₆	4.0
50	60.3	12.1	17.2	83	40	41	56	1.8

Note:

* "U" - Run take-out dimension.

Sock-it Piping Method Fittings Fig. 7101



For Listings/Approval Details and Limitations, visit our website at www.asc-es.com or contact an ASC Engineered Solutions™ Sales Representative.

The Gruvlok Sock-it Piping Method provides a quick, secure and reliable method of joining plain-end steel pipe. Several Sock-it configurations are available: tees with NPT outlets, reducing run tees with NPT outlets, straight couplings, 90 elbows, straight tees and reducing elbows. Pressure energized elastomeric gaskets provide the Sock-it with a leak tight seal. Specially designed lock bolts secure the pipe in the Sock-it Fitting, providing a fast, dependable way of joining small diameter plain-end pipe.

Working pressure ratings shown are for reference only and are based on schedule 40 pipe. For the latest UL/ULC Listed and FM approved pressure ratings versus pipe schedule see www.asc-es.com or contact your local ASC Engineered Solutions™ Sales Representative.

For Listings/Approval Details and Limitations, visit our website at www.asc-es.com or contact an ASC Engineered Solutions Sales Representative.

NOTE: All Sock-it fittings are UL/ULC Listed and FM Approved for 175 psi working pressure when used to join XL Pipe and Dyna-Flow Pipe.

Material Specifications

Housing

Cast iron ASTM A 126 CLASS A

Bolts

Case hardened carbon steel, dichromate finish

Gaskets

EPDM, as specified in accordance with ASTM D2000

Fitting Size

Nominal Size	O.D.
In./DN(mm)	In./mm
1/2	0.840
15	21.3
3/4	1.050
20	26.7
1	1.315
25	33.7
1 1/4	1.660
32	42.4
1 1/2	1.900
40	48.3
2	2.375
50	60.3
2 1/2	2.875
65	73.0

Note:

The Fitting Size Chart is used to determine the O.D. of the pipe that the fittings is to be used with. Gruvlok Fittings are identified by either the Nominal size in inches or the Pipe O.D. in mm.

- Introduction
- Couplings
- Outlets
- Fittings
- Valves & Accessories
- High Pressure
- CTS Copper System
- DI-Electric Nipples
- Plan-End Fittings
- HDPE Couplings
- Sock-It® Fittings**
- Stainless Steel Method
- Roll Groovers
- Installation & Assembly
- Special Coatings
- Design Services
- Technical Data
- Master Format 3 Part Specs.
- Pictorial Index

90° Reducing Elbow (Sock-it x NPT) Fig. 7101

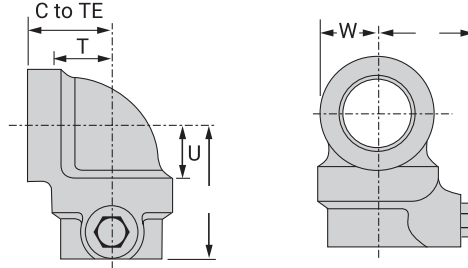

Nominal Size	Max. Working Pressure		Dimensions						Approx. Wt. Ea.
	UL/ULC Listed	FM Approved	Center to TE	Center to SE	U*	T**	W	Y	
In./DN(mm)	PSI/bar	PSI/bar	In./mm	In./mm	In./mm	In./mm	In./mm	In./mm	Lbs./kg
1 x 1/2	300	300	1 7/16	2 5/16	7/8	1	1 1/16	1 11/16	1.7
25 x 15	20.7	20.7	37	59	22	25	27	43	0.8
1 x 3/4	300	300	1 7/16	2 5/16	7/8	7/8	1 1/16	1 11/16	1.6
25 x 20	20.7	20.7	37	59	22	22	27	43	0.7
1 x 1	300	300	1 7/16	2 5/16	7/8	7/8	1 1/16	1 11/16	1.5
25 x 25	20.7	20.7	37	59	22	22	27	43	0.7
1 1/4 x 1/2	300	300	1 9/16	2 1/2	1 1/16	1 1/8	1 1/4	1 13/16	2.2
32 x 15	20.7	20.7	40	64	17	29	32	46	1.0
1 1/4 x 3/4	300	300	1 9/16	2 1/2	1 1/16	1	1 1/4	1 13/16	2.1
32 x 20	20.7	20.7	40	64	17	25	32	46	1.0
1 1/4 x 1	300	300	1 9/16	2 1/2	1 1/16	1	1 1/4	1 13/16	2
32 x 25	20.7	20.7	40	64	17	25	32	46	0.9
1 1/2 x 1/2	300	300	1 11/16	2 1/2	1	1 1/4	1 3/8	1 15/16	2.5
40 x 15	20.7	20.7	43	64	25	32	35	49	1.1
1 1/2 x 3/4	300	300	1 11/16	2 1/2	1	1 1/8	1 3/8	1 15/16	2.4
40 x 20	20.7	20.7	43	64	25	29	35	49	1.1
1 1/2 x 1	300	300	1 11/16	2 1/2	1	1 1/8	1 3/8	1 15/16	2.3
40 x 25	20.7	20.7	43	64	25	29	35	49	1.0

Note:

C to SE - Center to Sock-it End
C to TE - Center to Thread End

* "U" - Take-out dimension, Sock-it End

** "T" - Take-out dimension, Thread End

Sock-it Piping Method Fittings Fig. 7103



For Listings/Approval Details and Limitations, visit our website at www.asc-es.com or contact an ASC Engineered Solutions™ Sales Representative.

The Gruvlok Sock-it Piping Method provides a quick, secure and reliable method of joining plain-end steel pipe. Several Sock-it configurations are available: tees with NPT outlets, reducing run tees with NPT outlets, straight couplings, 90 elbows, straight tees and reducing elbows. Pressure energized elastomeric gaskets provide the Sock-it with a leak tight seal. Specially designed lock bolts secure the pipe in the Sock-it Fitting, providing a fast, dependable way of joining small diameter plain-end pipe.

Working pressure ratings shown are for reference only and are based on schedule 40 pipe. For the latest UL/ULC Listed and FM approved pressure ratings versus pipe schedule see www.asc-es.com or contact your local ASC Engineered Solutions™ Sales Representative.

For Listings/Approval Details and Limitations, visit our website at www.asc-es.com or contact an ASC Engineered Solutions Sales Representative.

NOTE: All Sock-it fittings are UL/ULC Listed and FM Approved for 175 psi working pressure when used to join XL Pipe and Dyna-Flow Pipe.

Material Specifications

Housing

Cast iron ASTM A 126 CLASS A

Bolts

Case hardened carbon steel, dichromate finish

Gaskets

EPDM, as specified in accordance with ASTM D2000

Fitting Size

Nominal Size	O.D.
In./DN(mm)	In./mm
1/2	0.840
15	21.3
3/4	1.050
20	26.7
1	1.315
25	33.7
1 1/4	1.660
32	42.4
1 1/2	1.900
40	48.3
2	2.375
50	60.3
2 1/2	2.875
65	73.0

Note:

The Fitting Size Chart is used to determine the O.D. of the pipe that the fittings is to be used with. Gruvlok Fittings are identified by either the Nominal size in inches or the Pipe O.D. in mm.

Straight Tee (Sock-it x Sock-it x Sock-it) Fig. 7103

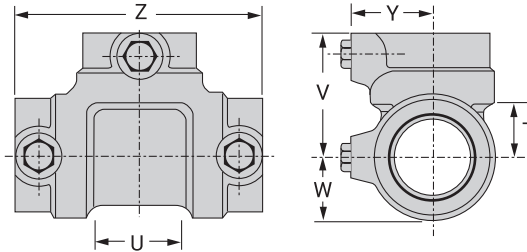

Nominal Size	O.D.	Max. Working Pressure		Dimensions							Approx. Wt. Ea.
		UL/ULC Listed	FM Approved	T**	U*	V	W	Y	Z		
In./DN(mm)	In./mm	PSI/bar	PSI/bar	In./mm	In./mm	In./mm	In./mm	In./mm	In./mm	Lbs./kg	
1	1.315	300	300	1 ³ / ₁₆	1 ⁵ / ₈	2 ¹ / ₄	1 ¹ / ₁₆	1 ¹¹ / ₁₆	4 ¹ / ₂	2.3	
25	33.7	20.7	20.7	21	41	57	27	43	114	1	
1 ¹ / ₄	1.660	175	300	1	2	2 ⁷ / ₁₆	1 ¹ / ₄	1 ⁹ / ₁₆	4 ⁷ / ₈	2.9	
32	42.4	12.1	20.7	25	51	62	32	46	124	1.3	
1 ¹ / ₂	1.900	175	300	1 ¹ / ₁₆	2 ¹ / ₈	2 ⁹ / ₁₆	1 ³ / ₈	1 ¹⁵ / ₁₆	5 ¹ / ₈	3.4	
40	48.3	12.1	20.7	17	54	65	35	49	130	1.5	
2	2.375	175	250	1 ⁵ / ₁₆	2 ⁵ / ₈	3	1 ¹¹ / ₁₆	2 ³ / ₁₆	6	5.6	
50	60.3	12.1	17.2	23	67	76	43	56	152	2.5	

Note:

* "U" – Run take-out dimension.

** "T" – Outlet take-out dimension.

Sock-it Piping Method Fittings Fig. 7107



For Listings/Approval Details and Limitations, visit our website at www.asc-es.com or contact an ASC Engineered Solutions™ Sales Representative.

The Gruvlok Sock-it Piping Method provides a quick, secure and reliable method of joining plain-end steel pipe. Several Sock-it configurations are available: tees with NPT outlets, reducing run tees with NPT outlets, straight couplings, 90 elbows, straight tees and reducing elbows. Pressure energized elastomeric gaskets provide the Sock-it with a leak tight seal. Specially designed lock bolts secure the pipe in the Sock-it Fitting, providing a fast, dependable way of joining small diameter plain-end pipe.

Working pressure ratings shown are for reference only and are based on schedule 40 pipe. For the latest UL/ULC Listed and FM approved pressure ratings versus pipe schedule see www.asc-es.com or contact your local ASC Engineered Solutions™ Sales Representative.

For Listings/Approval Details and Limitations, visit our website at www.asc-es.com or contact an ASC Engineered Solutions Sales Representative.

NOTE: All Sock-it fittings are UL/ULC Listed and FM Approved for 175 psi working pressure when used to join XL Pipe and Dyna-Flow Pipe.

Material Specifications

Housing

Cast iron ASTM A 126 CLASS A

Bolts

Case hardened carbon steel, dichromate finish

Gaskets

EPDM, as specified in accordance with ASTM D2000

Fitting Size

Nominal Size	O.D.
In./DN(mm)	In./mm
1/2	0.840
15	21.3
3/4	1.050
20	26.7
1	1.315
25	33.7
1 1/4	1.660
32	42.4
1 1/2	1.900
40	48.3
2	2.375
50	60.3
2 1/2	2.875
65	73.0

Note:

The Fitting Size Chart is used to determine the O.D. of the pipe that the fittings is to be used with. Gruvlok Fittings are identified by either the Nominal size in inches or the Pipe O.D. in mm.

Coupling (Sock-it x Sock-it) Fig. 7107

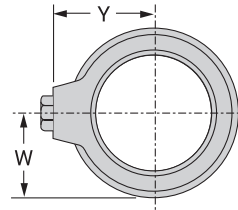
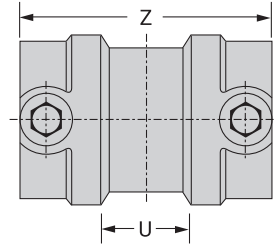

Nominal Size	O.D.	Max. Working Pressure		U*	Dimensions			Approx. Wt. Ea.
		UL/ULC Listed	FM Approved		W	Y	Z	
In./DN(mm)	In./mm	PSI/bar	PSI/bar	In./mm	In./mm	In./mm	In./mm	Lbs./kg
1	1.315	300	300	1/4	1 1/16	1 11/16	3 1/8	1.7
25	33.7	20.7	20.7	6	27	43	79	0.8
1 1/4	1.660	300	300	1/4	1 1/4	1 13/16	3 1/8	1.9
32	42.4	20.7	20.7	6	32	46	79	0.9
1 1/2	1.900	300	300	1/4	1 3/8	1 15/16	3 1/4	2.1
40	48.3	20.7	20.7	6	35	49	83	1
2	2.375	175	250	1/4	1 5/8	2 3/16	3 5/8	2.9
50	60.3	12.1	17.2	6	41	56	92	1.3

Note:

* "U" - Run take-out dimension.

Sock-it Piping Method Fittings Fig. 7105



For Listings/Approval Details and Limitations, visit our website at www.asc-es.com or contact an ASC Engineered Solutions™ Sales Representative.

The Gruvlok Sock-it Piping Method provides a quick, secure and reliable method of joining plain-end steel pipe. Several Sock-it configurations are available: tees with NPT outlets, reducing run tees with NPT outlets, straight couplings, 90 elbows, straight tees and reducing elbows. Pressure energized elastomeric gaskets provide the Sock-it with a leak tight seal. Specially designed lock bolts secure the pipe in the Sock-it Fitting, providing a fast, dependable way of joining small diameter plain-end pipe.

Working pressure ratings shown are for reference only and are based on schedule 40 pipe. For the latest UL/ULC Listed and FM approved pressure ratings versus pipe schedule see www.asc-es.com or contact your local ASC Engineered Solutions™ Sales Representative.

For Listings/Approval Details and Limitations, visit our website at www.asc-es.com or contact an ASC Engineered Solutions Sales Representative.

NOTE: All Sock-it fittings are UL/ULC Listed and FM Approved for 175 psi working pressure when used to join XL Pipe and Dyna-Flow Pipe.

Material Specifications

Housing

Cast iron ASTM A 126 CLASS A

Bolts

Case hardened carbon steel, dichromate finish

Gaskets

EPDM, as specified in accordance with ASTM D2000

Fitting Size

Nominal Size	O.D.
In./DN(mm)	In./mm
1/2	0.840
15	21.3
3/4	1.050
20	26.7
1	1.315
25	33.7
1 1/4	1.660
32	42.4
1 1/2	1.900
40	48.3
2	2.375
50	60.3
2 1/2	2.875
65	73.0

Note:

The Fitting Size Chart is used to determine the O.D. of the pipe that the fittings is to be used with. Gruvlok Fittings are identified by either the Nominal size in inches or the Pipe O.D. in mm.

Reducing Outlet Tee (Sock-it x Sock-it x NPT) Fig. 7105

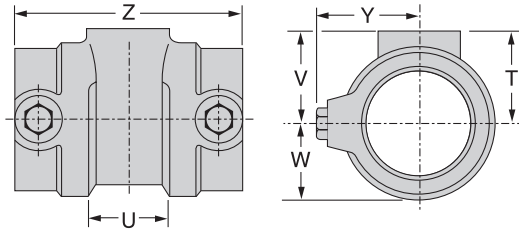

Nominal Size	Max. Working Pressure		Dimensions						Approx. Wt. Ea.
	UL/ULC Listed	FM Approved	T**	U*	V	W	Y	Z	
In./DN(mm)	PSI/bar	PSI/bar	In./mm	In./mm	In./mm	In./mm	In./mm	In./mm	Lbs./kg
1 x 1 x 1/2 25 x 25 x 15	300 20.7	300 20.7	1 25	1 3/8 35	1 1/16 37	1 1/16 27	1 11/16 43	4 1/4 108	2.0 0.9
1 x 1 x 3/4 25 x 25 x 20	300 20.7	300 20.7	7/8 22	1 3/8 35	1 1/16 37	1 1/16 27	1 11/16 43	4 1/4 108	1.9 0.9
1 x 1 x 1 25 x 25 x 25	300 20.7	300 20.7	7/8 22	1 3/8 35	1 1/16 37	1 1/16 27	1 11/16 43	4 1/4 108	1.9 0.9
1 1/4 x 1 1/4 x 1/2 32 x 32 x 15	300 20.7	300 20.7	1 1/8 29	1 3/8 35	1 5/8 41	1 1/4 32	1 13/16 46	4 1/4 108	2.2 1.0
1 1/4 x 1 1/4 x 3/4 32 x 32 x 20	300 20.7	300 20.7	1 25	1 3/8 35	1 5/8 41	1 1/4 32	1 13/16 46	4 1/4 108	2.2 1.0
1 1/4 x 1 1/4 x 1 32 x 32 x 25	300 20.7	300 20.7	1 25	1 3/8 35	1 5/8 41	1 1/4 32	1 13/16 46	4 1/4 108	2.0 0.9
1 1/2 x 1 1/2 x 1/2 40 x 40 x 15	300 20.7	300 20.7	1 1/4 32	1 3/8 35	1 3/4 44	1 3/8 35	1 15/16 49	4 3/8 111	2.7 1.2
1 1/2 x 1 1/2 x 3/4 40 x 40 x 20	300 20.7	300 20.7	1 1/8 29	1 3/8 35	1 3/4 44	1 3/8 35	1 15/16 49	4 3/8 111	2.6 1.2
1 1/2 x 1 1/2 x 1 40 x 40 x 25	300 20.7	300 20.7	1 1/8 29	1 3/8 35	1 3/4 44	1 3/8 35	1 15/16 49	4 3/8 111	2.5 1.1
2 x 2 x 1/2 50 x 50 x 15	175 12.1	250 17.2	1 1/2 38	1 3/8 35	1 15/16 49	1 5/8 41	2 3/16 56	4 3/4 121	3.5 1.6
2 x 2 x 3/4 50 x 50 x 20	175 12.1	250 17.2	1 3/8 35	1 3/8 35	1 15/16 49	1 5/8 41	2 3/16 56	4 3/4 121	3.4 1.5
2 x 2 x 1 50 x 50 x 25	175 12.1	250 17.2	1 3/8 35	1 3/8 35	1 15/16 49	1 5/8 41	2 3/16 56	4 3/4 121	3.3 1.5
2 1/2 x 2 1/2 x 3/4 65 x 65 x 20	175 12.1	175 12.1	1 1/2 38	1 3/8 35	2 1/8 54	1 15/16 49	2 7/16 62	4 3/4 121	5.2 2.4
2 1/2 x 2 1/2 x 1 65 x 65 x 25	175 12.1	175 12.1	1 1/2 38	1 3/8 35	2 1/8 54	1 15/16 49	2 7/16 62	4 3/4 121	5.2 2.4

Note:

- * "U" - Run take-out dimension.
- ** "T" - Outlet take-out dimension.

Sock-it Piping Method Fittings Fig. 7106



The Gruvlok Sock-it Piping Method provides a quick, secure and reliable method of joining plain-end steel pipe. Several Sock-it configurations are available: tees with NPT outlets, reducing run tees with NPT outlets, straight couplings, 90 elbows, straight tees and reducing elbows. Pressure energized elastomeric gaskets provide the Sock-it with a leak tight seal. Specially designed lock bolts secure the pipe in the Sock-it Fitting, providing a fast, dependable way of joining small diameter plain-end pipe.

Working pressure ratings shown are for reference only and are based on schedule 40 pipe. For the latest UL/ULC Listed and FM approved pressure ratings versus pipe schedule see www.asc-es.com or contact your local ASC Engineered Solutions™ Sales Representative.

For Listings/Approval Details and Limitations, visit our website at www.asc-es.com or contact an ASC Engineered Solutions Sales Representative.

NOTE: All Sock-it fittings are UL/ULC Listed and FM Approved for 175 psi working pressure when used to join XL Pipe and Dyna-Flow Pipe.

Material Specifications

Housing

Cast iron ASTM A 126 CLASS A

Bolts

Case hardened carbon steel, dichromate finish

Gaskets

EPDM, as specified in accordance with ASTM D2000

Fitting Size

Nominal Size		O.D.
In./DN(mm)		In./mm
1/2	15	0.840 21.3
3/4	20	1.050 26.7
1	25	1.315 33.7
1 1/4	32	1.660 42.4
1 1/2	40	1.900 48.3
2	50	2.375 60.3
2 1/2	65	2.875 73.0

Note:

The Fitting Size Chart is used to determine the O.D. of the pipe that the fittings is to be used with. Gruvlok Fittings are identified by either the Nominal size in inches or the Pipe O.D. in mm.

Reducing Tee (Sock-it x Sock-it x NPT) Fig. 7106

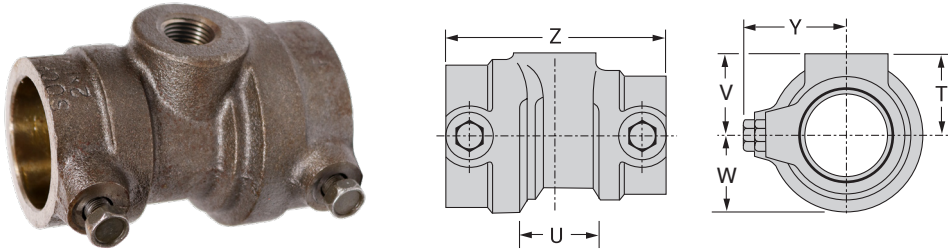

Nominal Size	Max. Working Pressure		Dimensions						Approx. Wt. Ea.
	UL/ULC Listed	FM Approved	T**	U*	V	W	Y	Z	
In./DN(mm)	PSI/bar	PSI/bar	In./mm	In./mm	In./mm	In./mm	In./mm	In./mm	Lbs./kg
1 1/4 x 1 x 1/2 32 x 25 x 15	300 2.1	300 2.1	1 25	1 3/8 35	1 7/16 37	1 1/4 32	1 13/16 46	4 1/4 108	2.1 1.0
1 1/4 x 1 x 3/4 32 x 25 x 20	300 20.7	300 20.7	7/8 22	1 3/8 35	1 7/16 37	1 1/4 32	1 13/16 46	4 1/4 108	2.1 1.0
1 1/4 x 1 x 1 32 x 25 x 25	300 20.7	300 20.7	7/8 22	1 3/8 35	1 7/16 37	1 1/4 32	1 13/16 46	4 1/4 108	2.0 0.9
1 1/2 x 1 1/4 x 1/2 40 x 32 x 15	300 20.7	300 20.7	1 1/8 29	1 3/8 35	1 9/16 40	1 3/8 35	1 15/16 49	4 3/8 111	2.5 1.1
1 1/2 x 1 1/4 x 3/4 40 x 32 x 20	300 20.7	300 20.7	1 25	1 3/8 35	1 9/16 40	1 3/8 35	1 15/16 49	4 3/8 111	2.4 1.1
1 1/2 x 1 1/4 x 1 40 x 32 x 25	300 20.7	300 20.7	1 25	1 3/8 35	1 9/16 40	1 3/8 35	1 15/16 49	4 3/8 111	2.2 1.0
2 x 1 1/2 x 1/2 50 x 40 x 15	175 12.1	250 17.2	1 1/4 32	1 3/8 35	1 3/4 44	1 5/8 41	2 3/16 56	4 9/16 116	3.2 1.5
2 x 1 1/2 x 3/4 50 x 40 x 20	175 12.1	250 17.2	1 1/8 29	1 3/8 35	1 3/4 44	1 5/8 41	2 3/16 56	4 9/16 116	3.1 1.4
2 x 1 1/2 x 1 50 x 40 x 25	175 12.1	250 17.2	1 1/8 29	1 3/8 35	1 3/4 44	1 5/8 41	2 3/16 56	4 9/16 116	3.0 1.4

Note:

- * "U" - Run take-out dimension.
- ** "T" - Outlet take-out dimension.

Stainless Steel Flexible Coupling Fig. 7001SS

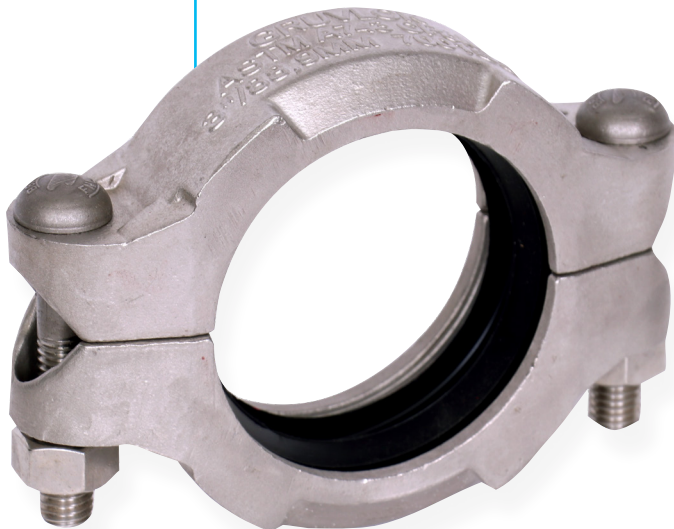

The Figure 7001SS Flexible Coupling is a Stainless Steel coupling made of ASTM A-743 / A743M cast stainless steel which is the cast equivalent to 316 Stainless Steel. It is designed for installation on Stainless Steel schedule 10 and 40 pipe and fittings. The stainless steel material is suitable for a variety of aggressive corrosive environments. The Figure 7001SS flexible coupling can accommodate some angular, rotational and axial pipe movement. It is capable of pressures up to 750 psi (41.4 bar) depending on pipe size and wall thickness.

Material Specifications

Stainless Steel Bolts

Stainless steel bolts are metric track head bolts conforming to ASTM A 193M Class 2, Type 316 Grade B8M.

Stainless Steel Nuts

Class 2 stainless steel nuts are heavy hex nuts conforming to ASTM A 194M, Type 316, Grade 8M.

Stainless Steel Housing

Type 316L, ASTM A 743/A 743M – Standard specification for castings, iron-chromium, iron-chromium-nickel, corrosion resistant; for general application Grade CR-8M. Tensile strength, minimum 70,000 psi (4826.3 bar). Yield strength, minimum 30,000 psi (2068.4 bar). Elongation in 2" (50mm) minimum 30%.

Material Specifications (Continued)

Gaskets: Materials

Properties as designated in accordance with ASTM D 2000.

Grade "EP" EPDM (Green and Red color code) –40°F to 250°F (Service Temperature Range) (–40°C to 121°C). Recommended for water service, diluted acids, alkaline solutions, oil-free air and many other chemical services.

NOT FOR USE IN PETROLEUM APPLICATIONS. For hot water applications the use of Gruvlok Extreme Temperature lubricant is recommended.

Grade "T" Nitrile (Orange color code) –20°F to 180°F (Service Temperature Range) (–29°C to 82°C). Recommended for petroleum applications, air with oil vapors and vegetable and mineral oils.

NOT FOR USE IN HOT WATER OR HOT AIR.

Grade "O" Fluoro-Elastomer (Blue color code)

20°F to 300°F (Service Temperature Range) (–7°C to 149°C). Recommended for high temperature resistance to oxidizing acids, petroleum oils, hydraulic fluids, halo enated hydrocarbons and lubricants.

Gasket Type

Standard C Style (1" – 8")
Flush Gap (1" – 8")

Lubrication

Standard Gruvlok
Gruvlok Xtreme™
(Do Not use with Grade "L")

Stainless Steel Flexible Coupling Fig. 7001SS

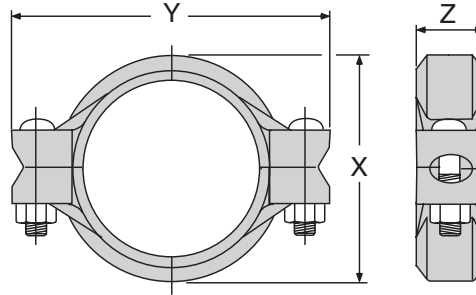

Fig. 7001SS Stainless Steel Flexible Coupling

Nominal Size	O.D.	Max. Working Pressure [†]	Max. End Load [†]	Max. End Gap*‡	Deflection from ϕ		Coupling Dimensions			Coupling Bolts		Approx. Wt. Ea.
					Per Coupling	of Pipe	X	Y	Z	Qty.	Size	
In./DN(mm)	In./mm	PSI/bar	Lbs./kN	In./mm	Degrees (°) - Minutes (')	In./ft-mm/m	In./mm	In./mm	In./mm		In./mm	Lbs./kg
1 25	1.315 33.4	750 51.7	1.019 4.5	0.13 3.3	5° 26'	0.90 95.1	2.70 68.6	3.72 94.5	1.75 44.4	2	3/8 x 2 1/4 M10 x 57	1.3 0.6
1 1/4 32	1.660 42.4	750 51.7	1.623 7.2	0.13 3.3	4° 19'	0.90 75.0	2.92 74.1	4.19 106.4	1.80 45.7	2	3/8 x 2 1/4 M10 x 57	1.7 0.7
1 1/2 40	1.900 48.3	750 51.7	2.127 9.5	0.13 3.3	3° 46'	0.79 65.8	3.04 77.2	4.42 112.8	1.80 45.7	2	3/8 x 2 1/4 M10 x 57	1.8 0.8
2 50	2.375 60.3	500 34.5	2.215 9.9	0.13 3.3	3° 1'	0.63 52.5	3.38 85.8	4.97 126.2	1.76 44.7	2	3/8 x 2 1/4 M10 x 57	2.1 0.8
2 1/2 65	2.875 73.0	500 34.5	3.246 14.4	0.13 3.3	2° 29'	0.52 43.3	4.00 101	5.68 144.2	1.76 44.7	2	3/8 x 2 1/4 M10 x 57	2.7 1.2
3 80	3.500 88.9	500 34.5	4.810 21.4	0.13 3.3	2° 3'	0.43 35.8	4.63 117.6	6.50 165.1	1.85 46.998	2	1/2 x 3 M12 x 76	3.8 1.7
4 100	4.500 114.3	500 34.5	7.952 35.3	0.25 6.4	3° 11'	0.67 55.8	5.69 148.1	7.90 200.6	2.00 50.8	2	1/2 x 3M12 x 76	5.2 1.8
5 125	5.563 141.3	450 31.0	10.933 48.7	0.25 6.4	2° 35'	0.54 45.0	6.96 176.8	9.71 246.6	2.04 51.8	2	5/8 x 3 1/4 M16 x 83	7.4 3.3
139.7 mm 125	5.500 139.7	450 31.0	10.691 47.6	0.25 6.4	2° 36'	0.55 45.5	6.81 173.0	9.75 247.7	2.06 52.3	2	- M16 x 83	7.2 3.3
6 150	6.625 168.3	450 31.0	15.512 69.0	0.25 6.4	2° 10'	0.45 37.5	8.02 203.7	10.75 273.0	2.04 51.8	2	5/8 x 3 1/4 M16 x 83	8.4 3.8
8 200	8.625 219.1	450 31.0	29.261 117	0.25 6.4	1° 40'	0.35 29.2	10.25 260.3	13.56 344.4	2.31 58.6	2	3/4 x 4 3/4 M20 x 121	15.2 6.69

Note:

- * Maximum available gap between pipe ends. Minimum gap = 0.
- † Maximum Pressure and End Load are total from all loads based on schedule 40 stainless steel pipe. Pressure ratings and end loads may differ for other pipe materials and/or wall thicknesses. Contact an ASC Engineered Solutions Sales Representative for details.
- ‡ Max End Gap and Deflection is for cut grooved standard weight stainless steel pipe. Values for roll grooved pipe will be half that of cut grooved.

Stainless Steel Rigid Coupling Fig. 7401SS

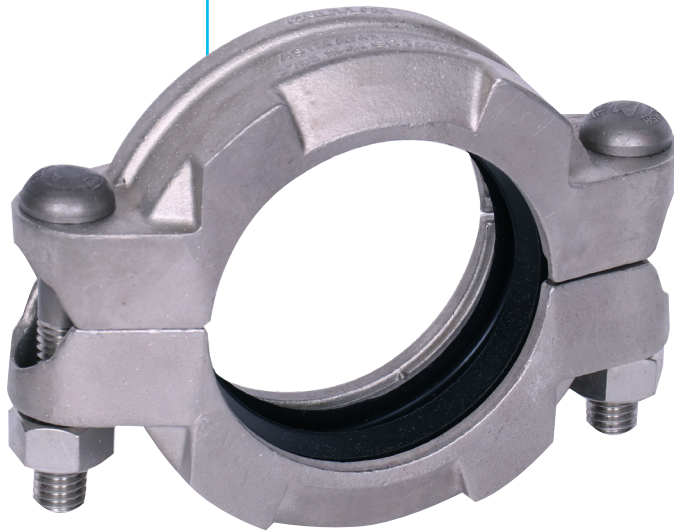

The Figure 7401SS Rigid Coupling is a Stainless Steel coupling made of ASTM A-743 / A743M cast stainless steel which is the cast equivalent to 316 Stainless Steel. It is designed for installation on grooved Stainless Steel Schedules 10 and 40 pipe and grooved fittings. The stainless steel material is suitable for a variety of aggressive corrosive environments. The Figure 7401SS provides a rigid joint connection by firmly gripping along the circumference of the pipe grooves. It is capable of pressures up to 750 psi (41.4 bar) depending on pipe size and wall thickness.

Material Specifications

Stainless Steel Bolts

Stainless steel bolts are metric track head bolts conforming to ASTM A 193M Class 2, Type 316 Grade B8M.

Stainless Steel Nuts

Class 2 stainless steel nuts are heavy hex nuts conforming to ASTM A 194M, Type 316, Grade 8M.

Stainless Steel Housing

Type 316L, ASTM A 743/A 743M – Standard specification for castings, iron–chromium, iron–chromium–nickel, corrosion resistant; for general application Grade CR–8M. Tensile strength, minimum 70,000 psi (4826.3 bar). Yield strength, minimum 30,000 psi (2068.4 bar). Elongation in 2" (50mm) minimum 30%.

Gaskets: Materials

Properties as designated in accordance with ASTM D 2000.

Grade "EP" EPDM (Green and Red color code) –40°F to 250°F (Service Temperature Range) (–40°C to 121°C). Recommended for water service, diluted acids, alkaline solutions, oil-free air and many other chemical services.

NOT FOR USE IN PETROLEUM APPLICATIONS.

For hot water applications the use of Gruvlok Extreme Temperature lubricant is recommended.

Grade "T" Nitrile (Orange color code) –20°F to 180°F (Service Temperature Range) (–29°C to 82°C). Recommended for petroleum applications, air with oil vapors and vegetable and mineral oils. NOT FOR USE IN HOT WATER OR HOT AIR.

Grade "O" Fluoro-Elastomer (Blue color code)

20°F to 300°F (Service Temperature Range) (–7°C to 149°C). Recommended for high temperature resistance to oxidizing acids, petroleum oils, hydraulic fluids, halo enated hydrocarbons and lubricants.

Gasket Type

Standard C Style (1¼" – 12")
Flush Gap (1¼" – 12")

Lubrication

Standard Gruvlok
Gruvlok Xtreme™
(Do Not use with Grade "L")

Stainless Steel Rigid Coupling Fig. 7401SS

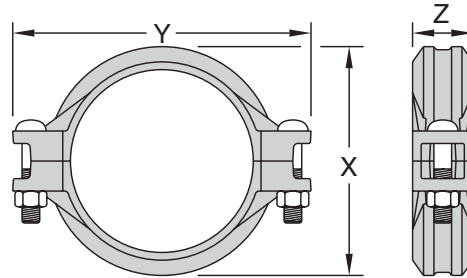

Fig. 7401SS Stainless Steel Rigid Coupling

Nominal Size	O.D.	Max. Working Pressure [†]	Max. End Load [†]	Max. End Gap*‡	Coupling Dimensions			Qty.	Coupling Bolts		Approx. Wt. Ea.
					X	Y	Z		Size	Lbs./kg	
In./DN(mm)	In./mm	PSI/bar	Lbs./kN	In./mm	In./mm	In./mm	In./mm		In./mm	Lbs./kg	
1¼ 32	1.660 42.4	750 51.7	1.623 7.22	0.06 1.5	3.02 76.7	4.38 111.3	1.81 46.0	2	¾ x 2¼ M10 x 57	2.0 0.9	
1½ 40	1.900 48.3	750 51.7	2.127 9.46	0.08 2.0	3.14 79.7	4.62 117.3	1.81 46.0	2	¾ x 2¼ M10 x 57	2.1 0.9	
2 50	2.375 60.3	750 51.7	3.323 14.78	0.13 3.3	3.63 92.2	5.12 130.0	1.88 47.8	2	¾ x 2¼ M10 x 57	2.5 1.1	
2½ 65	2.875 73.0	600 41.4	3.895 17.3	0.13 3.3	4.28 108.7	5.70 144.8	1.88 47.8	2	¾ x 2¼ M10 x 57	3.2 1.5	
3 80	3.500 88.9	600 41.4	5.772 25.7	0.13 3.3	4.90 111.7	6.50 165.1	1.88 47.8	2	½ x 3 M12 x 76	4.3 1.9	
4 100	4.500 114.3	600 41.4	9.542 42.4	0.19 4.8	6.08 154.4	7.82 198.6	1.97 44.9	2	½ x 3 M12 x 76	5.7 2.6	
5 125	5.563 141.3	600 41.4	14.583 64.9	0.19 4.8	7.20 182.8	9.71 246.6	2.04 51.8	2	⅝ x 3¼ M16 x 83	8.2 3.7	
6 150	6.625 168.3	600 41.4	20.682 92.0	0.19 4.8	8.27 210.1	10.88 276.3	2.13 54.1	2	⅝ x 3¼ M16 x 83	9.2 4.2	
8 200	8.625 219.1	600 41.4	35.054 156	0.19 4.8	10.51 266.9	13.56 344.4	2.62 66.5	2	¾ x 4¾ M20 x 121	19.4 8.8	
10 250	10.750 273.0	600 41.4	54.455 242	0.13 3.3	12.97 329.4	16.40 416.6	2.62 66.5	2	1 x 6½ M24 x 165	32.2 14.6	
12 300	12.750 323.9	600 41.4	76.603 340	0.13 3.3	15.42 391.7	18.84 478.5	2.62 66.5	2	1 x 6½ M24 x 165	42.2 19.1	

Note:

* Maximum available gap between pipe ends. Minimum gap = 0.

† Maximum Pressure and End Load are total from all loads based on schedule 40 stainless steel pipe. Pressure ratings and end loads may differ for other pipe materials and/or wall thicknesses. Contact an ASC Engineered Solutions Sales Representative for details.

‡ Max End Gap and Deflection is for cut grooved standard weight stainless steel pipe. Values for roll grooved pipe will be half that of cut grooved.

Stainless Steel Method Fittings Figs. 7050SS, 7051SS, 7060SS, 7061SS, 7072SS, 7073SS, 7074SS, 7084SS, 7788SS



Material Specifications

Fabricated Fittings

304/316L stainless steel conforming to ASTM A 312, Schedule 10 and Schedule 40

Full Flow Fittings

304/316L stainless steel conforming to ASTM A 403 WPW or A 403 CR

Maximum Working Pressure

Maximum working pressure is determined by the lowest rated component in a connected system. Please refer to individual component sheets to determine the appropriate value.

For Listings/Approval Details and Limitations, visit our website at www.asc-es.com or contact an ASC Engineered Solutions™ Sales Representative.

Gruvlok Stainless Steel, Full-Flow Grooved fittings are made of lightweight, corrosion-resistant Type 304 and 316 stainless steel. The assortment of available fittings provides economical and efficient methods to change direction in, add outlets to, reduce, or cap piping systems.

Fittings are available in full-flow and fabricated versions in 304 and 316L S.S. Fabricated fittings are available with Schedule 10 or Schedule 40 wall thickness.

Stainless Steel Method Fittings (Ordering Information)

Sample Part Number	Origin	2" Size	7050SS - Item	40 Schedule	04 SST
2" 7050SS-4004	A - Global No Letter - Domestic	1 1/4" - 12"	7050SS - 90° Elbow	10 - Sch. 10	04 - Type 304
			7051SS - 45° Elbow	40 - Sch. 40	16 - Type 316
			7060SS - Straight Tee		
			7061SS - Reducing Tee		
			7072SS - Concentric Reducer		
			7073SS - Eccentric Reducer		
			7074SS - Steel Cap		
			7084SS - Flange Adapter		
			7788SS - Flange Adapter		

- Introduction
- Couplings
- Outlets
- Fittings
- Valves & Accessories
- High Pressure
- CTS Copper System
- DI-Electric Nipples
- Plan-End Fittings
- HDPE Couplings
- Socket-It® Fittings
- Stainless Steel Method**
- Roll Groovers
- Installation & Assembly
- Special Coatings
- Design Services
- Technical Data
- Master Format 3 Part Specs.
- Pictorial Index

Fig. 7050SS

90° Stainless Steel Elbow

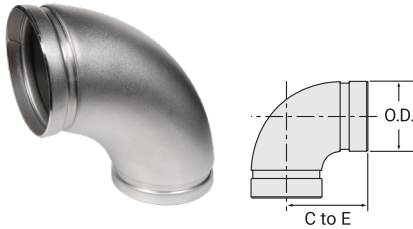

Fig. 7051SS

45° Stainless Steel Elbow

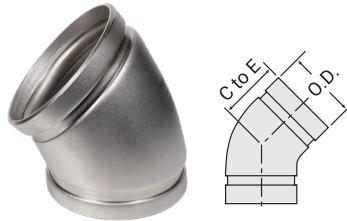
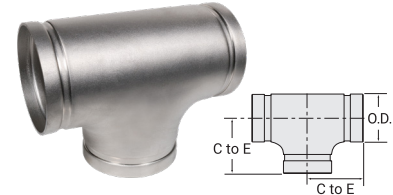

Fig. 7060SS

Stainless Steel Tee



Nominal Size	O.D.	Center to End	Approx. Wt. Ea.
In./DN(mm)	In./mm	In./mm	Lbs./kg
1	1.315	2.88	1
25	33.4	73.2	0.45
1¼	1.660	3.13	1
32	42.2	79.5	0.45
1½	1.900	3.50	1
40	48.3	88.9	0.45
2	2.375	4.50	1.1
50	60.3	114.3	0.5
2½	2.875	5.00	1.7
65	73.0	127.0	0.77
3	3.500	4.50	2.6
80	88.9	114.3	1.18
4	4.500	6.00	4.7
100	114.3	152.4	2.13
5	5.563	7.50	8.4
125	141.3	190.5	3.81
6	6.625	9.00	10.3
150	168.3	228.6	4.67
8	8.625	12.00	17.6
200	219.1	304.8	7.98
10	10.750	15.00	49.2
250	273.0	381.0	22.32
12	12.750	18.00	78.4
300	323.9	457.2	35.56

Nominal Size	O.D.	Center to End	Approx. Wt. Ea.
In./DN(mm)	In./mm	In./mm	Lbs./kg
1	1.315	2.00	0.6
25	33.4	50.8	0.27
1¼	1.660	2.00	0.8
32	42.2	50.8	0.36
1½	1.900	2.13	1
40	48.3	54.1	0.45
2	2.375	2.75	1.2
50	60.3	69.9	0.54
2½	2.875	2.88	1.3
65	73.0	73.2	0.59
3	3.500	2.00	1.3
80	88.9	50.8	0.59
4	4.500	2.50	2.3
100	114.3	63.5	1.04
5	5.563	3.13	4.2
125	141.3	79.5	1.91
6	6.625	3.75	5.1
150	168.3	95.3	2.31
8	8.625	5.00	13.8
200	219.1	127	6.26
10	10.750	6.25	24.6
250	273.0	158.8	11.16
12	12.750	7.50	39.2
300	323.9	190.5	17.78

Nominal Size	O.D.	Center to End	Approx. Wt. Ea.
In./DN(mm)	In./mm	In./mm	Lbs./kg
1	1.315	2.25	0.7
25	33.4	57.2	0.32
1¼	1.66	3.13	1.3
32	42.2	79.5	0.59
1½	1.9	3.38	1.6
40	48.3	85.9	0.73
2	2.375	2.75	2.3
50	60.3	69.9	1.04
2½	2.875	3.13	2.8
65	73.0	79.5	1.27
3	3.5	3.75	3.1
80	88.9	95.3	1.41
4	4.5	4.50	4.9
100	114.3	114.3	2.22
5	5.563	5.89	7.1
125	141.3	149.6	3.22
6	6.625	5.89	11.7
150	168.3	149.6	5.31
8	8.625	7.76	20.0
200	219.1	197.1	9.07
10	10.75	8.88	34.4
250	273.0	225.6	15.60
12	12.75	10.38	52.5
300	323.9	263.7	23.81

Fig. 7061SS
Stainless Steel Reducing Tee

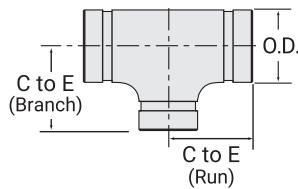

Nominal Size	O.D. 1	O.D. 2	C to E	C to B	Approx. Wt. Ea.
In./DN(mm)	In./mm	In./mm	In./mm	In./mm	Lbs./kg
1½ x 1½ x 1 40 x 40 x 25	1.900 48.3	1.315 33.4	2.75 69.9	2.75 69.9	1.5 0.68
1½ x 1½ x 1¼ 40 x 40 x 32	1.900 48.3	1.660 42.4	2.75 69.9	2.75 69.9	1.7 0.77
2 x 2 x 1 50 x 50 x 25	2.375 60.3	1.315 33.4	3.25 82.6	3.25 82.6	2.2 1.00
2 x 2 x 1¼ 50 x 50 x 32	2.375 60.3	1.660 42.2	3.25 82.6	3.25 82.6	2.4 1.09
2 x 2 x 1½ 50 x 50 x 40	2.375 60.3	1.900 48.3	2.75 69.9	2.75 69.9	2.4 1.09
2½ x 2½ x 1 50 x 50 x 40	2.875 73.0	1.315 33.4	3.75 95.3	3.75 95.3	3.1 1.41
2½ x 2½ x 1½ 50 x 50 x 40	2.875 73.0	1.900 48.3	3.75 95.3	3.75 95.3	3.4 1.54
2½ x 2½ x 2 50 x 50 x 40	2.875 73.0	2.375 60.3	3.07 78.0	3.07 78.0	3.6 1.63
3 x 3 x 1 80 x 80 x 25	3.500 88.9	1.315 33.4	4.25 108.0	4.25 108.0	4.3 1.95
3 x 3 x 1¼ 80 x 80 x 32	3.500 88.9	1.660 42.2	4.25 108.0	4.25 108.0	4.3 1.95
3 x 3 x 1½ 80 x 80 x 40	3.500 88.9	1.900 48.3	4.25 108.0	4.25 108.0	4.4 2.00
3 x 3 x 2 80 x 80 x 50	3.500 88.9	2.375 60.3	3.77 95.8	3.23 82.0	4.4 2.00
3 x 3 x 2½ 80 x 80 x 65	3.500 88.9	2.875 73.0	3.77 95.8	3.23 82.0	4.4 2.00
4 x 4 x 2 100 x 100 x 50	4.500 114.3	2.375 60.3	4.47 113.5	3.82 97.0	4.4 2.00
4 x 4 x 2½ 100 x 100 x 65	4.500 114.3	2.875 73.0	4.47 113.5	3.82 97.0	4.6 2.09
4 x 4 x 3 100 x 100 x 80	4.500 114.3	3.500 88.9	4.47 113.5	3.88 98.6	4.9 2.22
6 x 6 x 1½ 150 x 150 x 40	6.625 168.3	1.900 48.3	5.91 150.1	5.91 150.1	9.3 4.22
6 x 6 x 2 150 x 150 x 50	6.625 168.3	2.375 60.3	5.91 150.1	5.91 150.1	9.3 4.22
6 x 6 x 3 150 x 150 x 80	6.625 168.3	3.5 88.9	5.91 150.1	4.88 124.0	9.3 4.22
6 x 6 x 4 150 x 150 x 100	6.625 168.3	4.500 114.3	5.91 150.1	5.12 130.0	9.3 4.22
8 x 8 x 4 200 x 200 x 100	8.625 219.1	4.500 114.3	7.79 197.9	6.31 160.3	18.1 8.21
8 x 8 x 6 200 x 200 x 150	8.625 219.1	6.625 168.3	7.79 197.9	6.62 168.1	18.1 8.21
10 x 10 x 6 250 x 250 x 150	10.750 273.0	6.625 168.3	8.89 225.8	7.70 195.6	29.3 13.29
10 x 10 x 8 250 x 250 x 200	10.750 273.0	8.625 219.1	8.89 225.8	8.59 218.2	31.7 14.38
12 x 12 x 8 300 x 300 x 200	12.750 323.9	8.625 219.1	10.39 263.9	9.51 242	44.0 19.96
12 x 12 x 10 300 x 300 x 250	12.750 323.9	10.750 273.0	10.39 263.9	9.89 251.2	44.0 19.96

- Introduction
- Couplings
- Outlets
- Fittings
- Valves & Accessories
- High Pressure
- CTS Copper System
- DI-Electric Nipples
- Plan-End Fittings
- HDPE Couplings
- Socket-It® Fittings
- Stainless Steel Method
- Roll Groovers
- Installation & Assembly
- Special Coatings
- Design Services
- Technical Data
- Master Format 3 Part Specs.
- Pictorial Index

Fig. 7074SS
Stainless Steel Cap

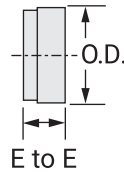
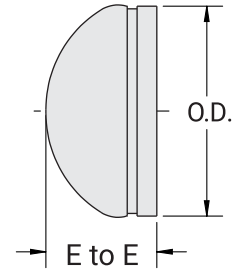

Fig. 7074SS
Stainless Steel Cap (Large)



Nominal Size	O.D.	End to End	Approx. Wt. Ea.
In./DN(mm)	In./mm	In./mm	Lbs./kg
1	1.315	1.08	0.2
25	33.4	27.4	0.09
1¼	1.660	1.08	0.4
32	42.2	27.4	0.18
1½	1.900	1.08	0.5
40	48.3	27.4	0.23
2	2.375	1.08	0.7
50	60.3	27.4	0.32
2½	2.875	1.08	1.0
65	73.0	27.4	0.45
76.1mm	3.000	2.36	3.1
65	76.2	60.0	1.41
3	3.500	1.08	2.0
80	88.9	27.4	0.91
4	4.500	1.13	3.1
100	114.3	28.7	1.41
5	5.563	3.00	1.7
125	141.3	76.2	0.77
6	6.625	3.50	1.9
150	168.3	88.9	0.86
8	8.625	4.00	3.1
200	219.1	101.6	1.41
10	10.750	5.00	6.0
250	273.0	127.0	2.72
12	12.750	6.00	7.8
300	323.9	152.4	3.54

Nominal Size	O.D.	End to End	Approx. Wt. Ea.
In./DN(mm)	In./mm	In./mm	Lbs./kg
4	4.500	1.13	3.1
100	114.3	28.7	1.41
5	5.563	3.00	1.7
125	141.3	76.2	0.77
6	6.625	3.50	1.9
150	168.3	88.9	0.86
8	8.625	4.00	3.1
200	219.1	101.6	1.41
10	10.750	5.00	6.0
250	273.0	127.0	2.72
12	12.750	6.00	7.8
300	323.9	152.4	3.54

Fig. 7084SS

Groove x Class 150 Stainless Steel Flange Adapter

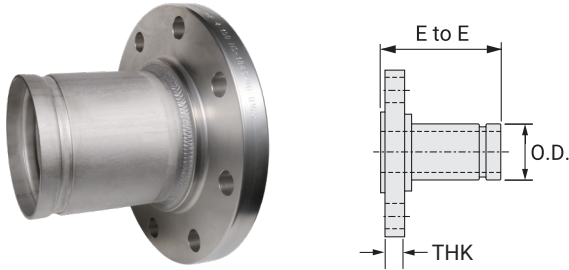

Nominal Size	O.D.	End to End	THK	Mating Flange Bolt	Approx. Wt. Ea.
In./DN(mm)	In./mm	In./mm	In./mm	In./mm	Lbs./kg
--	--	--	--	--	--
--	--	--	--	--	--
--	--	--	--	--	--
2	2.380	2.490	0.500	4	2.7
50	60.5	63.2	12.7		1.22
2 ½	2.880	2.400	0.440	8	3.0
65	73.2	61.0	11.2		1.36
3	3.500	2.680	0.560	8	6.0
80	88.9	68.1	14.2		2.72
--	--	--	--	--	--
4	4.500	2.620	0.640	8	7.0
100	114.3	66.5	16.3		3.18
5	5.560	2.610	0.670	8	10.0
125	141.2	66.3	17.0		4.54
6	6.630	2.630	0.690	8	12.0
150	168.4	66.8	17.5		5.44
8	8.630	3.120	0.810	8	21.0
200	219.2	79.2	20.6		9.53
--	--	--	--	--	--
--	--	--	--	--	--

Fig. 7788SS

Groove Cast 316 Stainless Steel Flange Adapter

Notes

Maximum Allowable Working Pressure: 300 psi.
Material: Cast stainless steel equivalent to 316 alloy.

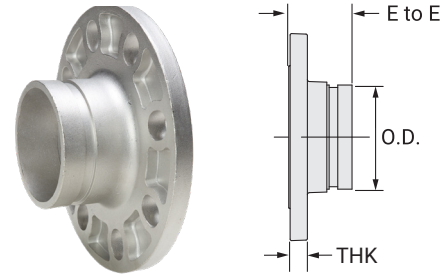

Nominal Size	O.D.	End to End	THK	Mating Flange Bolt	Approx. Wt. Ea.
In./DN(mm)	In./mm	In./mm	In./mm	In./mm	Lbs./kg
1	1.315	3.000	0.500	4	2.5
25	33.4	76.2	12.7		1.13
1 ¼	1.660	4.000	0.560	4	3.8
32	42.2	101.6	14.2		1.72
1 ½	1.900	4.000	0.620	4	4.1
40	48.3	101.6	15.7		1.86
2	2.375	4.000	0.690	4	6.0
50	60.3	101.6	17.5		2.72
2 ½	2.875	4.000	0.810	4	9.2
65	73.0	101.6	20.6		4.17
3	3.500	4.000	0.880	4	10.4
80	88.9	101.6	22.4		4.72
3 ½	4.000	4.000	0.880	4	14.0
90	101.6	101.6	22.4		6.35
4	4.500	6.000	0.880	8	19.1
100	114.3	152.4	22.4		8.66
5	5.563	6.000	0.880	8	23.0
125	141.3	152.4	22.4		10.43
6	6.625	6.000	0.940	8	28.1
150	168.3	152.4	23.9		12.75
8	8.625	6.000	1.060	8	43.7
200	219.1	152.4	26.9		19.82
10	10.750	8.000	1.12	12	68.2
250	273.0	203.2	28.4		30.94
12	12.750	8.000	1.19	12	96.1
300	323.9	203.2	30.2		43.59

- Introduction
- Couplings
- Outlets
- Fittings
- Valves & Accessories
- High Pressure
- CTS Copper System
- DI-Electric Nipples
- Plan-End Fittings
- HDPE Couplings
- Socket-It® Fittings
- Stainless Steel Method
- Roll Groovers
- Installation & Assembly
- Special Coatings
- Design Services
- Technical Data
- Master Format 3 Part Specs.
- Pictorial Index

Fig. 7072SS
Stainless Steel Concentric Reducer

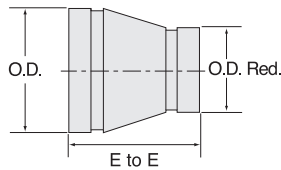

Nominal Size	O.D. 1	O.D. 2	End to End	Approx. Wt. Ea.
In./DN(mm)	In./mm	In./mm	In./mm	Lbs./kg
1½ x 1 40 x 25	1.900 48.3	1.315 33.4	3.75 95.3	1.4 0.64
1½ x 1¼ 40 x 32	1.900 48.3	1.660 42.2	3.75 95.3	1.4 0.64
2 x 1 50 x 25	2.375 60.3	1.315 33.4	3.75 95.3	1.5 0.68
2 x 1¼ 50 x 32	2.375 60.3	1.660 42.2	3.75 95.3	2.5 1.13
2 x 1½ 50 x 40	2.375 60.3	1.900 48.3	5.00 127.0	2.5 1.13
2½ x 1½ 65 x 40	2.875 73.0	1.900 48.3	5.00 127.0	3.5 1.59
2½ x 2 65 x 50	2.875 73.0	2.375 60.3	5.00 127.0	3.5 1.59
3 x 1 80 x 25	3.500 88.9	1.315 33.4	5.00 127.0	3.5 1.59
3 x 1¼ 80 x 32	3.500 88.9	1.660 42.2	5.00 127.0	4.3 1.95
3 x 1½ 80 x 40	3.500 88.9	1.900 48.3	5.00 127.0	4.4 2.00
3 x 2 80 x 50	3.500 88.9	2.375 60.3	5.00 127.0	4.8 2.18
3 x 2½ 80 x 65	3.500 88.9	2.875 73.0	5.00 127.0	4.8 2.18
4 x 2 100 x 50	4.500 114.3	2.375 60.3	5.00 127.0	4.8 2.18
4 x 2½ 100 x 65	4.500 114.3	2.875 73.0	5.00 127.0	4.8 2.18
4 x 3 100 x 80	4.500 114.3	3.500 88.9	5.00 127.0	5.0 2.27
5 x 3 125 x 80	5.563 141.3	3.500 88.9	9.00 228.6	7.0 3.18
5 x 4 125 x 100	5.563 141.3	4.500 114.3	9.00 228.6	7.0 3.18
6 x 2 150 x 50	6.625 168.3	2.375 60.3	5.50 139.7	4.2 1.91
6 x 2½ 150 x 65	6.625 168.3	2.875 73.0	5.50 139.7	4.2 1.91
6 x 3 150 x 80	6.625 168.3	3.500 88.9	5.50 139.7	4.0 1.81
6 x 4 150 x 100	6.625 168.3	4.500 114.3	5.50 139.7	4.2 1.91
8 x 4 200 x 100	8.625 219.1	4.500 114.3	6.00 152.4	9.6 4.35
8 x 6 200 x 150	8.625 219.1	6.625 168.3	6.00 152.4	9.6 4.35
10 x 4 250 x 100	10.750 273.0	4.500 114.3	7.00 177.8	8.8 3.99
10 x 6 250 x 150	10.750 273.0	6.625 168.3	7.00 177.8	11.5 5.22
10 x 8 250 x 200	10.750 273.0	8.625 219.1	7.00 177.8	11.5 5.22
12 x 6 300 x 150	12.750 323.9	6.625 168.3	8.00 203.2	13.0 5.90
12 x 8 300 x 200	12.750 323.9	8.625 219.1	8.00 203.2	13.0 5.90
12 x 10 300 x 250	12.750 323.9	10.750 273.0	8.00 203.2	17.0 7.71

Fig. 7073SS
Stainless Steel Eccentric Reducer

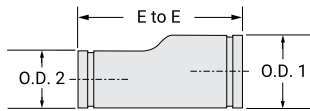

Nominal Size	O.D. 1	O.D. 2	End to End	Approx. Wt. Ea.
In./DN(mm)	In./mm	In./mm	In./mm	Lbs./kg
1½ x 1 40 x 25	1.900 48.3	1.315 33.4	3.75 95.3	1.4 0.64
1½ x 1¼ 40 x 32	1.900 48.3	1.660 42.2	3.75 95.3	1.4 0.64
2 x 1 50 x 25	2.375 60.3	1.315 33.4	3.75 95.3	1.5 0.68
2 x 1¼ 50 x 32	2.375 60.3	1.660 42.2	3.75 95.3	2.5 1.13
2 x 1½ 50 x 40	2.375 60.3	1.900 48.3	3.75 95.3	2.5 1.13
2½ x 2 65 x 50	2.875 73.0	2.375 60.3	5.00 127.0	3.5 1.59
3 x 1 80 x 25	3.500 88.9	1.315 33.4	5.00 127.0	4.3 1.95
3 x 2 80 x 50	3.500 88.9	2.375 60.3	5.00 127.0	4.3 1.95
3 x 2½ 80 x 65	3.500 88.9	2.875 73.0	5.00 127.0	4.5 2.04
4 x 2 100 x 50	4.500 114.3	2.375 60.3	5.00 127.0	4.8 2.18
4 x 2½ 100 x 65	4.500 114.3	2.875 73.0	5.00 127.0	5.8 2.63
4 x 3 100 x 80	4.500 114.3	3.5 88.9	5.00 127.0	5.9 2.68
5 x 3 125 x 80	5.563 141.3	3.5 88.9	9.00 228.6	6.7 3.04
5 x 4 125 x 100	5.563 141.3	4.5 114.3	9.00 228.6	7.0 3.18
6 x 2 150 x 50	6.625 168.3	2.375 60.3	9.00 228.6	7.0 3.17
6 x 2½ 150 x 65	6.625 168.3	2.875 73.0	9.00 228.6	7.0 3.17
6 x 3 150 x 80	6.625 168.3	3.5 88.9	9.00 228.6	7.0 3.18
6 x 4 150 x 100	6.625 168.3	4.5 114.3	9.00 228.6	7.0 3.18
8 x 3 200 x 80	8.625 219.1	3.5 88.9	10.00 254.0	9.3 4.22
8 x 4 200 x 100	8.625 219.1	4.5 114.3	10.00 254.0	11.6 5.26
8 x 6 200 x 150	8.625 219.1	6.625 168.3	10.00 254.0	11.8 5.35
10 x 6 250 x 150	10.75 273.0	6.625 168.3	13.00 330.2	12.5 5.67
10 x 8 250 x 200	10.75 273.0	8.625 219.1	13.00 330.2	11.5 5.22
12 x 6 300 x 150	12.750 323.9	6.625 168.3	14.00 355.6	21.1 9.57
12 x 8 300 x 200	12.750 323.9	8.625 219.1	14.00 355.6	21.1 9.57
12 x 10 300 x 250	12.750 323.9	10.75 273.0	14.00 355.6	21.1 9.57

Grooved End Stainless Steel Butterfly Valve with Lever Handle Model B480



For additional listings or approvals, visit our website at www.asc-es.com

The Model B480 Grooved End Stainless Steel Butterfly Valve with Lever Handle is a grooved-end stainless steel butterfly valve designed for 300 psi service, supplied with a 10-position locking lever handle. The end-to-end dimensions conform to MSS SP-67. The body is investment cast in grade CF8M (Type 316) to ASTM A743 with integral neck and ISO mounting top flange. The neck height allows for pipe insulation up to two inches thick. The disc is a dual-seal type, encapsulated either with Grade “EN” EPDM for cold water services or with Grade “T” Nitrile for oil services. The Model B480 Stainless Steel Butterfly Valves with standard disc and Grade “EN” EPDM seat are UL classified to ANSI/NSF 61 and ANSI/NSF 372.

Maximum Working Pressure: 300 psi (20 bar)

Materials of Construction

Valve Body

CF8M (Type 316) Stainless Steel conforming to ASTM A743 or A351, or A744 which is UL Classified in accordance with ANSI/ NSF 61 and ANSI/NSF 372 for potable water use up to 180°F (82°C)

Stems

Stainless Steel Type 410 conforming to ASTM A582

Disc

CF8M (Type 316) Stainless Steel conforming to ASTM A743 or A351, or A744 which is UL Classified in accordance with ANSI/NSF 61 and Annex G for potable water use up to 180°F (82°C)

Disc Encapsulation

Grade “EN” EPDM Rubber Classified in accordance with ANSI/NSF 61 and ANSI/NSF 372 for potable water use up to 180°F (82°C), or Grade “T” Nitrile

O-Rings

EPDM

Seat Material

- Grade “EN” EPDM – For service temperatures from -30°F to 230°F (-34°C to 110°C). For general service. Recommended for water service, dilute acids, alkalis, oil-free air and many chemical services.

Note: Not recommended for use in petroleum services.

- Grade “T” Nitrile – For service temperatures from -20°F to 180°F (-29°C to 82°C). Recommended for petroleum products, air with oil vapors, vegetable oils, and mineral oils.

Note: Not recommended for use in hot water services.

Contact an ASC Engineered Solutions Sales Representative for specific recommendations on seat material.

Grooved End Stainless Steel Butterfly Valve with Lever Handle Model B480

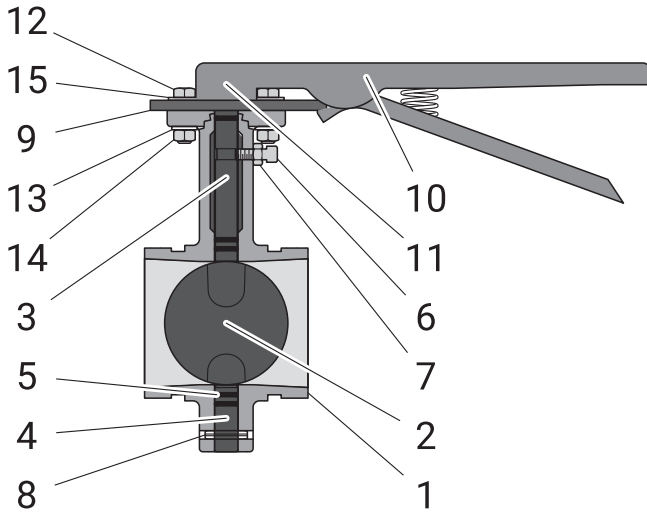

Material Specifications

- 1. Body**
Stainless Steel
- 2. Disc**
Stainless Steel
- 3. Upper Shaft**
Stainless Steel
- 4. Lower Shaft**
Stainless Steel
- 5. O-Ring**
EPDM
- 6. Hex Socket Set Screw**
Stainless Steel
- 7. Hex Nut**
Stainless Steel
- 8. Roll Pin**
Spring Steel
- 9. Throttle Plate**
Stainless Steel
- 10. Lever-Lock Handle Assembly**
Stainless Steel
- 11. Roll Pin**
Spring Steel
- 12. Hex Bolt**
Stainless Steel
- 13. Lock Washer**
Stainless Steel
- 14. Hex Nut**
Stainless Steel
- 15. Flat Washer**
Stainless Steel

B480 Shaft Size

Size	Shaft Size SJ-400 (B480)
2"	φ12.7
2½"	φ12.7
3"	φ12.7
4"	φ19.0
5"	φ19.0
6"	φ19.0
8"	φ19.0

Round shaft with pin.

- Introduction
- Couplings
- Outlets
- Fittings
- Valves & Accessories
- High Pressure
- CTS Copper System
- Di-Electric Nipples
- Plan-End Fittings
- HDPE Couplings
- Socket-It® Fittings
- Stainless Steel Method
- Roll Groovers
- Installation & Assembly
- Special Coatings
- Design Services
- Technical Data
- Master Format 3 Part Specs.
- Pictorial Index

Grooved End Stainless Steel Butterfly Valve with Lever Handle Model B480

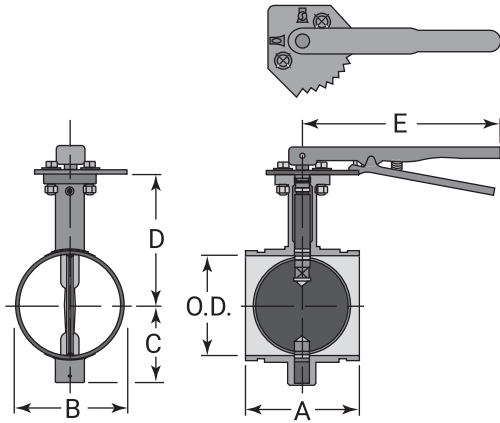

Valve Size	O.D.	Operating Torque	Dimensions					Approx. Wt. Ea.
			A	B	C	D	E	
In./mm	In./mm	In-lb/Nm	In./mm	In./mm	In./mm	In./mm	In./mm	Lbs./Kg
2	2.375	78	3.19	2.756	2.480	4.17	10.0	5.0
50	60.3	8.80	81	70	63	106	254	2,3
2½	2.875	84	3.81	3.386	2.677	4.28	10.0	7.0
65	73.0	9.50	97	86	68	111	254	3,2
76.1mm	3.000	84	3.81	3.386	2.677	4.28	10.0	7.0
65	76.1	9.50	97	86	68	111	254	3,2
3	3.500	95	3.81	3.858	2.992	4.97	10.0	6.6
80	88.9	10.7	97	98	76	126	254	3,5
4	4.500	200	4.56	4.882	3.504	5.33	10.0	11.0
100	114.3	22.6	116	124	89	135	254	5,0
165.1mm	6.500	310	5.81	7.008	4.488	6.62	10.0	20.2
150	165.1	34.9	148	178	114	168	254	9,2
6	6.625	310	5.81	7.008	4.488	7.25	10.0	20.2
150	168.3	34.9	148	178	114	184	254	9,2

These torque values were derived from test data with non-lubricated valves in water, non-pressurized at ambient temperatures
 For information on alternative sizes, contact an ASC Engineered Solutions Sales Representative.
 Note: The torque values are based on liquid applications. For dry or non-lubricating applications add a 25% service factor to the above values.

Grooved End Stainless Steel Butterfly Valve with Lever Handle Model B480

Model B480 Grooved End Stainless Steel Butterfly Valve Nominal Pressure Loss Vs Flow

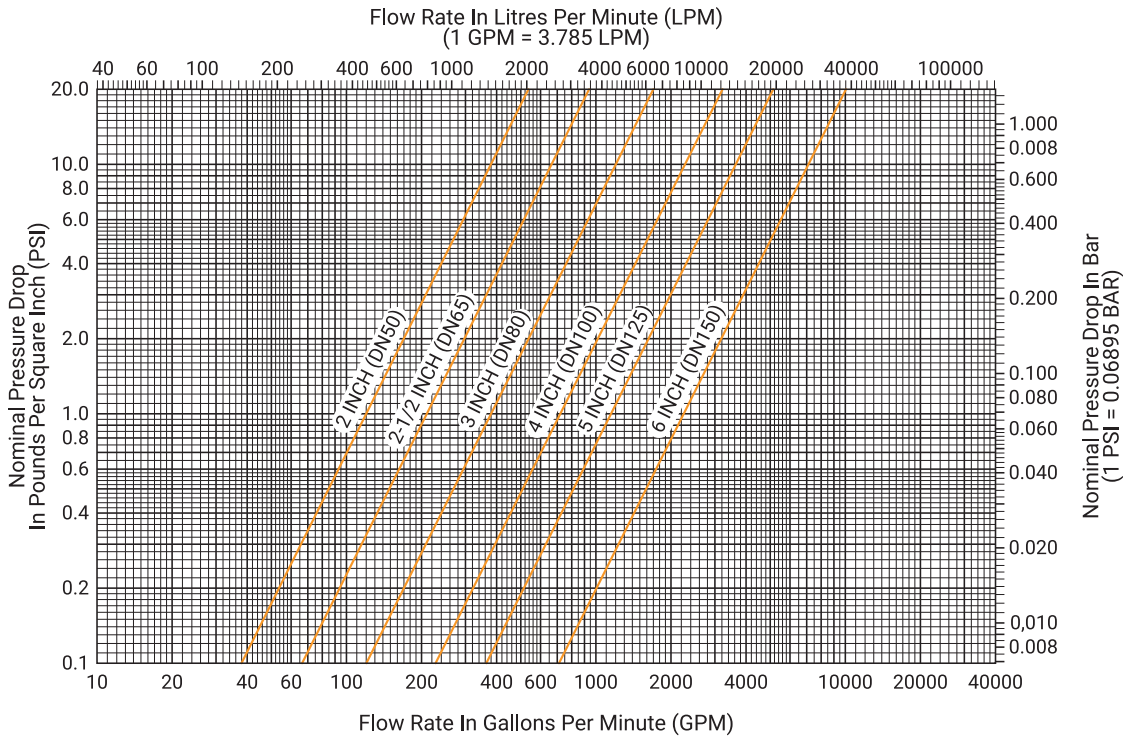

- Introduction
- Couplings
- Outlets
- Fittings
- Valves & Accessories
- High Pressure
- CTS Copper System
- Di-Electric Nipples
- Plan-End Fittings
- HDPE Couplings
- Socket-It® Fittings
- Stainless Steel Method**
- Roll Groovers
- Installation & Assembly
- Special Coatings
- Design Services
- Technical Data
- Master Format 3 Part Specs.
- Pictorial Index

Grooved End Stainless Steel Ball Valve with Lever Handle Model BV435

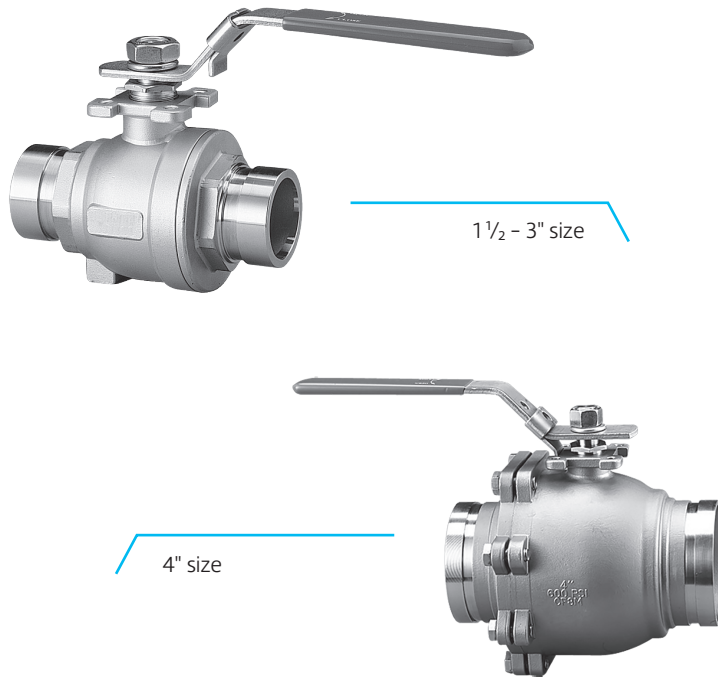

Material Specifications

Body

Cast Stainless Steel per ASTM A351-CF8M

Ball

Cast Stainless Steel per ASTM A351-CF8M

Upper Stems

Stainless steel per ASTM A276, Type 316

Operator

Stainless Steel Lever per ASTM A-276,
Type 304

Seats

1 1/2 to 3 Inches: Virgin PTFE,
4 Inches: Glass Filled PTFE

Seals

PTFE

O-Rings

EPDM

The Model BV435 Grooved End Stainless Steel Ball Valves with Lever Handle provide for efficient control of fluid in piping systems. Flow may be from either direction, and the valves may be positioned in any orientation. The valves are furnished with grooved ends for use with Gruvlok grooved couplings. The handle is provided with a device for padlocking in either the open or closed position.

Maximum Working Pressure: 600 psi (41.4 bar)

Grooved End Stainless Steel Ball Valve with Lever Handle Model BV435

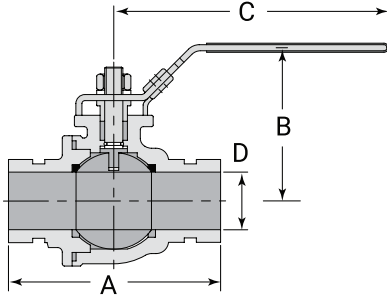

Size	O.D.	Dimensions				Operating Torque	Approx. Wt. Ea.
		A	B	C	D		
1½	1.900	5.50	3.70	7.60	1.50	62	6.6
40	48.3	140	94	193	38	7	3.0
2	2.375	6.15	4.13	7.60	1.97	150	8.8
50	60.3	156	105	193	50	17	4.0
2½	2.875	7.09	4.33	9.84	2.36	186	15.4
65	73.0	180	110	250	60	21	7.0
3	3.500	8.42	6.00	9.84	2.99	248	20.7
80	88.9	214	152	250	76	28	9.4
4	4.500	9.45	6.57	11.42	3.94	398	55
100	114.3	240	167	290	100	45	25.0

Weight includes the lever handle.

Model BV435 Grooved End Stainless Steel Ball Valve Nominal Pressure Loss vs Flow

Flow Rate In Litres Per Minute (LPM)
(1 GPM = 3.785 LPM)

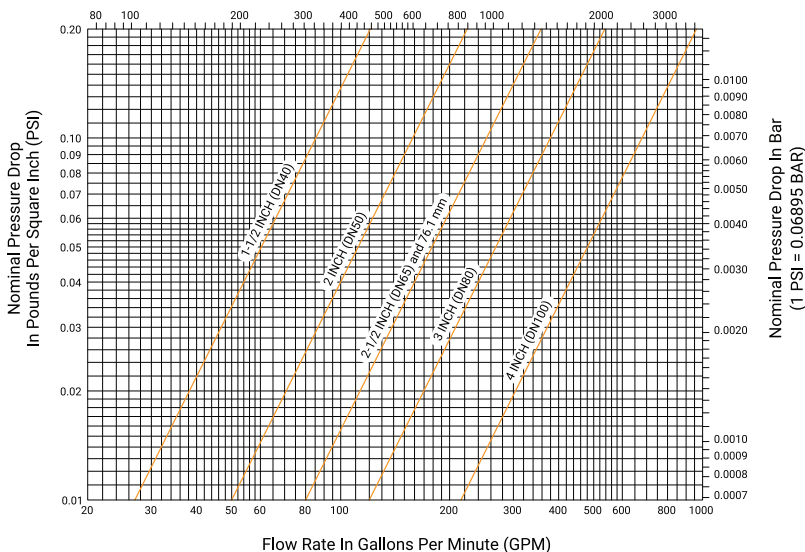

Roll Groovers Model 1007 Model 3007

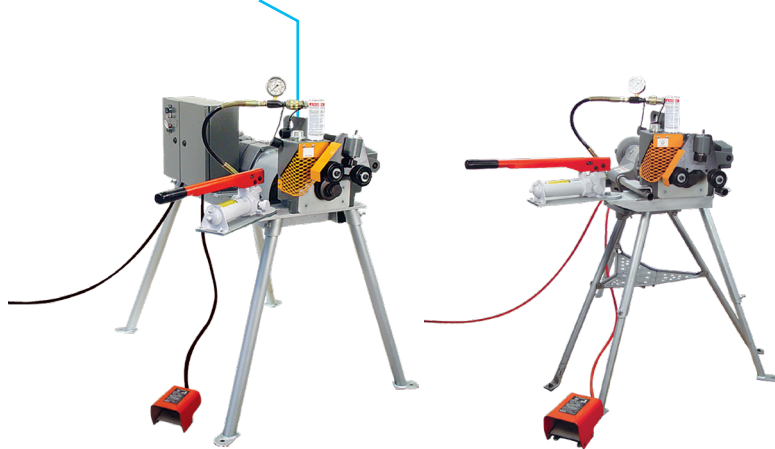

Model 1007

Model 3007

Optional Equipment

Steel Pipe

- 2"-12" Schedule 10 & 40 Rolls: Consisting of 2"-6" and 8"-12" roll sets.
- 14"-16" Steel Grooving Rolls (Model 1007 only).

CTS Copper System Option

- 2"-8" CTS Copper System Grooving Rolls, 2"-4" CTS Depth Gauge, and 5"-8" CTS Depth Gauge.

Stainless Steel System Option

- 2"-12" Schedule 10SS & 40SS: Consisting of 2"-6" and 8"-12" roll sets.

Other

- Optional 230 volt, 60Hz, 15 amp, single phase electrical panel with motor is available for the 1007 Roll Groover.

1007 Standard Equipment

Roll Groover complete with groove and drive rolls for 2" - 12" steel pipe, Steel/CTS Dual Guide Roll Assembly, one and one-half horsepower electric motor drive with foot switch. Two stage hydraulic hand pump, mounting base with footed support legs. Complete set-up and operating instructions; 2" - 6" rolls on tool, 8" - 12" rolls stored in box, and three depth gauges covering the range of 2" through 12" pipe are mounted on the tool.

Shipped in closed wood crate that can be used for storage or rental tool return. Shipping Weight: 620 lbs.

3007 Standard Equipment

Roll Groover complete with groove and drive rolls for 2" - 12" steel pipe, Steel/CTS Dual Guide Roll Assembly, two stage hydraulic hand pump, mounting base with footed support legs for direct attachment to your Ridgid 300 Power Drive. Complete set-up and operating instructions; 2" - 6" rolls on tool; 8" - 12" rolls stored in box, and three depth gauges covering the range of 2"-12" pipe are mounted on the tool. Required Ridgid® 300 Power Drive not included.

Shipped in closed wood crate that can be used for storage or rental tool return.

Shipping Weight: 330 lbs.

Gruvlok roll grooving technology is protected by U.S. Patents 5450738, 5570603, 5778715 and others pending.

Roll Groovers Model 1007 & 3007

Groover Capability

Pipe Material	Pipe Size/Wall Thickness (Schedule)											
	In. DN(mm)	2 50	2½ 65	3 80	4 100	5 125	6 150	8 200	10 250	12 300	14 350	16 400
Steel	Schedule 10, 40										Std.	Std.
Stainless	Steel Schedule 10S, 40S										n/a	n/a
Copper	K, L, M & DWV							n/a	n/a	n/a	n/a	

Note:

- All wall thickness shown are the maximum wall thickness for the indicated pipe material.
- Minimum wall thickness for each pipe materials and size is:
 - Steel: 2"-12" — Sch. 10, 14" & 16" Standard Wall
 - Stainless Steel: 2"-12" — Sch. 10S, 40
 - Copper: 2"-2½" — Type M
 - 3"-8" — Type DWV
- Contact an ASC Engineered Solutions™ Representative for information on grooving alternate materials.
- Some sizes may require optional equipment.
- Schedule 80 pipe and above must be cut grooved.

Steel Pipe Grooving Times (Min: Sec.)

Pipe Size (In./DN(mm)) – Sch. 40 (Std. Wall) Steel Pipe											
2 50	2½ 65	3 80	4 100	5 125	6 150	8 200	10 250	12 300	14 350	16 400	
0:20	0:20	0:25	0:30	1:00	1:20	1:35	1:50	2:20	2:40	3:00	

Note:

This chart shows approximate grooving times with the groover setup for the proper size and groove diameter and the pipe properly positioned on the groover. The times shown are average times from the start of rotation of the pipe in the grooving rolls to completed groove.

- Wide Grooving Range**
2" thru 16" standard wall & schedule 10 steel pipe, 2" thru 12" Schedule 10S and 40S Stainless Steel and 2" thru 8" copper tube type K, L, M, and DWV.
- Pipe Lengths**
20' random schedule 40 (standard wall) to 5" groove by groove nipples. The shortest roll groove nipple capability in the industry; hands-clear operation.
- Hands Clear Grooving of Pipe and Nipples**
Enhanced operator safety provided by outboard guide roll assembly.
- Accurate, Repeatable-Groove Diameter Control**
Simplified direct action design provides positive, repeatable, control for grooving carbon and stainless piping. For grooving copper, universal diameter gauge must be utilized.
- Fast Grooving Times**
Large capacity two-stage pump. Two-stage design saves time engaging pipe while providing smooth application of optimum grooving force with reduced operator effort.
- Better Control of Pipe Flare**
Outboard guide roll assembly registers pipe for proper orientation.
- Quick, Easy Setup and Roll Change**
- Rugged Design Requires Zero Maintenance**
Sealed bearings eliminate need for periodic maintenance.
- User Friendly Design**
Pump location is adjustable for operator comfort and safety.
- Ease of Operation**
High grooving forces obtained through use of larger capability ram requires less pump effort.
- Foot Switch Power Application**
- Operator Safe Design**

- Introduction
- Couplings
- Outlets
- Fittings
- Valves & Accessories
- High Pressure
- CTS Copper System
- DI-Electric Nipples
- Plan-End Fittings
- HDPE Couplings
- Socket-Fittings
- Stainless Steel Method
- Roll Groovers
- Installation & Assembly
- Special Coatings
- Design Services
- Technical Data
- Master Format 3 Part Specs.
- Pictorial Index

Roll Groover Model 3006



Model 3006

The Gruvlok Model 3006 roll groover features a low maintenance quick roll change out design with the capability to groove 2" – 12" steel pipe, as well as 2" – 6" stainless steel. This machine is also compatible with the CTS Copper System for accurate and repeatable grooving of tube as small as 2" in diameter. Standard with each machine is the patented Gruvlok hands free nipple guide system. This one of a kind nipple guide system allows for the shortest nipple grooving in the business and is hands free for increased operator safety. A special hydraulic pump with a reduced height handle and pivoting location allow each operator to customize the machine for maximum comfort while grooving. Low cost, lightweight, user friendly, and reliable, the Model 3006 Roll Groover follows the quality Gruvlok tradition started with 1007/3007 models and takes the future of roll grooving one step further.

Gruvlok roll grooving technology is protected by U.S. Patents 5450738, 5570603, 5778715 and others pending.

- **Wide Grooving Range**
2" thru 8" Schedule 40 (standard wall) steel pipe
10" (.188" Wall)
12" (.219" wall)
2" thru 12" Sch. 10
2" thru 8" copper type K, L, M, and DWV
- **Pipe Lengths**
20' random Schedule 40 (standard wall) to 5' groove by groove nipples.
The shortest roll groove nipple capability in the industry: hands clear.
- **Hands Clear Grooving of Pipe and Nipples**
Enhanced operator safety provided by outboard guide roll assembly.
- **Accurate, Repeatable Groove Diameter Control**
Simplified direct action provided positive, repeatable control for grooving carbon and stainless piping.
For grooving copper, universal diameter gauge must be utilized.
- **Better Control of Pipe Flare**
Outboard guide roll assembly registers pipe for proper orientation.
- **Quick, Easy Setup and Roll Change**
- **Rugged Design Requires Minimal Maintenance**
Only periodic application of grease via grease fittings required.
- **User Friendly Design**
Pump has a special reduced height handle and adjustable location for operator comfort and safety.
- **Ease of Operation**
High grooving forces obtained though use of large capacity ram requires less pump effort.

Roll Groover Model 3006

Technical Data

Standard Equipment

Roll Groover complete with Adjustable Support Leg Assembly and roller sets for grooving 2"-6" and 8"-12" steel pipe, Steel/CTS Dual Guide Roll Assembly, hydraulic pump with pressure gauge, and two depth adjustment gauges. This unit is designed for direct attachment to your Ridgid® 300 Power Drive. Complete with comprehensive setup, operating and troubleshooting instructions.

- Shipped in a reusable wooden storage crate.
- Approximate shipping weight: 225 pounds.
- Required Ridgid 300 Power Drive not included.

Optional Equipment

Advanced Copper Method (IPS Copper) Option:

- Consisting of 2"-6" Advanced Copper Method roll set, Advanced Copper Method Guide Roll Assembly, and a 2"-6" Universal Diameter Gauge.
- 2"-6" Universal Diameter Gauge.

CTS Copper System Option:

- Consisting of 2"-8" roll set, 2"-6" CTS Depth Gauge, and 8" CTS Depth Gauge.

Groover Capability

Pipe Material	Pipe Size/Wall Thickness (Schedule) ^{1,2}										
	2	2½	3	4	5	6	8	10	12		
In. DN(mm)	50	65	80	100	125	150	200	250	300		
Steel	Schedule 10, 40							0.188"	0.219"		
Stainless Steel	Steel Schedule 10S, 40S							n/a	n/a	n/a	
CTS Copper System	K, L, M & DWV							n/a	n/a		

Note:

1. All wall thickness shown are the maximum wall thickness for the indicated pipe material.
2. Minimum wall thickness for each pipe materials and size is:
3. Contact an ASC Engineered Solutions™ Representative for more information on grooving alternate materials & wall thickness.

Steel: All Sizes — Sch. 10
 Stainless Steel: 2"-6" — Sch. 10S, 40S
 Copper: 2", 2½" — Type M
 3"-8" — Type DWV

Steel Pipe Grooving Times (Min: Sec.)

Pipe Size (In./DN(mm))/Max Steel Pipe Wall Thickness							
2	2½	3	4	6	8	10	12
50	65	80	100	150	200	250	300
0:20	0:20	0:25	0:30	1:20	1:55	1:40	1:20

Grooving Times:

This chart shows approximate grooving times with the groover set-up for the proper size and groove diameter and the pipe properly positioned on the groover. The times shown are average times from the start of rotation of the pipe in the grooving rolls to completed groove.

- Introduction
- Couplings
- Outlets
- Fittings
- Valves & Accessories
- High Pressure
- CTS Copper System
- D-Electric Nipples
- Plan-End Fittings
- HDPE Couplings
- Socket-Fittings
- Stainless Steel Method
- Roll Groovers
- Installation & Assembly
- Special Coatings
- Design Services
- Technical Data
- Master Format 3 Part Specs.
- Pictorial Index

NAP® Shop-Gruv™ Automated Roll Groover



Introducing ASC Engineered Solutions™ NAP® brand Shop-Gruv. Shop-Gruv is the first shop-grade automated grooving machine of its kind. With three built-in roll sets and the ability to change roll sets in seconds, the Shop-Gruv eliminates up to 95% of changeover time compared to other groovers. Designed to maximize operator safety and efficiency, Shop-Gruv grooves from the bottom which eliminates pipe stand adjustments and unnecessary pipe handling. The servo-motor driven system is the most accurate and consistent groover available today.

Features & Benefit

- **Indexing, multi-head design** Allows for quick transitions between pipe sizes, leading to **95% less roll-set changes** and driving lean processes and material flow
- **Touch screen** – Enables simple, **intuitive machine operation** and a clean interface
- **Pipe Groover** – Underside maintains a **constant pipe height without stand adjustments**
- **PLC / Servo Motor Operation** Enables accurate and **consistent / repeatable grooving**
- **Redundant safety systems** Provides **constant safety assurance** for operators and bystanders

For more information about the NAP Shop-Gruv, speak with an ASC Engineered Solutions representative.



Coupling Installation & Assembly



Installation & Assembly Table of Contents

Fig. 7401 Rigidlok® Coupling	345
Fig. 74 SlideLOK® Ready for Installation Coupling Installation and Re-Installation	346-347
Fig 70 SlideFLEX® Flexible Coupling Installation and Re-Installation	348-349
Fig. 7001 Flexible Coupling	350
Fig. 7001-2 & Fig. 7401-2 Two-Piece Large Dia. Couplings.....	351-352
Fig. 7011 Standard Coupling	353
Fig. 7000 Lightweight Flexible Coupling	354
Fig. 7400 Rigidlite® Coupling	355
Fig. 64 CTS SlideLOK® Rigid Coupling Installation and Re-Installation	356-357
Fig. 617 Transition Coupling for joining IPS to Copper Tubing Systems.....	358
Fig. 7003 Hingelok™ Coupling.....	359
Fig. 7010 Reducing Coupling	360
Fig. 7012 Gruvlok Flange (2"-12").....	361-362
Fig. 7012 Gruvlok Flange (14"-24").....	363
Fig. 7042 Outlet Coupling.....	364
Fig. 7045 & Fig.7046 Clamp-T® Branch Outlets.....	365
Fig. 7043 Branch Outlet.....	366
Fig. 7005 Roughneck® Coupling.....	367
Fig. 7004 High Pressure Coupling.....	368
Fig. 7004 High Pressure Coupling with EG Gasket	369
Fig. 7377 Double Groove Coupling	370
Fig. 7305 HDPE Coupling	371
Fig. 7307 HDPE Transition Coupling.....	372
Fig. 7312 HDPE Flange Adapter	373
Gruvlok Sock-It® Fitting	374
Model FTV Tri-Service Valve	375-377
Model 4 Circuit Balancing Valves.....	378
Fig. AnvilFlex® AF21-GG, -GF & -FF Flex Connectors.....	379

The instructions are based on pipe grooved in accordance with Gruvlok® grooving specifications. Check pipe ends for proper groove dimensions and assure that the pipe ends are free of indentations and projections which would prevent proper sealing.

ALWAYS USE A GRUVLOK® LUBRICANT FOR PROPER COUPLING ASSEMBLY. Thorough lubrication of the external surface of the gasket is essential to prevent pinching and possible damage to the gasket. For temperatures above 150° F (65.6° C) use Gruvlok Xtreme™ Lubricant and lubricate all gasket surfaces, internal and external. See Gruvlok Lubricants in the Technical Data section of the Gruvlok catalog for additional important information.

Specified Bolt Torque

Specified bolt torque is for the oval neck track bolts used on Gruvlok® couplings and flanges. The nuts must be tightened alternately and evenly until fully tightened.

CAUTION: Proper torquing of coupling bolts is required to obtain specified performance. Over torquing the bolts may result in damage to the bolt and/or casting which could result in pipe joint separation. Under torquing the bolts may result in lower pressure retention capabilities, lower bend load capabilities, joint leakage and pipe joint separation. Pipe joint separation may result in significant property damage and serious injury.

ANSI Specified Bolt Torque

Bolt Size	Wrench Size	Specified Bolt Torque *
In.	In.	Ft.-Lbs
3/8	11/16	30-45
1/2	7/8	80-100
5/8	1 1/16	100-130
3/4	1 1/4	130-180
7/8	1 7/16	180-220
1	1 5/8	200-250
1 1/8	1 13/16	225-275
1 1/4	2	250-300

* Non-lubricated bolt torques.

Metric Specified Bolt Torque

Bolt Size	Wrench Size	Specified Bolt Torque *
mm	mm	N-m
M10	16	40-60
M12	22	110-150
M16	24	135-175
M20	30	175-245
M22	34	245-300
M24	36	270-340

* Non-lubricated bolt torques.

Note:

Specified torques are to be used unless otherwise noted on Product Installation Instructions.

Maximum Working Pressure Rating is for schedule 40 steel pipe. For light wall, stainless steel, aluminum and ISO pipe pressure ratings, please refer to the technical data section.

Fig. 7401 Rigidlok® Coupling



Read and understand all instructions before use.

WARNING

Ensure system is drained and depressurized before installation or service.

Use appropriate personal protective equipment.



Failure to follow these instructions could result in serious personal injury and/or property damage.

Check pipe ends for proper grooved dimensions and to ensure that the pipe is free of indentations, projections, or other imperfections that would prevent proper sealing of the gasket.

1 Check & Lubricate Gasket

Check gasket to be sure it is compatible for the intended service. Apply a thin coating of Gruvlok lubricant to the exterior surface and sealing lips of the gasket. Some applications require lubrication of the entire gasket surface. Be careful that foreign particles do not adhere to lubricated surfaces.



Notice: Gruvlok Xtreme Lubricant must be applied when used in dry pipe systems or freezer applications. Pipe joint separation may result in significant property damage and serious injury.

2 Gasket Installation

Slip the gasket over the pipe end making sure the gasket lip does not overhang the pipe end.

On couplings 10" and larger it may be easier to turn the gasket inside out then lubricate and slide the gasket over the pipe end as shown.

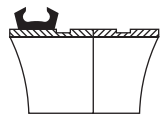

3 Alignment

After aligning the two pipe ends, pull the gasket into position centering it between the grooves on each pipe. Gasket should not extend into the groove on either pipe.

On couplings 10" and larger, flip or roll the gasket into centered position.

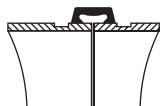

4 Housings

Remove one nut and bolt and loosen the other nut. Place one housing over the gasket, making sure the housing keys fit into the pipe grooves. Swing the other housing over the gasket and into the grooves on both pipes, making sure the tongue and recess of each housing is properly mated. Reinsert the bolt and run-up both nuts finger tight.



5 Tighten Nuts

Securely tighten nuts alternately and equally, keeping the gaps at the bolt pads evenly spaced.

Notice: Uneven tightening may cause the gasket to pinch. Gasket should not be visible between segments after bolts are tightened.

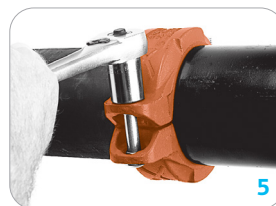

ANSI Specified Bolt Torque		
Bolt Size	Wrench Size	Specified Bolt Torque*
In.	In.	Ft.-Lbs
3/8	11/16	30-45
1/2	7/8	80-100
5/8	1 1/16	100-130
3/4	1 1/4	130-180
1	1 5/8	200-250

* Non-lubricated bolt torques.

6 Assembly is Complete

Visually inspect the pipe joint to assure the coupling keys are fully engaged in the pipe grooves. The bolt pads are to have equal gaps on each side of the coupling.

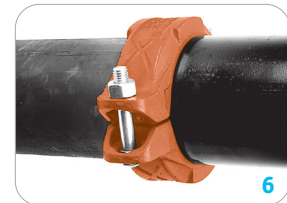

Notice: Visually inspect both sides of the coupling to ensure gaps between bolt pads are evenly spaced and are parallel. Any deviations must be corrected before placing coupling into service.

Notice: Sizes 16" and larger are cast in multiple segments. To install the larger sizes align the tongue and pocket of the couplings appropriately and tighten the nuts alternately to the specified bolt torque. When properly assembled there will be a small equal gap between the adjacent bolt pads.

Fig. 74 SlideLOK® Ready for Installation Coupling



Read and understand all instructions before use.

WARNING

Ensure system is drained and depressurized before installation or service.

Use appropriate personal protective equipment.



Failure to follow these instructions could result in serious personal injury and/or property damage.

READY FOR INSTALLATION – RIGHT OUT OF THE BOX

Do not disassemble the SlideLOK Coupling. The Figure 74 coupling is ready for installation. The bolt and gasket do not need to be removed.

1 Pipe Preparation

Pipe ends are to be rolled or cut grooved according to ASC Engineered Solutions™ specifications. Not for use on “EG” rolled or cut grooved pipe ends. The pipe end must be smooth and free from metal burrs, sharp edges or projections.

2 Gasket Preparation

Ensure the gasket is suitable for the intended application by referring to the ASC gasket compatibility chart. Apply a light coating of Gruvlok® Lubricant to exposed gasket surfaces.

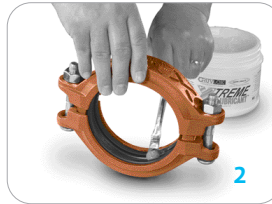

3 Assembly

The SlideLOK Figure 74 may be installed by one of two methods. The preferred method depends on the type of pipe components being joined and their orientation. Please review both methods before installing.

Step 3 – Method No. 1

Slide the SlideLOK coupling completely over the grooved pipe end. This will allow a clear and un-obstructed view of the pipe for correct alignment.

A. Slide the coupling on the pipe past the groove. The bolts and nuts can be hand tightened to position the coupling in place.

B. Align the mating pipe end. Align the two adjoining pipes together.

C. Slide the coupling back over the grooves so that the coupling keys are located over the respective grooves on both pipe ends.

D. Follow the instructions on fastening the coupling as shown in Step 4.

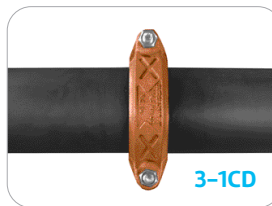

Step 3 – Method No. 2

Slide the SlideLOK coupling half way onto the pipe end or fitting. This will better accommodate fitting and valve accessories during installation.

A. Slide the coupling on the fitting so that the groove and keys are aligned.

B. Bring the pipe end or fitting towards the coupling and insert so that the groove and coupling keys are aligned.

C. Hand tighten the nuts to correctly position the couplings keys over the respective grooved ends.

D. Follow the instructions on fastening the coupling as shown in Step 4.

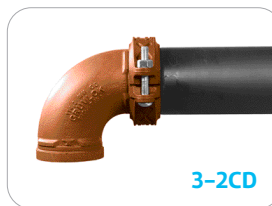

4 Tighten Nuts

Securely tighten nuts alternately and equally, keeping the gaps at the bolt pads evenly spaced.

Notice: Uneven tightening may cause the gasket to pinch. Gasket should not be visible between segments after bolts are tightened.

Maximum Bolt Torque

Bolt Size (In.)	Wrench Size (In.)	Ft-Lbs
1/2	7/8	120
5/8	1 1/16	235
3/4	1 1/2	425

WARNING

Proper tightening of coupling bolts is required to obtain specific performance. Over tightening the bolts may result in joint damage. Pipe joint separation may result in significant property damage and serious injury.



5 Assembly is Complete

Visually inspect the pipe joint to assure the coupling keys are fully engaged in the pipe grooves. The bolt pads are to have equal gaps on each side of the coupling.

Notice: Visually inspect both sides of the coupling to ensure gaps between bolt pads are evenly spaced and are parallel. Any deviations must be corrected before placing coupling into service.

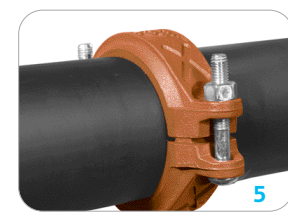
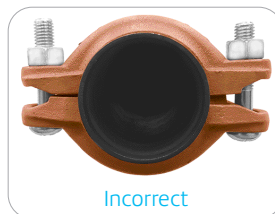
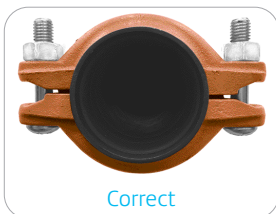

Fig. 74 SlideLOK® Ready for Installation Coupling Re-Installation



Read and understand all instructions before use.

WARNING

Ensure system is drained and depressurized before installation or service.

Use appropriate personal protective equipment.



Failure to follow these instructions could result in serious personal injury and/or property damage.

REINSTALLATION OF THE FIGURE 74 SLIDELOK COUPLING

The SlideLOK coupling is designed to be installed in the ready for installation assembly position once. After the initial assemble the following steps are to be taken to re-install the Fig. 74 SlideLOK coupling.

1 De-Pressurize the System

De-pressurize the system before removing the SlideLOK Coupling. Dis-assemble the couplings by removing the nuts, bolts and gasket from the housing halves. A wrench is required to overcome the epoxy used to secure the nuts on the bolts.

2 Pipe Preparation

Pipe ends are to be rolled or cut grooved according to ASC Engineered Solutions™ specifications. Not for use on "EG" rolled or cut grooved pipe ends. The pipe end must be smooth and free from metal burrs, sharp edges or projections.

3 Gasket Preparation

Ensure the gasket is suitable for the intended application by referring to the Anvil gasket compatibility chart. A light coating of Gruvlok® lubricant must be applied to the gasket prior to installation.



4 Pipe Alignment and Gasket Installation

Slide the gasket onto the pipe then align the two pipe ends together. Pull the gasket into position, centering it between the grooves on each pipe. Gasket should not extend into the groove on either pipe.



5 Housing Assembly

Place each housing halves on the pipe making sure the housing key fits into the groove. Be sure that the tongue and recess portions of the housing mate properly. Insert the bolts.

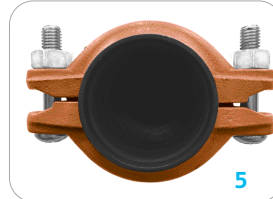

6 Tighten Nuts

Securely tighten nuts alternately and equally, keeping the gaps at the bolt pads evenly spaced.

Maximum Bolt Torque

Bolt Size (In.)	Wrench Size (In.)	Ft.-Lbs
1/2	7/8	120
5/8	1 1/16	235
3/4	1 1/2	425

Notice: Uneven tightening may cause the gasket to pinch. Gasket should not be visible between segments after bolts are tightened.

WARNING:

Proper tightening of coupling bolts is required to obtain specified performance. Over tightening the bolts may result in joint damage. Pipe joint separation may result in significant property damage and serious injury.

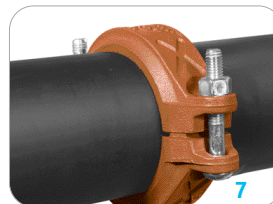

7 Assembly is Complete

Visually inspect the pipe joint to assure the coupling keys are fully engaged in the pipe grooves. The bolt pads are to have equal gaps on each side of the coupling.

Notice: Visually inspect both sides of the coupling to ensure gaps between bolt pads are evenly spaced and are parallel. Any deviations must be corrected before placing coupling into service.

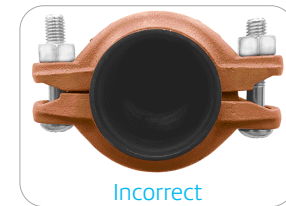
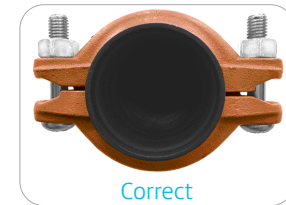

Fig. 70 SlideFLEX™ Ready for Installation Flexible Coupling Installation



Read and understand all instructions before use.

WARNING

Ensure system is drained and depressurized before installation or service.

Use appropriate personal protective equipment.



Failure to follow these instructions could result in serious personal injury and/or property damage.

1 Pipe Preparation

Pipe ends are to be rolled or cut grooved according to ASC Engineered Solutions™ specifications. Not for use on “EG” rolled or cut grooved pipe ends. The pipe end must be smooth and free from metal burrs, sharp edges or projections.

2 Gasket Preparation

Ensure the gasket is suitable for the intended application by referring to the ASC gasket compatibility chart. Apply a light coating of Gruvlok® Lubricant to exposed gasket surfaces.

3 Assembly

Slide the coupling on pipe or fitting. The bolts and nuts can be hand tightened to limit coupling movement during the next steps.

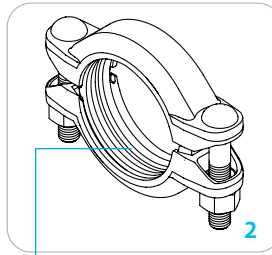
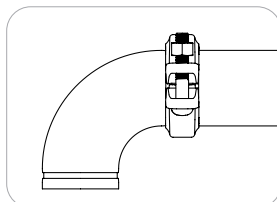
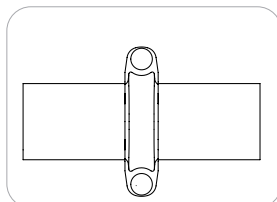
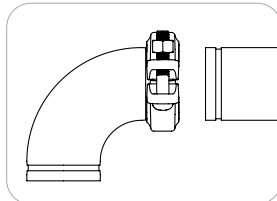
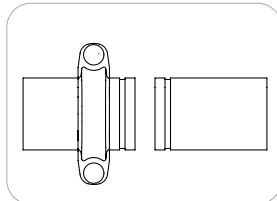
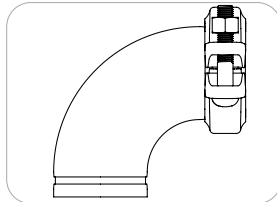
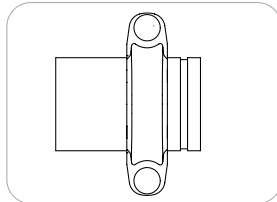

Apply thin coat of lubricant. Keep foreign particles from adhering.

Bring ends of adjoining pipes or fittings together.

Adjust coupling to ensure all grooves and couplings keys are aligned.

5 Assembly is Complete

Visually inspect the pipe joint to ensure the coupling keys are fully engaged in the pipe grooves. The bolt pads are to have metal-to-metal contact on each side of the coupling.

NOTICE: Visually inspect both sides of the coupling to ensure there are no gaps between bolt pads. Any deviations must be corrected before placing coupling into service.

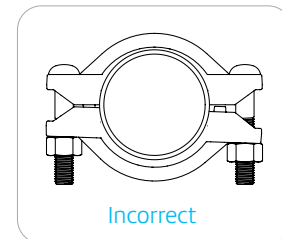
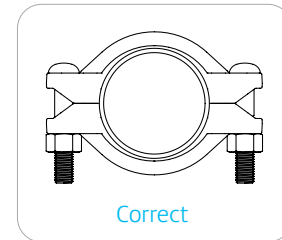

4 Tighten Nuts

Securely tighten nuts alternately and equally until the bolt pads make metal-to-metal contact.

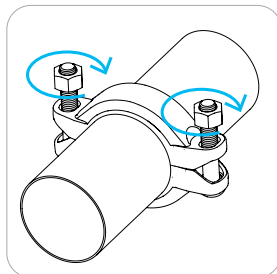

NOTICE: Uneven tightening may cause gasket to pinch. Gasket should not be visible between segments after bolts are tightened.

Fig. 70 SlideFLEX™ Ready for Installation Flexible Coupling Re-Installation



Read and understand all instructions before use.

WARNING

Ensure system is drained and depressurized before installation or service.

Use appropriate personal protective equipment.



Failure to follow these instructions could result in serious personal injury and/or property damage.

REINSTALLATION OF THE FIGURE 70 SLIDEFLEX COUPLING

The SlideFLEX coupling is designed to be installed in the ready for installation assembly position once. After the initial assemble the following steps are to be taken to re-install the Fig. 70 SlideFLEX coupling.

1 De-Pressurize the System

De-pressurize the system before removing the SlideLOK Coupling. Dis-assemble the couplings by removing the nuts, bolts and gasket from the housing halves. A wrench is required to overcome the epoxy used to secure the nuts on the bolts.

2 Pipe Preparation

Pipe ends are to be rolled or cut grooved according to ASC Engineered Solutions™ specifications. Not for use on "EG" rolled or cut grooved pipe ends. The pipe end must be smooth and free from metal burrs, sharp edges or projections.

3 Gasket Preparation

Ensure the gasket is suitable for the intended application by referring to the Anvil gasket compatibility chart. A light coating of Gruvlok® lubricant must be applied to the gasket prior to installation.

Apply thin coat of lubricant Keep foreign particles from adhering.

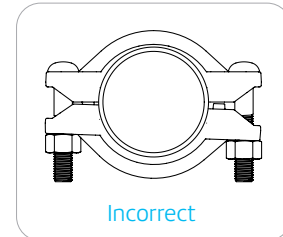
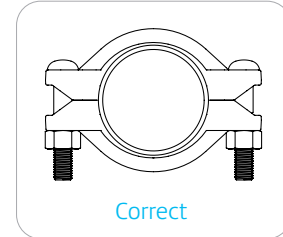
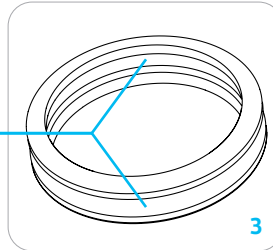

4 Pipe Alignment & Gasket Installation

Slide the gasket onto the pipe then align the two pipe ends together. Pull the gasket into position, centering it between the grooves on each pipe. Gasket should not extend into the groove on either pipe.

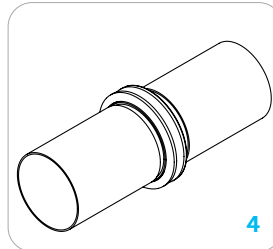

5 Housing Assembly

Place each housing halves on the pipe making sure the housing key fits into the groove. Be sure that the tongue and recess portions of the housing mate properly. Insert the bolts.

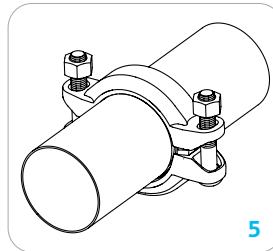

6 Tighten Nuts

Securely tighten nuts alternately and equally until the bolt pads make metal-to-metal contact.

NOTICE: Uneven tightening may cause gasket to pinch. Gasket should not be visible between segments after bolts are tightened.

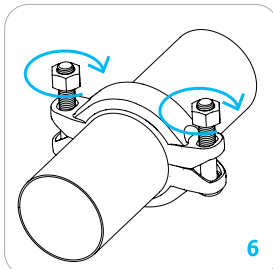

7 Assembly is Complete

Visually inspect the pipe joint to ensure the coupling keys are fully engaged in the pipe grooves. The bolt pads are to have metal-to-metal contact on each side of the coupling.

NOTICE: Visually inspect both sides of the coupling to ensure there are no gaps between bolt pads. Any deviations must be corrected before placing coupling into service.

Fig. 7001 Flexible Coupling

1 Check & Lubricate Gasket

Check gasket to be sure it is compatible for the intended service. Apply a thin coating of Gruvlok® lubricant to the exterior surface and sealing lips of the gasket. Be careful that foreign particles do not adhere to lubricated surfaces.



2 Gasket Installation

Slip the gasket over the pipe end making sure the gasket lip does not overhang the pipe end.

On couplings 10" and larger it may be easier to turn the gasket inside out then lubricate and slide the gasket over the pipe end as shown.

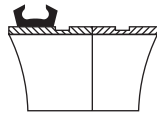

3 Alignment

After aligning the two pipe ends, pull the gasket into position centering it between the grooves on each pipe. Gasket should not extend into the groove on either pipe.

On couplings 10" and larger, flip or roll the gasket into centered position.

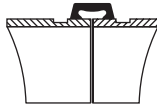

4 Housings

Place the coupling housing halves over the gasket making sure the housing keys engage the grooves. Insert bolts and turn nuts finger tight.



5 Tighten Nuts

Tighten the nuts alternately and equally to the specified bolt torque. The housing bolt pads must make metal-to-metal contact.

CAUTION: Uneven tightening may cause the gasket to pinch.



6 Assembly is Complete

Visually inspect the pipe joint to assure the coupling keys are fully engaged in the pipe grooves and the bolt pads are in firm even metal-to-metal contact on both sides of the coupling.



Note: The housings for sizes 16" and larger are cast in four or more segments.

To Install: Loosely pre-assemble the segments into two "Housing Halves" making sure that the alignment tang(s) and slot(s) on the bolt pad(s) are properly mated. Install the "Housing Halves" as shown in steps 4 & 5. The coupling is properly installed when all bolt pads are firmly together - Metal-to-Metal.

CAUTION: Proper torquing of coupling bolts is required to obtain specified performance. Over torquing the bolts may result in damage to the bolt and/or casting which could result in pipe joint separation. Under torquing the bolts may result in lower pressure retention capabilities, lower bend load capabilities, joint leakage and pipe joint separation. Pipe joint separation may result in significant property damage and serious injury.

- Introduction
- Couplings
- Outlets
- Fittings
- Valves & Accessories
- High Pressure
- CTS Copper System
- DI-Electric Nipples
- Plan-End Fittings
- HDPE Couplings
- Socket-Fittings
- Stainless Steel Method
- Roll Groovers
- Installation & Assembly
- Special Coatings
- Design Services
- Technical Data
- Master Format 3 Part Specs.
- Pictorial Index

Fig. 7001-2 Two-Piece Large Diameter Couplings



Read and understand all instructions before use.

WARNING

Ensure system is drained and depressurized before installation or service.

Use appropriate personal protective equipment.



Failure to follow these instructions could result in serious personal injury and/or property damage.

Pipe Preparation

Check pipe ends for proper grooved dimensions and to ensure that the pipe is free of indentations, projections, or other imperfections that would prevent proper sealing of the gasket.

- 7001-2 bolts must be lightly coated with Gruvlok Xtreme lube before installation. See chart for torque requirements.
- Minimum wall pipe suitable for 14" – 24": 7001-2 roll grooved installation is 0.250" wall thickness.
- Pipe preparation grooved dimensions must conform to the Gruvlok Roll/Cut groove specification.

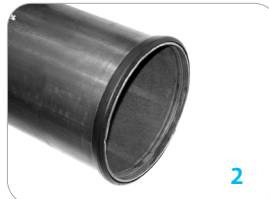

1 Check & Lubricate Gasket

Check gasket to be sure it is compatible for the intended service. Apply a thin coat of Gruvlok lubricant to the exterior surface and sealing lips of the gasket. Be careful that foreign particles do not adhere to lubricated surfaces.

2 Gasket Installation

Slip the gasket over the pipe end, making sure the gasket lip does not overhang the pipe end.

3 Alignment

After aligning the two pipe ends together, pull the gasket into position, centering it between the grooves on each pipe. Gasket should not extend into the groove on either pipe.

4 Housing

Place each housing half on the pipe and into each groove making sure that the gasket does not slip out of position in between the pipe ends or groove.

5 Bolts

Apply a thin coat of Xtreme lube to the bolt threads. Tighten the nuts alternately and equally to the specified bolt torque.

NOTICE: Uneven tightening may cause the gasket to pinch. Gasket should not be visible between segments after bolts are tightened.

ANSI Specified Bolt Torque

Pipe Sizes	Bolt Size	Specified Bolt Torque	Lubrication
In.	In.	Ft.-Lbs	
14	7/8	180–220	
16	1	250–300	
18	1	250–300	Gruvlok Xtreme Lubricant
20	1 1/8	375–425	
24	1 1/8	375–425	

6 Final Assembly

Visually inspect the pipe joint to assure the coupling keys are fully engaged in the pipe grooves, the bolt pads are in firm even metal-to-metal contact on both sides of the coupling, and gasket is not visible.

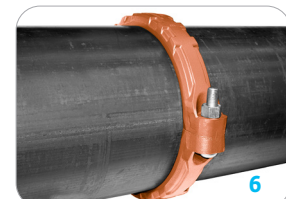

Fig. 7401-2 Two-Piece Large Diameter Groove Couplings



Read and understand all instructions before use.

WARNING

Ensure system is drained and depressurized before installation or service.

Use appropriate personal protective equipment.



Failure to follow these instructions could result in serious personal injury and/or property damage.

Pipe Preparation

Check Pipe ends for proper grooved dimensions and to ensure that the pipe is free of indentations, projections, or other imperfections that would prevent proper sealing of the gasket.

- 7401-2 bolts must be lightly coated with Gruvlok Xtreme lube before installation. See chart for torque requirements.
- Minimum wall pipe suitable for 14" – 24": 7401-2 roll grooved installation is 0.250" wall thickness.
- Pipe preparation grooved dimensions must conform to the Gruvlok Roll/Cut groove specification.

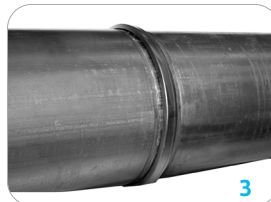
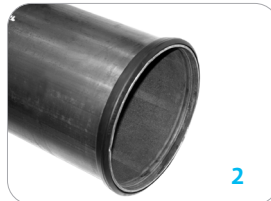

ANSI Specified Bolt Torque

Pipe Size	Bolt Size	Specified Bolt Torque	Lubrication
In.	In.	Ft.-Lbs	
14	7/8	180-220	Gruvlok Xtreme Lubricant
16	1	250-300	
18	1	250-300	
20	1 1/8	375-425	
24	1 1/8	375-425	

1a Check & Lubricate Gasket

Check gasket to be sure it is compatible for the intended service. Apply a thin coat of Gruvlok lubricant to the exterior surface and sealing lips of the gasket. Be careful that foreign particles do not adhere to lubricated surfaces.

2 Gasket Installation

Slip the gasket over the pipe end, making sure the gasket lip does not overhang the pipe end.

3 Alignment

After aligning the two pipe ends together, pull the gasket into position, centering it between the grooves on each pipe. Gasket should not extend into the groove on either pipe.

4 Housing

Place each housing half on the pipe and into each groove making sure that the gasket does not slip out of position in between the pipe ends or groove.

5 Bolts

Apply a thin coat of Xtreme lube to the bolt threads. Tighten the nuts alternately and equally to the specified bolt torque.

NOTICE: Uneven tightening may cause the gasket to pinch. Gasket should not be visible between segments after bolts are tightened.

6 Final Assembly

Visually inspect the pipe joint to assure the coupling keys are fully engaged in the pipe grooves, the bolt pads are in firm even metal-to-metal contact on both sides of the coupling, and gasket is not visible.

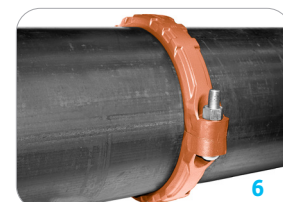

Fig. 7011 Standard Coupling



Read and understand all instructions before use.

WARNING

Ensure system is drained and depressurized before installation or service.

Use appropriate personal protective equipment.



Failure to follow these instructions could result in serious personal injury and/or property damage.

1 Pipe Preparation

Inspect the pipe ends making sure the criteria, in the Gruvlok Large Diameter Pipe Roll and Cut Groove specifications, are met.

2 Gasket Installation

Turn the gasket inside out and slide the gasket completely over one of the pipe ends. Turning the gasket inside out will reduce the stretching necessary to put the gasket into position. Ideally, approximately 75% of the pipe's gasket-sealing surface, (Dimension A) should be visible when the gasket is in proper position. This will aid in step 4.

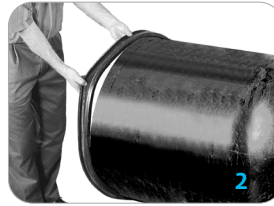

3 Lubricate Gasket

Lubricate the gasket sealing lips. The use of Gruvlok lubricants ensures compatibility between the lubricant and the gasket.



4 Alignment

Pull the two pipes into contact aligning the pipe ends.

CAUTION: Be careful not to pinch fingers during this step. Working your way around the circumference of the pipe, flip the gasket toward the pipe end so that the proper side is facing out. The end of this procedure will result in the gasket snapping into place. Position the gasket centrally between the grooves of the two pipe ends.



5 Lubricate Gasket

Lubricate the exterior surface of the gasket. This helps prevent pinching of the gasket during assembly.



6 Housings

Secure the housings about the pipes making sure the coupling keys are engaged in the pipe end grooves. Hint: For horizontal assembly, place housing segment on top of the pipe to support the weight of the housing segment. Secure the adjacent housing with an oval neck track bolt and heavy hex nut and then rotate the secured housings, again balancing the weight of the housings on the top of the pipe. Continue this procedure for all segments.



7 Tighten Nuts

Firmly torque each bolt. The specified minimum torque for each nut is 600 ft.-lbs. The specified maximum torque for each nut is 800 ft.-lbs.



8 Assembly is Complete

Installation of the Figure 7011 Standard Coupling is completed.



CAUTION: Proper torquing of coupling bolts is required to obtain specified performance. Over torquing the bolts may result in damage to the bolt and/or casting which could result in pipe joint separation. Under torquing the bolts may result in lower pressure retention capabilities, lower bend load capabilities, joint leakage and pipe joint separation. Pipe joint separation may result in significant property damage and serious injury.

Fig. 7000 Lightweight Flexible Coupling

1 Check & Lubricate Gasket

Check gasket to be sure it is compatible for the intended service. Apply a thin coating of Gruvlok lubricant to the exterior surface and sealing lips of the gasket. Be careful that foreign particles do not adhere to lubricated surfaces.



2 Gasket Installation

Slip the gasket over the pipe end, making sure the gasket lip does not overhang the pipe end.



3 Alignment

After aligning the two pipe ends together, pull the gasket into position, centering it between the grooves on each pipe. Gasket should not extend into the groove on either pipe.



4 Housings

With one nut unthreaded to the end of the bolt, unthread the other nut completely and swing the coupling housing halves over the gasket, making sure the housing keys engage the grooves. Insert the bolt and turn the nuts finger tight.

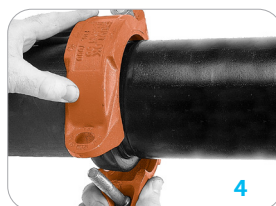

5 Tighten Nuts

Tighten the nuts alternately and equally to the specified bolt torque. The housing bolt pads must make metal-to-metal contact.

CAUTION: Uneven tightening may cause the gasket to pinch.

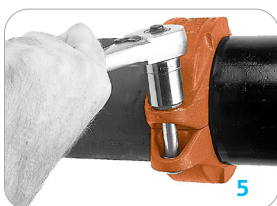

6 Assembly is Complete

Visually inspect the pipe joint to assure the coupling keys are fully engaged in the pipe grooves and the bolt pads are in firm even metal-to-metal contact on both sides of the coupling.

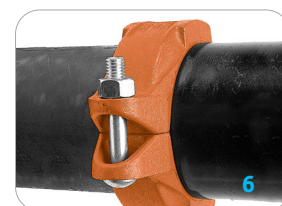

Caution: Proper torquing of coupling bolts is required to obtain specified performance. Over torquing the bolts may result in damage to the bolt and/or casting which could result in pipe joint separation. Under torquing the bolts may result in lower pressure retention capabilities, lower bend load capabilities, joint leakage and pipe joint separation. Pipe joint separation may result in significant property damage and serious injury.

- Introduction
- Couplings
- Outlets
- Fittings
- Valves & Accessories
- High Pressure
- CTS Copper System
- DI-Electric Nipples
- Plan-End Fittings
- HDPE Couplings
- Socket-Fittings
- Stainless Steel Method
- Roll Groovers
- Installation & Assembly
- Special Coatings
- Design Services
- Technical Data
- Master Format 3 Part Specs.
- Pictorial Index

Fig. 7400 Rigidlite® Coupling



Read and understand all instructions before use.

WARNING

Ensure system is drained and depressurized before installation or service.

Use appropriate personal protective equipment.



Failure to follow these instructions could result in serious personal injury and/or property damage.

Check pipe ends for proper grooved dimensions and to ensure that the pipe is free of indentations, projections, or other imperfections that would prevent proper sealing of the gasket.

1 Check & Lubricate Gasket

Check gasket to be sure it is compatible for the intended service. Apply a thin coating of Gruvlok lubricant to the exterior surface and sealing lips of the gasket. Some applications require lubrication of the entire gasket surface. Be careful that foreign particles do not adhere to lubricated surfaces.

Notice: Gruvlok Xtreme Lubricant must be applied when used in dry pipe systems or freezer applications. separation. Pipe joint separation may result in significant property damage and serious injury.



2 Gasket Installation

Slip the gasket over the pipe end making sure the gasket lip does not overhang the pipe end.

On couplings 10" and larger it may be easier to turn the gasket inside out then lubricate and slide the gasket over the pipe end as shown.

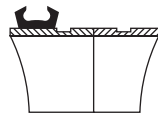

3 Alignment

After aligning the two pipe ends, pull the gasket into position centering it between the grooves on each pipe. Gasket should not extend into the groove on either pipe.

On couplings 10" and larger, flip or roll the gasket into centered position.

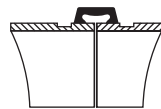

4 Housings

Remove one nut and bolt and loosen the other nut. Place one housing over the gasket, making sure the housing keys fit into the pipe grooves. Swing the other housing over the gasket and into the grooves on both pipes, making sure the tongue and recess of each housing is properly mated. Reinsert the bolt and run-up both nuts finger tight.



ANSI Specified Bolt Torque

Bolt Size	Wrench Size	Specified Bolt Torque*
In.	In.	Ft.-Lbs
3/8	11/16	30-45
1/2	7/8	80-100

* Non-lubricated bolt torques.

5 Tighten Nuts

Securely tighten nuts alternately and equally, keeping the gaps at the bolt pads evenly spaced.

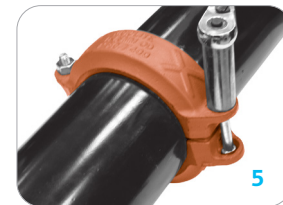

Notice: Uneven tightening may cause the gasket to pinch. Gasket should not be visible between segments after bolts are tightened.

6 Assembly is Complete

Visually inspect the pipe joint to assure the coupling keys are fully engaged in the pipe grooves. The bolt pads are to have equal gaps on each side of the coupling.

Notice: Visually inspect both sides of the coupling to ensure gaps between bolt pads are evenly spaced and are parallel. Any deviations must be corrected before placing coupling into service.

Notice: Sizes 16" and larger are cast in multiple segments. To install the larger sizes align the tongue and pocket of the couplings appropriately and tighten the nuts alternately to the specified bolt torque. When properly assembled there will be a small equal gap between the adjacent bolt pads.

Fig. 64 CTS SlideLOK® Rigid Coupling

READY FOR INSTALLATION – RIGHT OUT OF THE BOX

Do not disassemble the CTS SlideLOK™ Coupling. The Figure 64 coupling is ready for installation. The bolt and gasket do not need to be removed.

1 Copper Tube Preparation

Copper tube ends are to be roll grooved copper tube according to ASC specifications. The tube end must be smooth and free from metal burrs or projections.

2 Gasket Preparation

Ensure the gasket is suitable for the intended application by referring to the ASC gasket compatibility chart. Apply a light coating of Gruvlok Lubricant to exposed gasket surfaces.

3 Assembly

The CTS SlideLOK Figure 64 may be installed by one of two methods. The preferred method depends on the type of components being joined and their orientation. Please review both methods before installing.

Step 3 – Method No. 1

Slide the CTS SlideLOK coupling completely over the grooved copper tube end. This will allow a clear and un-obstructed view of the tube for correct alignment.

A. Slide the coupling on the copper tube past the groove. The bolts and nuts can be hand tightened to position the coupling in place.

- B.** Align the mating copper tube end. Align the two adjoining tubes together.
- C.** Slide the coupling back over the grooves so that the coupling keys are located over the respective grooves on both copper tube ends.
- D.** Follow the instructions on fastening the coupling as shown in Step 4.



Step 3 – Method No. 2

Slide the CTS SlideLOK coupling half way onto the copper tube end or fitting. This will better accommodate fitting and valve accessories during installation.

- A.** Slide the coupling on the fitting so that the groove and keys are aligned.
- B.** Bring the copper tube end or fitting towards

- the coupling and insert so that the groove and coupling keys are aligned.
- C.** Hand tighten the nuts to correctly position the couplings keys over the respective grooved ends.
- D.** Follow the instructions on fastening the coupling as shown in Step 4.



4 Final Assembly

Securely tighten nuts alternately and equally, keeping the gaps at the bolt pads evenly spaced.

Notice: Uneven tightening may cause the gasket to pinch. Gasket should not be visible between segments after bolts are tightened.

5 Assembly is complete

Visually inspect the pipe joint to assure the coupling keys are fully engaged in the pipe grooves. The bolt pads are to have equal gaps on each side of the coupling.

ANSI Specified Bolt Torque

Size	Torque
In.	Ft.-Lbs
2	45-60
2½-4	80-100
5-8	100-130

Notice: Visually inspect both sides of the coupling to ensure gaps between bolt pads are evenly spaced and are parallel. Any deviations must be corrected before placing coupling into service.

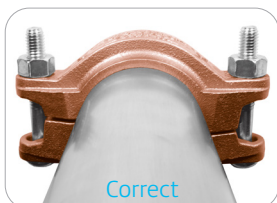
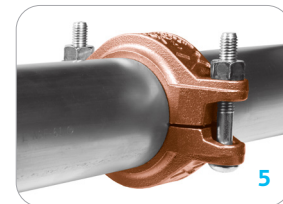

- Introduction
- Couplings
- Outlets
- Fittings
- Valves & Accessories
- High Pressure
- CTS Copper System
- DI-Electric Nipples
- Plan-End Fittings
- HDPE Couplings
- Socket-It® Fittings
- Stainless Steel Method
- Roll Groovers
- Installation & Assembly
- Special Coatings
- Design Services
- Technical Data
- Master Format 3 Part Specs.
- Pictorial Index

Fig. 64 CTS SlideLOK® Rigid Coupling

REINSTALLATION OF THE FIG. 64 CTS SLIDELOK™ COUPLING

The CTS SlideLOK coupling is designed to be installed in the ready for installation assembly position once. After the initial assemble the following steps are to be taken to re-install the Fig. 64 CTS SlideLOK coupling.

1 De-pressurize the System

De-pressurize the system before removing the CTS SlideLOK Coupling. Disassemble the couplings by removing the nuts, bolts and gasket from the housing halves. A wrench is required to overcome the epoxy used to secure the nuts on the bolts.

2 Copper Tube Preparation

Copper tube ends are to be roll grooved copper tube according to Anvil specifications. The tube end must be smooth and free from metal burrs or projections.

3 Gasket Preparation

Ensure the gasket is suitable for the intended application by referring to the ASC gasket compatibility chart. A light coating of Gruvlok lubricant must be applied to the gasket prior to installation.

4 Copper Tube Alignment and Gasket Installation

Slide the gasket onto the copper tube then align the two tube ends together. Center the gasket between the grooves on each copper tube. Gasket should not extend into the groove on either copper tube.

5 Housing Assembly

Place each of the housing halves on the copper tube making sure the housing key fits into the groove. Be sure that the tongue and recessed portions of the housings mate properly. Insert the bolts and loosely install the nuts.

6 Tighten Nuts

Securely tighten nuts alternately and equally, keeping the gaps at the bolt pads evenly spaced.

Notice: Uneven tightening may cause the gasket to pinch. Gasket should not be visible between segments after bolts are tightened.

ANSI Specified Bolt Torque

Size	Torque
In.	Ft.-Lbs
2	45-60
2½-4	80-100
5-8	100-130

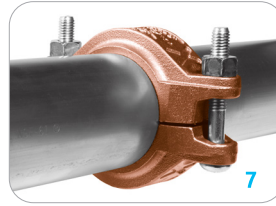
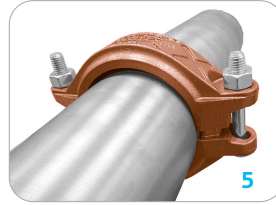
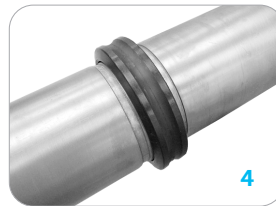

7 Assembly is complete

Visually inspect the pipe joint to assure the coupling keys are fully engaged in the pipe grooves. The bolt pads are to have equal gaps on each side of the coupling.

Notice: Visually inspect both sides of the coupling to ensure gaps between bolt pads are evenly spaced and are parallel. Any deviations must be corrected before placing coupling into service.

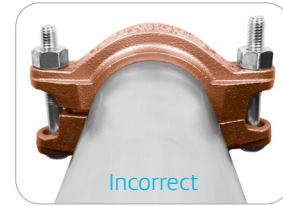
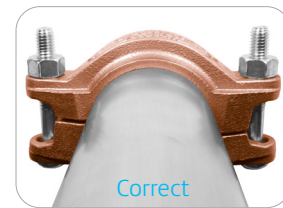

Fig. 617 Transition Coupling for Joining Stainless Steel IPS to Copper Tubing Systems



Read and understand all instructions before use.

WARNING

Ensure system is drained and depressurized before installation or service.

Use appropriate personal protective equipment.



Failure to follow these instructions could result in serious personal injury and/or property damage.

WARNING

The Gruvlok Figure 617 Transition Coupling features a tongue and groove design. The coupling must always be installed so that the tongue and groove mate properly. Attempting to install these couplings tongue to tongue or groove to groove will result in joint failure, property damage, or serious injury.

Note: The Gruvlok Figure 617 Transition Couplings should always be installed so that the coupling bolt pads make metal-to-metal contact.

As copper tubing is thinner than carbon steel pipe, always use a roll set specifically designed for use on copper tubing.

1 Copper Tube Preparation

Inspect exterior groove and ends of the pipe to verify all burrs, loose debris, dirt, chips, paint and any other foreign material, such as grease, are removed. Pipe end sealing surfaces must be free from sharp edges, projections, indentations, and/or other defects.

2 Gasket Preparation

Verify that the coupling and gasket grade are correct for the application intended.

3 Lubricate Gasket

The sealing edges and outer surfaces of the gasket should be covered with a fine layer of lubricant. To prevent deterioration of the gasket material, a petroleum lubricant should never be used on Grade "E" EPDM. For assembly below 40°F (4°C), a petroleum-free silicone lubricant must be used to prevent freezing of the lubricant.

4 Gasket Installation

Install the gasket by placing it over the end of the IPS steel tube. Ensure that the gasket is installed correctly by identifying the IPS side of the gasket labeled on the flat-face side of the gasket. Push the gasket onto the end of the IPS pipe until the IPS pipe stops at the center-stop of the gasket.

Note: To aid in a proper installation of the Transition Coupling, always install the gasket onto the IPS steel tube first.

5 Bring Pipe & Tube Ends Together

Bring both pipe ends together, ensure proper alignment, and push the CTS pipe into the gasket until the CTS pipe stops at the center-stop of the gasket. Ensure the gasket is centered between the grooved portions of each pipe.

The gasket should not protrude into the grooves on either pipe segment or extend between the pipe ends.

6 Housings

Place the Figure 617 Copper Transition Coupling over the gasket and verify that the housing keys are fully engaged into the pipe grooves.

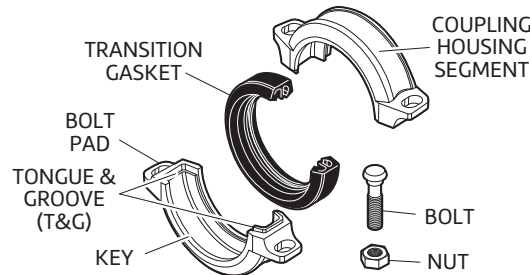

7 Bolts

Insert the bolts into the coupling and rotate the nuts until finger tight. Verify that the "track bolt heads" are fully recessed in the housing.

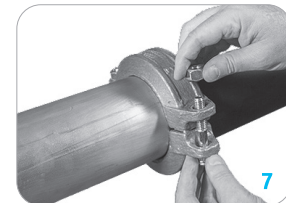

8 Tighten Nuts

Tighten nuts uniformly to the recommended bolt torque.

Always tighten the nut and bolt set evenly. Uneven tightening may cause the gasket to pinch or bind.

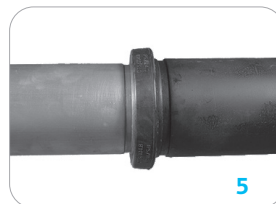
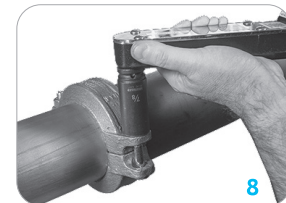

Fig. 7003 Hingelok Coupling



Read and understand all instructions before use.

WARNING

Ensure system is drained and depressurized before installation or service.

Use appropriate personal protective equipment.



Failure to follow these instructions could result in serious personal injury and/or property damage.

1 Check & Lubricate Gasket

Check gasket to be sure it is compatible for the intended service. Apply a thin coating of Gruvlok lubricant to the exterior surface and sealing lips of the gasket. Be careful that foreign particles do not adhere to lubricated surfaces.

Note: Remove locking pin from handle before opening coupling.



2 Gasket Installation

Slip the gasket over the pipe end making sure the gasket lip does not overhang the pipe end.



3 Alignment

After aligning the two pipe ends, pull the gasket into position centering it between the grooves on each pipe. Gasket should not extend into the groove on either pipe.



4 Housings

Put one half of the open coupling over the gasket as the coupling keys fit firmly into the grooves on each pipe end. Swing the other half of the coupling into position around the gasket and into the grooves.



5 Lock Coupling

Fit the nose of the locking handle in the notch of the opposite housing. Press firmly down on the handle until it makes contact with the coupling housing. Insert locking pin into handle linkage to secure handle in closed position. (See Caution.)



6 Assembly is Complete

Visually inspect the pipe joint to assure the coupling keys are fully engaged in the pipe grooves and the bolt pads are in firm even metal-to-metal contact on both sides of the coupling.

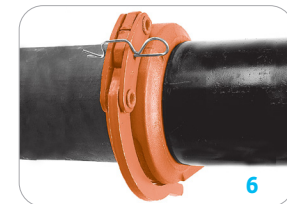

CAUTION:

- Hammering or banging on the handle or coupling housing could cause serious damage to the locking device and coupling assembly. The result may be an unsuitable pipe joint and unusable coupling assembly.
- Care needs to be taken so that fingers do not get caught or pinched when handle is placed in locked position as a result of cam action of handle assembly.
- When re-using coupling and gasket, always inspect gasket for damage and hinge/handle assembly for looseness, distortion or any other damage.

Fig. 7010 Reducing Coupling

CAUTION

Proper torquing of coupling bolts is required to obtain specified performance. Over torquing the bolts may result in damage to the bolt and/or casting which could result in pipe joint separation. Under torquing the bolts may result in lower pressure retention capabilities, lower bend load capabilities, joint leakage and pipe joint separation. Pipe joint separation may result in significant property damage and serious injury.

1 Check & Lubricate Gasket

Check gasket to be sure it is compatible for the intended service. Apply a thin coating of Gruvlok lubricant to the exterior surface and sealing lips of the gasket. Be careful that foreign particles do not adhere to lubricated surfaces.

2 Gasket Installation

Place the smaller opening of the gasket over the smaller pipe. Angle the gasket over the pipe end and pull the gasket lip open around the circumference of the pipe. The center leg of the gasket should make flush contact with the pipe end and will prevent telescoping of the smaller pipe inside the larger.

3 Alignment

Align the adjoining pipe center lines, and insert the larger pipe end into the gasket. Angle the pipe end slightly to the face of the gasket and tilt the pipe into the gasket to ease assembly.

4 Housings

Place the coupling housing halves over the gasket making sure the housing keys engage the grooves. Insert bolts and turn nuts finger tight.

5 Tighten Nuts

Tighten the nuts alternately and equally to the specified bolt torque. The housing bolt pads must make metal-to-metal contact.

Caution: Uneven tightening may cause the gasket to pinch.

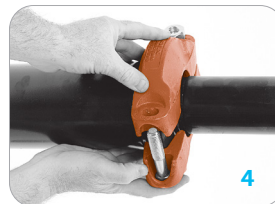

6 Assembly is Complete

Visually inspect the pipe joint to assure the coupling keys are fully engaged in the pipe grooves and the bolt pads are in firm even metal-to-metal contact on both sides of the coupling.

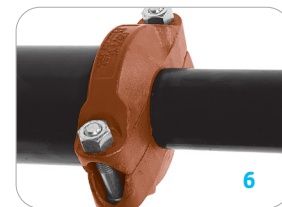
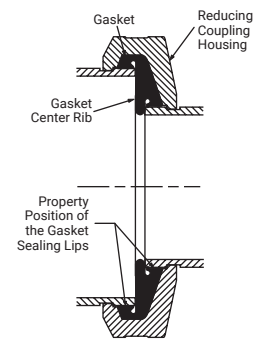

Fig. A

Note: Fig. A illustrates the correct position of the Fig. 7010 Reducing Coupling gasket and housing properly assembled onto adjacent pipe ends.



Caution:

In vertical installations the pipes must be supported to prevent telescoping during installation.

- Introduction
- Couplings
- Outlets
- Fittings
- Valves & Accessories
- High Pressure
- CTS Copper System
- DI-Electric Nipples
- Plan-End Fittings
- HDPE Couplings
- Socket-It® Fittings
- Stainless Steel Method
- Roll Groovers
- Installation & Assembly
- Special Coatings
- Design Services
- Technical Data
- Master Format 3 Part Specs.
- Pictorial Index

Fig. 7012 Gruvlok® Flange (2"-12")



Read and understand all instructions before use.

WARNING

Ensure system is drained and depressurized before installation or service.

Use appropriate personal protective equipment.



Failure to follow these instructions could result in serious personal injury and/or property damage.

WARNING

The Gruvlok Flange gasket must be inserted so that the sealing lips face toward the pipe end and the mating flange. The lip of the gasket, sealing on the pipe, should not extend beyond the pipe end. The pipe should extend out beyond the end of the sealing lip by approximately $\frac{1}{8}$ " on the 2"-6" sizes and $\frac{3}{16}$ " on the 8"-12" sizes.

Applications which require Gruvlok Flange Adapter Insert

1. When mating to a wafer valve (lug valve), if the valve is rubber faced in the area designated by the sealing surface dimensions (A Max. to B Min.), place the Gruvlok Flange Adapter Insert between the valve and the Gruvlok flange.
2. When mating to a rubber-faced metal flange, the Gruvlok Flange Adapter Insert is placed between the Gruvlok Flange and the rubber-faced flange.
3. When mating to a serrated flange surface, a standard full-faced flange gasket is installed against the serrated flange face and the Gruvlok Flange Adapter Insert is placed between the Gruvlok Flange and the standard Flange gasket.
4. When mating to valves or other component equipment where the flange face has an insert, use procedure described in note 3.

Check pipe end for proper grooved dimensions and to assure that the pipe end is free of indentations and projections that would prevent proper sealing of the Gruvlok flange gasket.

3 Check & Lubricate Gasket

Check the gasket to assure that it is properly suited for the intended service. Lubricate the entire exterior surface of the gasket, including the sealing lips, using the proper Gruvlok lubricant.



1 Install Housings

On the side without the hinge pin, loosen the latch bolt nut to the end of the bolt thread. (It is not necessary to remove the nut from the latch bolt.) Swing the latch bolt out of the slot. Open the Gruvlok Flange and place around the grooved pipe end with the key section fitting into the groove. The flange gasket cavity must face the pipe end.

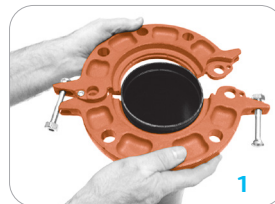

2 Latch Housings

Place the latch bolt back into the slotted hole. Tighten the nut until there is a $\frac{1}{16}$ " gap between the flange halves at location "A". (See Figure below)

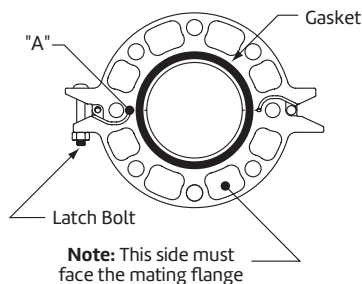

Fig. 7012 Gruvlok® Flange (2"-12")



Read and understand all instructions before use.

WARNING

Ensure system is drained and depressurized before installation or service.

Use appropriate personal protective equipment.



Failure to follow these instructions could result in serious personal injury and/or property damage.

4 Install Gasket

Stretch the Gruvlok gasket around the pipe end and then press the gasket into the cavity between the pipe O.D. and the flange. The gasket must be properly positioned as shown in the figure below.

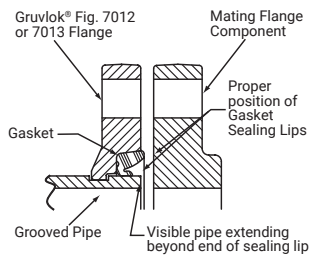

5 Lubricate Gasket Lip

With the gasket in place apply lubricant to the exposed gasket tip, which will seal on the mating flange. **Tighten the nuts on the latch bolts alternately to the specified latch bolt torque. The flange housings must be in for metal-to-metal contact.**

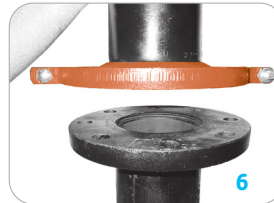

6 Inspect Mating Flange

Verify that the mating flange face is hard, flat and smooth, free of indentations, which would prevent proper sealing of the Gruvlok Flange gasket. Assure the gasket is still in the proper position and align Gruvlok Flange bolt holes with the mating flange, pump, tank, etc., bolt holes.



7 Install Bolting

Insert a flange bolt or stud with material properties of SAE J429 Grade 5 or higher through the bolt holes and thread a nut on hand tight. Continue this procedure until all bolt holes have been fitted. Tighten the nuts alternately and evenly so the flange faces remain parallel. All the bolts or studs must be torqued to the mating flange bolts specified torque. The flange faces should have metal-to-metal contact.

WARNING: It is important to line up the bolt holes before bringing the two flanges together. Sliding the flanges into place will dislodge the gasket and cause leakage to occur. When using a flange insert, it is important that the insert is properly aligned with the gasket prior to tightening the bolts.

Fig. C1 & C2

Note: The Gruvlok Fig. 7012 Flange requires the use of a Flange Adapter Insert when used against rubber surfaces (Figure C1), serrated flange surfaces or mating flanges with inserts (Figure C2). The Flange Adapter Insert will be exposed to the fluids in the system. Ensure that the Insert is compatible with the fluids in the systems and with adjacent piping components.

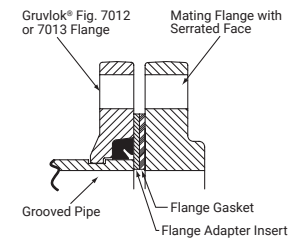

Fig. C1

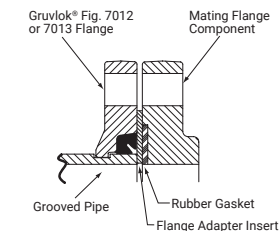

Fig. C2

WARNING: Do not use a steel Flange Adapter Insert in copper systems or in systems where galvanic corrosion is possible.

CAUTION: Proper torquing of flange bolts is required to obtain specified performance. Over torquing the bolts may result in damage to the bolt and/or casting which could result in pipe joint separation. Under torquing the bolts may result in lower pressure retention capabilities, lower bend load capabilities, joint leakage and pipe joint separation. Pipe joint separation may result in significant property damage and serious injury.

Fig. 7012 Gruvlok® Flange (14"-24")



Read and understand all instructions before use.

WARNING

Ensure system is drained and depressurized before installation or service.

Use appropriate personal protective equipment.



Failure to follow these instructions could result in serious personal injury and/or property damage.

Gruvlok Flanges of 14" size and larger are cast in four segments to ease handling during assembly. Figure 7012 Gruvlok Flanges should not be used with tie rods in a configuration with a wafer valve between two 7012 flanges.

1 Install Housing

Place each Gruvlok Flange segment around the grooved pipe with the key section fitting into the groove and the flange gasket cavity facing the pipe end. Loosely assemble the segments using the four segment-bolts-and nuts. Alternately and equally tighten the latch bolts and nuts to the specified latch bolt torque. Bring the four flange segments into full, firm metal to-metal contact.

Note: An alternative method of assembly is to loosely preassemble two segments into two equal halves of the flange leaving a small gap (approximately 1/8") between the two segments of each flange-half. Place the flange halves around the pipe and complete the assembly as described in Step 1, above.

2 Install Gasket

Check the gasket grade to verify that it is properly suited for the intended service. Lubricate the entire surface of the gasket and the flange cavity using the appropriate Gruvlok Lubricant. Place the Gruvlok Flange Gasket around the pipe end by pressing the gasket into the cavity between the pipe O.D. and flange recess. Move around the gasket in both directions until the gasket is fully seated in the flange gasket cavity.

3 Gasket Position

The correct position and relationship of the components of the Gruvlok Flange assembly is shown in the Figure above. The wide gasket lip must seal on the pipe surface diameter and the narrow gasket lip must face the mating flange. Be careful that foreign particles do not adhere to lubricated surfaces.

Note: Design of the Gruvlok Flange provides sealing only with the special Gruvlok Flange gasket. Only Gruvlok Flange gaskets may be used with Fig. 7012 flanges.

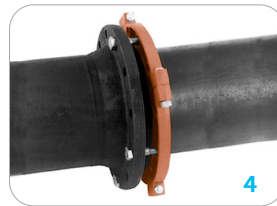
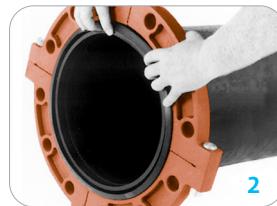
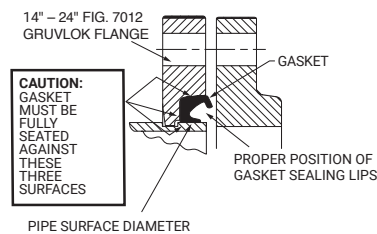

4 Inspect & Mate Flange

Align the Gruvlok Flange bolt holes with mating flange bolt holes. Insert a flange bolt or stud with material properties of SAE J429 Grade 5 or higher through the bolt holes and thread a nut on hand tight. Insert the next bolt or stud opposite the first and again thread the nut on hand tight. Continue this procedure until all bolt holes have been fitted. Insertion of the flange bolts prior to contact of the flanges will help in the alignment of the flanges. Pull the two flanges into contact using care to assure that the gasket remains fully seated within the gasket cavity during assembly.

Note: Take care to assure that the gasket lip is not bent backwards and pinched between the two flanges.

5 Install Bolting

Tighten the nuts evenly to the specified mating face bolt torque so that the flange faces remain parallel and make firm even contact around the entire flange.



CAUTION: Proper torquing of flange bolts is required to obtain specified performance. Over torquing the bolts may result in damage to the bolt and/or casting which could result in pipe joint separation. Under torquing the bolts may result in lower pressure retention capabilities, lower bend load capabilities, joint leakage and pipe joint separation. Pipe joint separation may result in significant property damage and serious injury.

Fig. 7042 Outlet Coupling

These instructions are based on pipe grooved in accordance with Grivlok® grooving specifications. Check pipe ends for proper groove dimensions and to assure that the pipe ends are free of indentations and projections which would prevent proper sealing. Fig. 7042 Outlet Coupling is recommended for use on straight runs of pipe, not recommended for use with Grivlok End Cap or Grivlok Cast Fittings.

1 Check & Lubricate Gasket

Check gasket to be sure it is compatible for the intended service. Apply a thin coating of Grivlok lubricant to the exterior surface and sealing lips of the gasket. Be careful that foreign particles do not adhere to lubricated surfaces.

2 Gasket Installation

Slip the gasket over one pipe end making sure the pipe abuts the gasket's center ribs.

3 Alignment

Align the pipe ends and pull the pipe into the gasket until the center ribs are in contact with the pipe ends. The gasket should not extend into the groove on either pipe. Rotate the gasket to align the outlet of the gasket to the same direction as the branch outlet.

4 Housing Assembly

With one nut and bolt removed and the other loosened, place one side of the housing over the gasket. Make sure the ribs on the outside of the gasket align with the recesses in the housing and the keys in the housing are in the grooves on both pipes. Swing the other housing over the gasket and into the grooves on both sides of the pipe. Make sure the recess in the outlet of the housing is properly aligned with gasket outlet.

5 Tighten Nuts

Re-insert the bolt and run-up both nuts finger tight. Securely tighten the nuts alternately and equally until they are completely tightened and there is no gap between the bolt pads. Continue tightening the nuts alternately and equally until the specified bolt torque is reached.

CAUTION: Make sure the ribs on the exterior of the gasket are enclosed in the housing recesses.

6 Assembly is Complete

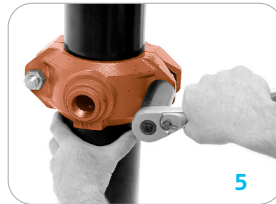

Fig. 7042 – Specified Bolt Torque

Specified bolt torque is for the oval neck track bolts used on Grivlok couplings and flanges. The nuts must be tightened alternately and evenly until fully tightened.

CAUTION: Use of an impact wrench is not recommended because the torque output can vary significantly due to many variables including air pressure supply, battery strength and operational variations.

CAUTION: Proper torquing of coupling bolts is required to obtain specified performance. Over torquing the bolts may result in damage to the bolt and/or casting which could result in pipe joint separation. Under torquing the bolts may result in lower pressure retention capabilities, lower bend load capabilities, joint leakage and pipe joint separation. Pipe joint separation may result in insignificant property damage and serious injury.

ANSI Specified Bolt Torque

Coupling Size	Bolt Size	Wrench Size	Specified Bolt Torque*
In.	In.	In.	Ft.-Lbs
1½	¾ x 2½	11/16	30-45
2	¾ x 2½	11/16	30-45
2½	½ x 2¾	7/8	80-100
3	½ x 3	7/8	80-100
4	5/8 x 3½	1 1/16	100-130
6	5/8 x 3½	1 1/16	100-130

* Non-lubricated bolt torques.

Fig. 7045 & Fig. 7046 Clamp-T Branch Outlets

ALWAYS USE A GRUVLOK LUBRICANT FOR PROPER COUPLING ASSEMBLY

Thorough lubrication of the gasket is essential to assist the gasket into the proper sealing position.

1 Pipe Preparation

Cut the appropriate size hole in the pipe and remove any burrs. Be sure to remove any debris from inside the pipe. Clean the gasket sealing surface within $\frac{5}{8}$ " of the hole and visually inspect the sealing surface for defects that may prevent proper sealing of the gasket.

Branch Size	Hole Saw Size
In.	In./(+ $\frac{1}{8}$, -0)
$\frac{1}{2}$, $\frac{3}{4}$, 1	1 $\frac{1}{2}$
1 $\frac{1}{4}$, 1 $\frac{1}{2}$	2
2	2 $\frac{1}{2}$
2 $\frac{1}{2}$	2 $\frac{3}{4}$
3	3 $\frac{1}{2}$
4	4 $\frac{1}{2}$

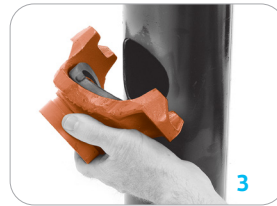

Figs. 7045 & 7046 Specified Bolt Torque

Specified bolt torque is for the oval neck track bolts and U-bolts used on the Guvlok Clamp-T's. The nuts must be tightened alternately and evenly until fully tightened. **CAUTION:** Use of an impact wrench is not recommended because the torque output can vary significantly due to many variables including air pressure, battery strength and operational variations.

CAUTION: Proper torquing of the bolts or U-bolts is required to obtain the specified performance. Over torquing the bolts or U-bolts may result in damage to the bolt, U-bolt and/or casting which could result in lower pressure retention capabilities, lower bend load capabilities, pipe joint leakage and pipe joint separation.

ANSI Specified Bolt Torque

Bolt Size	Wrench Size	Specified Bolt Torque*
In.	In.	Ft.-Lbs
U-Bolt	$\frac{7}{8}$	30-40
$\frac{1}{2}$	$\frac{7}{8}$	60-80
$\frac{5}{8}$	1 $\frac{1}{16}$	100-130
$\frac{3}{4}$	1 $\frac{1}{4}$	130-180

* Non-lubricated bolt torques

2 Check & Lubricate Gasket

Check the gasket to be sure it is compatible for the intended service. Apply a thin layer of Guvlok® lubricant to the back surface of the gasket. Be careful that foreign particles do not adhere to the lubricated surfaces. Insert the gasket back into the outlet housing making sure the tabs in the gasket line up with the tab recesses in the housing.

3 Gasket Installation

Lubricate the exposed surface of the gasket. Align the outlet housing over the pipe hole making sure that the locating collar is in the pipe hole.

4 Alignment

Align the strap around the pipe, insert the bolts and tighten the nuts finger tight. Some sizes use a U-bolt design.

5 Tighten Nuts

Alternately and evenly tighten the nuts to the specified bolt torque.

6 Assembly Complete

Fig. 7043 Branch Outlet

1 Pipe Preparation & Gasket Lubrication

Cut a $\frac{13}{16}$ " hole in the pipe and remove any burrs. Be sure to remove the slug from inside the pipe. Clean the gasket sealing surface within $\frac{1}{8}$ " of the hole and visually inspect the sealing surface for defects that may prevent proper sealing of the gasket. Remove the gasket from the housing and apply a thin layer of Gruvlok® lubricant to the back surface of the gasket. Be careful that foreign particles do not adhere to the lubricated surfaces. Insert the gasket back into the outlet housing making sure the tabs in the gasket line up with the tab recesses in the housing.



2 Gasket Installation

Lubricate the exposed surface of the gasket with Gruvlok lubricant.



3 Alignment

Align the outlet housing over the pipe hole making sure that the locating collar is in the pipe hole.

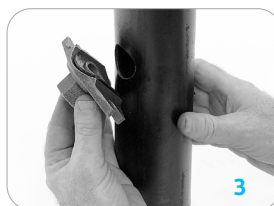

4 Housing Assembly

Attach the U-bolt from the other side and fasten the nuts finger tight.



5 Tighten Nuts

Making sure the fitting is properly located over the pipe hole, tighten the nuts alternately and evenly to the specified torque of 27 to 33 Lbs.-Ft. (37 to 45 N-m).



ALWAYS USE A GRUVLOK LUBRICANT FOR PROPER BRANCH OUTLET ASSEMBLY

Thorough lubrication of the gasket is essential to assist the gasket into the proper sealing position.

6 Assembly is Complete

Visually inspect the assembly, the gasket will extrude out from under the housing.

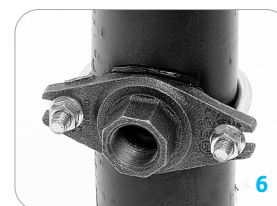

Specified Bolt Torque

The nuts must be tightened alternately and evenly until fully tightened.

CAUTION: Use of an impact wrench is not recommended because the torque output can vary significantly due to many variables including air pressure, battery strength and operational variations.

CAUTION: Proper torquing of the U-bolts is required to obtain the specified performance. Over-torquing the U-bolts may result in damage to the U-bolt and/or casting which could result in lower pressure retention capabilities, lower bend load capabilities, pipe joint leakage and pipe joint separation. Pipe joint separation may result in significant property damage and serious injury.

- Introduction
- Couplings
- Outlets
- Fittings
- Valves & Accessories
- High Pressure
- CTS Copper System
- DI-Electric Nipples
- Plan-End Fittings
- HDPE Couplings
- Socket-Fittings
- Stainless Steel Method
- Roll Croovers
- Installation & Assembly
- Special Coatings
- Design Services
- Technical Data
- Master Format 3 Part Specs.
- Pictorial Index

Fig. 7005 Roughneck® Coupling



Read and understand all instructions before use.

WARNING

Ensure system is drained and depressurized before installation or service.

Use appropriate personal protective equipment.



Failure to follow these instructions could result in serious personal injury and/or property damage.

1 Pipe Preparation

Make certain the pipe ends are free of indentations, projections, weld splatter, or other imperfections which could prevent proper sealing of the gasket.

2 Pipe Marking

Mark each pipe at a distance from the pipe end according to the pipe run size. See Image 1 and the chart.

3 Check & Lubricate Gasket

Check the gasket color code to verify that the gasket grade is properly suited for the intended service. Apply a thin coating of Gruvlok Lubricant to the gasket lips and the exterior surface of the gasket and slip the gasket over one pipe. See Image 2. Make sure the gasket does not overhang the pipe end.

Pipe Run Size

Pipe Size	Distance from Pipe End Mark	Bolt Torque	
		Min.	Max.
In./DN(mm)	In./mm	Ft.-Lbs./N-m	Ft.-Lbs./N-m
2-2½ 50-65	1 25.4	150 203	190 257
3-4 80-100	1 25.4	200 271	250 339
5-8 125-200	1¼ 31.8	250 339	300 406
10 250	1¾ 44.5	500 678	600 814
12 300	1¾ 44.5	550 746	700 949
14-16 350-400	1¾ 44.5	550 746	700 949

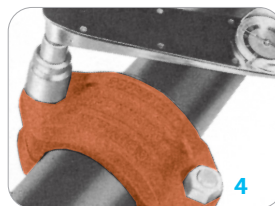
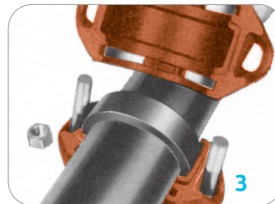

4 Pipe Alignment

Align the second pipe and while holding the pipe in the butted position slide the gasket back over the second pipe end. The gasket should be equally spaced between the lines scribed on each pipe.

5 Housing

Place each half of the Roughneck coupling over the gasket, making sure that the tongue on one housing half is aligned with the recess on the other housing half. See Image 3.

6 Tighten Nuts

Tighten the nuts alternately and uniformly until the required bolt torque is reached. See Image 4 and chart for bolt torque.

7 Reinstallation

Reinstallation after a disassembly will require that the threads on the bolt and in the nut are clean and lubricated with a light oil.

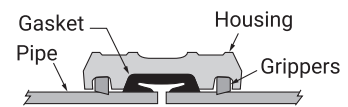

Note: Torque requirements must be met and housing halves must be assembled with equal gaps between bolt pads.

Working pressure and end load are based on a properly assembled Roughneck coupling with bolts fully torqued to the above specifications, on plain-end or beveled standard wall steel pipe and Gruvlok Plain-End Fittings.

Roughneck Couplings are designed to be used on plain-end pipe and Gruvlok Plain-End Fittings only. For externally coated pipe applications, contact an Anvil International Representative.

Not recommended for use on steel pipe with a hardness greater than 150 Brinell, plastic, HDPE, cast iron or other brittle pipe.

Re-Installation: The 7005 roughneck coupling may be re-installed following a quick visual inspection of the gripper and pipe ends. Any damage on the gripper and or pipe ends may compromise the integrity of the joint and it is advised that the coupling and or individual gripper be replaced and the pipe end cut back to where they are free from damage.

*Bolt torque ratings shown must be applied at installation.

Fig. 7004 Coupling



Read and understand all instructions before use.

WARNING

Ensure system is drained and depressurized before installation or service.

Use appropriate personal protective equipment.



Failure to follow these instructions could result in serious personal injury and/or property damage.

1 Check & Lubricate Gasket

Check gasket to be sure it is compatible for the intended service. Apply a thin coat of Gruvlok Lubricant to the exterior surface and sealing lips of the gasket. Be careful that foreign particles do not adhere to lubricated surfaces.



2 Gasket Installation

Slip the gasket over the pipe end, making sure the gasket lip does not overhang the pipe end.



3 Alignment

After aligning the two pipe ends together, pull the gasket into position, centering it between the grooves on each pipe. Gasket should not extend into the groove on either pipe.



4 Housings

Place each housing halves on the pipe making sure the housing key fits into the groove. Be sure that the tongue and recess portions of the housing mate properly. Insert the bolts and run up the nuts finger tight.



5 Tighten Nuts

Securely tighten nuts alternately and equally to the required indicator. For 2" - 4" 7004 couplings, please use the table below for required torque values. For 7004 5" and larger, tighten nuts till housings are in metal-to-metal contact.



6 Assembly is Complete

Visually inspect the pipe joint to assure the coupling keys are fully engaged in the pipe grooves. For 2" - 4", ensure the gaps on each side are evenly spaced, and for 5" and larger couplings ensure the housings are in firm even metal-to-metal contact on both sides.

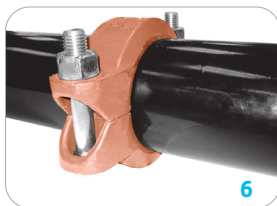

Specified Bolt Torque

Size	Bolt Size	Torque
In.	In.	Ft.-Lbs
2	5/8	100-130
2½	5/8	100-130
3	5/8	100-130
4	¾	100-130
5	7/8	*
6	7/8	*
8	1	*
10	1	*
12	1	*

* Torque required to bring housing metal-to-metal contact.

CAUTION: When using an impact wrench, verify that the output of the impact wrench is within the required torque range. It is recommended that a torque wrench be used for accurate assembly in order to obtain specified performance.

Fig. 7004EG High Pressure Coupling with End Guard Gasket



Read and understand all instructions before use.

WARNING

Ensure system is drained and depressurized before installation or service.

Use appropriate personal protective equipment.



Failure to follow these instructions could result in serious personal injury and/or property damage.

CAUTION

Not using the correct groove dimensions may result in pipe joint separation. Pipe joint separation may result in significant property damage and serious injury.

1 Check & Lubricate Gasket

Check gasket to be sure it is compatible for the intended service. Apply a thin coat of Gruvlok Lubricant to the exterior surface and sealing lips of the gasket. Be careful that foreign particles do not adhere to lubricated surfaces.



2 Gasket & Pipe Installation

Slip the gasket half way on to the pipe end, stop when the center gasket leg comes in contact with the pipe end. Slide the second pipe end half way into the gasket, stopping then the pipe end comes in contact with the center gasket leg. Ensure pipes are aligned properly.



3 Housings

Place each housing halves on the pipe making sure the housing key fits into the groove. Be sure that the tongue and recess portions of the housing mate properly. Insert the bolts and run up the nuts, finger tight.



4 Tighten Nuts

Securely tighten nuts alternately and equally until the housings are in firm metal to-metal contact.



5 Assembly is Complete

Visually inspect the pipe joint to assure the coupling keys are fully engaged in the pipe grooves. Ensure the housings are in firm even metal-to-metal contact on both sides.



Specified Bolt Torque

Size	Bolt Size	Torque
In.	In.	Ft.-Lbs
2	5/8	100-130
2½	5/8	100-130
3	5/8	100-130
4	¾	130-180
5	7/8	180-220
6	7/8	180-220
8	1	200-250
10	1	200-250
12	1	200-250

CAUTION: When using an impact wrench, verify that the output of the impact wrench is within the required torque range. Tool output varies and may require trial runs with the use of a torque wrench for accurate assembly.

Fig. 7377 Double Groove Coupling

1 Check and Lubricate Gasket

Check gasket to be sure it is compatible for the intended service. Apply a thin coat of Gruvlok Lubricant to the exterior surface and sealing lips of the gasket. Ensure that foreign particles do not adhere to the lubricated surface



2 Gasket Installation

Slip the gasket over the pipe end, making sure the gasket lip does not overhang the pipe end.

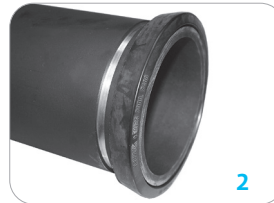

3 Alignment

After aligning the two pipe ends, pull the gasket into position, centering it between the grooves on each pipe. The gasket lip should not engage with either of the pipe grooves.

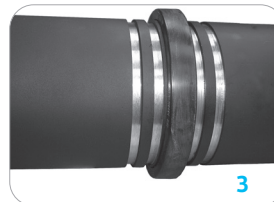

4 Housing

Place each half of the coupling housing over the gasket, making sure the housing keys engage the pipe grooves.

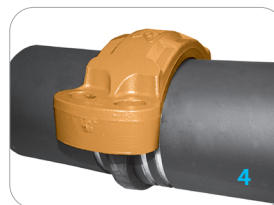

5 Bolts

Apply a thin coat of Xtreme Lube to the bolt threads. Tighten the nuts alternately and equally to the specified bolt torque.

CAUTION: Uneven tightening may result in the housings pinching the gasket and causing an improper seal.

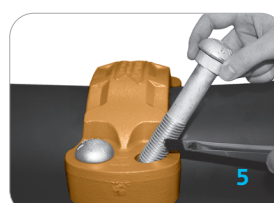

6 Final Assembly

Visually inspect the pipe joint to ensure the coupling keys are fully engaged in the pipe grooves, both bolt pads are a firm and even metal-to-metal contact, and the gasket is not visible.

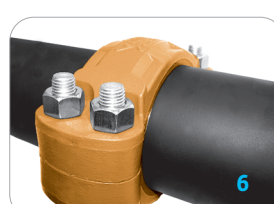

Ansi Specified Bolt Torque

Pipe Sizes	Bolt Size	Specified Bolt Torque	Lubrication
In.	In.	Ft.-Lbs	-
6	1	450 - 525	Gruvlok Xtreme™ Lubricant
8	1 1/8	500 - 600	
10	1 1/8	500 - 600	

CAUTION

When using an impact wrench, verify that the torque output on the impact wrench is within the required torque range. It is recommended that a torque wrench be used for accurate assembly in order to obtain specified performance.

Proper torquing of coupling bolts is required to obtain specified performance. Over torquing the bolts may result in damage to the bolt and/or casting which could result in pipe joint separation. Under torquing the bolts may result in lower pressure retention capabilities, lower bend load capabilities, joint leakage and pipe joint separation. Pipe joint separation may result in significant property damage and serious injury.

- Introduction
- Couplings
- Outlets
- Fittings
- Valves & Accessories
- High Pressure
- CTS Copper System
- DI-Electric Nipples
- Plan-End Fittings
- HDPE Couplings
- Sock-It® Fittings
- Stainless Steel Method
- Roll Groovers
- Installation & Assembly
- Special Coatings
- Design Services
- Technical Data
- Master Format 3 Part Specs.
- Pictorial Index

Fig. 7305 HDPE Coupling



Read and understand all instructions before use.

WARNING

Ensure system is drained and depressurized before installation or service.

Use appropriate personal protective equipment.



Failure to follow these instructions could result in serious personal injury and/or property damage.

1 Pipe Preparation

Ensure the HDPE pipe ends are square cut to $\frac{1}{8}$ " maximum for 2" to 4" sizes and $\frac{5}{32}$ " maximum for 6" sizes and larger. Ensure the gasket seating surface on each pipe end is clean and smooth for proper gasket sealing. Mark each pipe at a distance from the end as follows:

Size Inches	Distance to Mark
In./mm	In./mm
2-4 (51-102)	2 (25.4)
5-12 (127-305)	1½ (38.1)
14-18 (355-457)	1¾ (44.5)

CAUTION: For proper coupling performance, the gasket seating surface of each pipe end must be free of scratches, indentations, projections, or other imperfections that could prevent proper sealing of the gasket.

2 Check & Lubricate Gasket

Check to assure the gasket material is acceptable for the intended service. The Gasket color code is green for EPDM and orange for Nitrile (Buna-N).

CAUTION: Use only Gruvlok Xtreme™ Lubricant. Gruvlok Xtreme Lubricant contains silicone. If silicone is unacceptable for the application contact Gruvlok for the lubrication recommendation. Apply a thin coating of Gruvlok Xtreme Lubricant to the gasket lip and the exterior surface of the gasket.

3 Gasket Installation

Slip the gasket over one of the pipe ends. Make sure the gasket does not overhang the pipe end. Align the second pipe and while keeping the pipes in the butted position slide the gasket back over the second pipe end. The gasket must be positioned centrally between the lines on the pipe ends.

4 Housings

Place the Figure 7305 housing casting over the gasket, making sure the tongue on one casting is aligned with the recess of the other casting.

5 Tighten Nuts

Insert the bolts and secure the nuts alternately and uniformly until the bolt pads make contact. Torque all bolts to the required bolt torque levels shown in the Specified Bolt Torque Table. Alternate and even tightening of the bolts will significantly reduce the torque needed to close the coupling.

CAUTION: To ensure proper performance, the Figure 7305 HDPE coupling should always be installed with the bolt pads making metal to metal contact.

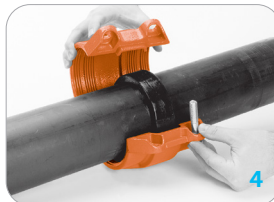
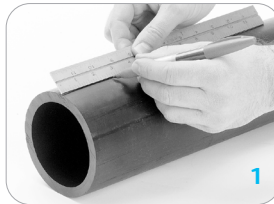

Specified Bolt Torque

Specified bolt torque is for the oval neck track bolts used on Gruvlok couplings. The nuts must be tightened alternately and evenly until fully tightened.

CAUTION: Use of an impact wrench is not recommended because the torque output can vary significantly due to many variables including air pressure supply, battery strength and operational variations.

CAUTION: Proper torquing of coupling bolts is required to obtain specified performance. Over torquing the bolts may result in damage to the bolt and/or casting which could result in pipe joint separation. Under torquing the bolts may result in lower pressure retention capabilities, lower bend load capabilities, joint leakage and pipe joint separation. Pipe joint separation may result in significant property damage and serious injury.

Specified Bolt Torque

Coupling Bolts	Minimum		Maximum	
	In./mm	Lbs./kg	In./mm	Lbs./kg
½ x 2¾	80	100	110	150
	80	100	110	150
½ x 3	100	130	135	175
	100	130	135	175
¾ x 4¾	130	180	175	245
	130	180	175	245
1 x 5½	200	250	270	340
	200	250	270	340

Fig. 7307 HDPE Transition Coupling



Read and understand all instructions before use.

WARNING

Ensure system is drained and depressurized before installation or service.

Use appropriate personal protective equipment.



Failure to follow these instructions could result in serious personal injury and/or property damage.

1 Pipe Preparation

Ensure the HDPE pipe ends are square cut to $\frac{1}{8}$ " maximum for 2" to 4" sizes and $\frac{3}{32}$ " maximum for 6" sizes and larger. The steel pipe must be grooved in accordance with Gruvlok Grooving Specification for Steel Pipe in the Technical Data Section. Ensure the gasket seating surface on each pipe end is clean and smooth for proper gasket sealing.

CAUTION: For proper coupling performance, the gasket seating surface of each pipe end must be free of scratches, indentations, projections, or other imperfections that could prevent proper sealing of the gasket.



2 Check & Lubricate Gasket

Check to assure the gasket material is acceptable for the intended service. The Gasket color code is green for EPDM and orange for Nitrile (Buna-N).

CAUTION: Use only Gruvlok Xtreme Lubricant. Gruvlok Xtreme Lubricant contains silicone. If silicone is unacceptable for the application contact Gruvlok for the lubrication recommendation. Apply a thin coating of Gruvlok Xtreme Lubricant to the gasket lip and the exterior surface of the gasket.



3 Gasket Installation

Slip the gasket over one of the pipe ends. Make sure the gasket does not overhang the pipe end. Align the second pipe and while holding it in the butted position, slide the gasket back over the second pipe end. The gasket must be positioned on the gasket seat surface of the grooved steel pipe. Make sure the gasket does not overhang into the pipe groove.



4 Housings

Place each half of the coupling housing over the gasket, making sure the housing grooved end is directed into the pipe groove.



5 Tighten Nuts

Insert the bolts and secure the nuts alternately and uniformly until the bolt pads make contact. Torque all bolts to the required bolt torque levels shown in the Specified Bolt Torque Table. Alternate and even tightening of the bolts will significantly reduce the torque needed to close the coupling.

CAUTION: To ensure proper performance, the Figure 7307 HDPE Transition Coupling should always be installed with the bolt pads making metal to metal contact.

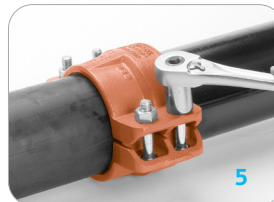

Specified Bolt Torque

Specified bolt torque is for the oval neck track bolts used on Gruvlok couplings. The nuts must be tightened alternately and evenly until fully tightened.

CAUTION: Use of an impact wrench is not recommended because the torque output can vary significantly due to many variables including air pressure supply, battery strength and operational variations.

CAUTION: Proper torquing of coupling bolts is required to obtain specified performance. Over torquing the bolts may result in damage to the bolt and/or casting which could result in pipe joint separation. Under torquing the bolts may result in lower pressure retention capabilities, lower bend load capabilities, joint leakage and pipe joint separation. Pipe joint separation may result in significant property damage and serious injury.

Specified Bolt Torque

Coupling Bolts	Minimum		Maximum	
	In./DN(mm)	In./mm	Lbs./kg	
$\frac{1}{2}$ x 2 $\frac{3}{8}$		80		100
		110		150
$\frac{1}{2}$ x 3		80		100
		110		150
$\frac{5}{8}$ x 3 $\frac{1}{2}$		100		130
		135		175
$\frac{5}{8}$ x 3 $\frac{3}{4}$		100		130
		135		175
$\frac{3}{4}$ x 4 $\frac{3}{4}$		130		180
		175		245
$\frac{7}{8}$ x 5 $\frac{1}{2}$		180		220
		245		300

Fig. 7312 HDPE Flange Adapter



Read and understand all instructions before use.

WARNING

Ensure system is drained and depressurized before installation or service.

Use appropriate personal protective equipment.



Failure to follow these instructions could result in serious personal injury and/or property damage.

1 Pipe Preparation

Ensure the HDPE pipe ends are square cut to $\frac{1}{8}$ " maximum for 2" to 4" sizes and $\frac{5}{32}$ " maximum for 6" sizes and larger. Inspect the surface of the mating flange to ensure the gasket seating surface is clean and smooth for proper gasket sealing.

CAUTION: For proper coupling performance, the gasket seating surface of each pipe end must be free of scratches, indentations, projections, or other imperfections that could prevent proper sealing of the gasket.

2 Check & Lubricate Gasket

Check to assure the gasket material is acceptable for the intended service. The Gasket color code is green for EPDM and orange for Nitrile (Buna-N).

CAUTION: Use only Gruvlok Xtreme Lubricant. Gruvlok Xtreme Lubricant contains silicone. If silicone is unacceptable for the application contact Gruvlok for the lubrication recommendation. Apply a thin coating of Gruvlok Xtreme Lubricant to the gasket lip and the exterior surface of the gasket.

3 Housing

Place the housing over the end of the pipe and using a straight edge, align the face and the flange face with the end of the pipe. Do not let the pipe extend beyond the flange face.

4 Latch Housing

Tighten the housing nut until the housing bolt pads make firm metal to metal contact. Torque all bolts to the required latch bolt torque levels. Refer to the Specified Latch Bolt Torque Table.

CAUTION: For proper performance, the Figure 7312 HDPE Flange adapter should always be installed with the housing bolt pads making metal to metal contact.

5 Install Gasket

Position the Gruvlok Flange gasket around the pipe end and press the gasket into the flange gasket pocket. Be sure the flange sealing lips are facing out.

6 Align Pipe

Align the Gruvlok Flange bolt holes with the mating flange bolt holes. Insert a standard bolt or stud through one bolt hole and thread the nut on hand tight. Insert the next bolt or stud opposite the first and thread the nut on hand tight. Continue this procedure until all holes have been fit ed.

CAUTION: Take care to assure the gasket lip is not bent backwards and pinched between the two flanges.

7 Tighten Bolts

Tighten the flange face nuts alternately and evenly so that the flange faces remain parallel and make firm contact around the entire flange. Torque all bolts to the required mating flange joint torque levels. Refer to the Specified Mating Flange Bolt Torque Table.

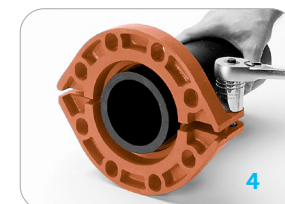
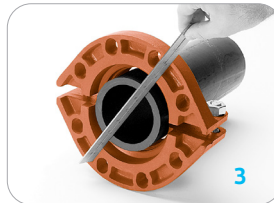

Specified Bolt Torque for Latch & Mating Flange Bolts

Specified bolt torque is for the latch and mating flange bolts used on Gruvlok flanges. The nuts must be tightened alternately and evenly until fully tightened.

CAUTION: Use of an impact wrench is not recommended because the torque output can vary significantly due to many variables including air pressure supply, battery strength and operational variations.

CAUTION: Proper torquing of latch and mating flange bolts is required to obtain specified performance. Over torquing the bolts may result in damage to the bolt and/or casting which could result in pipe joint separation. Under torquing the bolts may result in lower pressure retention capabilities, lower bend load capabilities, joint leakage and pipe joint separation. Pipe joint separation may result in significant property damage and serious injury.

Latch Bolt Torque

Coupling Bolts	Minimum	Maximum
In./DN(mm)	Ft.-Lbs/N-m	Ft.-Lbs/N-m
$\frac{5}{8}$ x 2	100	130
	135	175
$\frac{3}{4}$ x 3 $\frac{1}{2}$	130	180
	175	245

Mating Flange Bolt Torque

Coupling Bolts	Minimum	Maximum
In.	Ft.-Lbs/N-m	Ft.-Lbs/N-m
$\frac{5}{8}$ x 3	110	140
	149	190
$\frac{3}{4}$ x 3 $\frac{1}{2}$	220	250
	298	339

Gruvlok Sock-It® Fittings

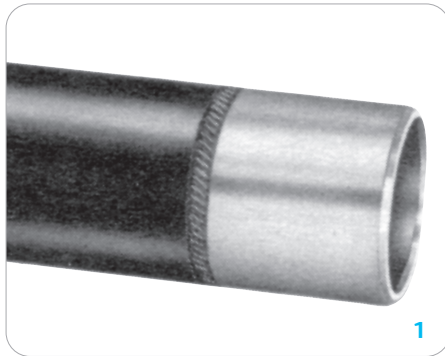

1 Pipe Preparation —

Pipe surface shall be cleaned at least 1" from the end of the pipe to remove any coating, indentations, projections, and sharp edges which could affect proper gasket sealing. As a guide for installation, mark the pipe at a distance of 1½" from the end for 1", 1¼", and 1½" size fittings and 1¾" for the 2" & 2½" size fittings

NOTE: When Allied XL pipe is used it is necessary only to remove sharp edges and burrs at the end of the pipe. No additional cleaning is required.

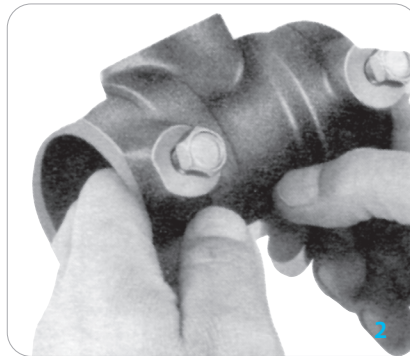

2 Check Bolts —

Check all lock bolts to be sure they do not extend into the I.D. of the Sock-It Fittings as this would prevent proper insertion of the pipe.

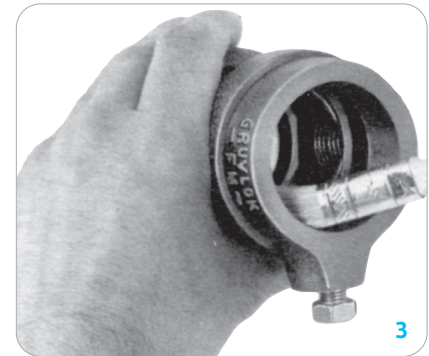

3 Lubricate Gaskets —

Apply a light coating of Gruvlok Lubricant to the gaskets located in each end of the Sock-It Fitting. Also apply a light coating of lubricant to the pipe ends to further ease insertion of the pipe into the Sock-It Fitting.

NOTE: Use only Gruvlok Lubricants. Other lubricants may affect gasket performance.

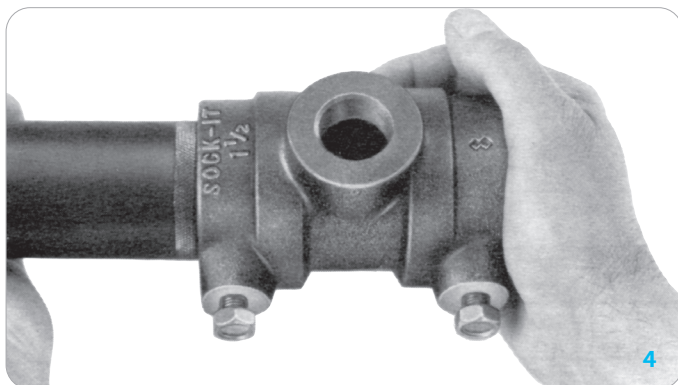

4 Insert Pipe & Tighten Bolts —

Insert the prepped and lubricated pipe end into the Sock-It Fitting until the pipe end makes contact with the internal pipe stop. A slight twist while pushing fitting and pipe together will ease the required insertion force. The end of the Sock-It Fitting should be within ¼" from the edge of the marking on the pipe. (See Step 1). Rotate the fitting until the desired position is obtained. Tighten the lock bolt until the bolt head bottoms against the threaded boss.

(NOTE: The 2½" Sock-It fitting has 2 locking bolts for each pipe end.)

Install the other prepped and lubricated pipe end into the Sock-It fitting in the same manner.

CAUTION: Do NOT hammer fitting on

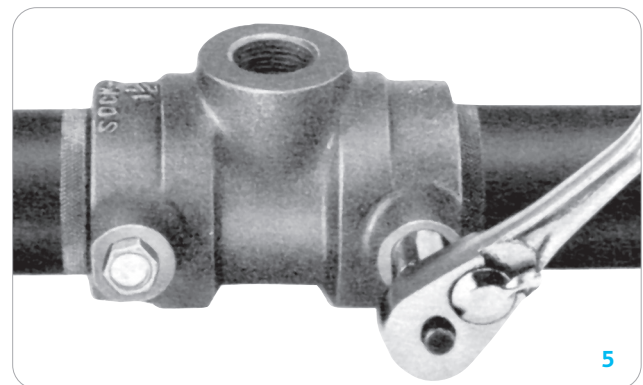

5 Assembly Is Complete —

Lock-It Fittings may be removed by loosening the lock bolts. Reinstallation may be accomplished as described in Steps 1-4.

WARNING: System pressure must be relieved and vented, and the system drained of fluid prior to loosening the lock bolts to remove or reposition the Sock-It Fitting.

Bolt end must be inspected to assure bolts ability to cut into pipe. Replace bolts in cases where bolt end sharpness has been comprised.

FTV-S (Straight) & FTV-A (Angle Body) Tri-Service Valve

Installation:

- Step 1** The valve should be mounted to a spool piece on the discharge side of the pump. Spool piece required is based on a minimum recommended space of 12" for pump sizes 2" x 2" to 6" x 6" and 24" for pump sizes 8" x 8" to 12" x 12".
- Step 2** It is not recommended to mount a valve directly to the pump as this could cause undesirable noise in the system.
- Step 3** Sufficient clearance around the valve should be left for valve removal or repair.
- Step 4** Install valve in the direction of the flow arrows on the valve body.

- Step 5** The valve can be mounted to flanged equipment using Gruklok Flange Adapter or industry standard grooved coupling, suitable for system pressure and temperatures encountered.
- Step 6** The Gruklok Tri-Service valve bodies have anti-rotation lugs on the inlet and outlet. These lugs, combined with the Flange Adapters, provide a ridged rotation free installation.
- Step 7** The valve body has been designed to handle the weight of the pump on vertical in-line installations. The body is not designed to support the piping weight. It is recommended that the piping be supported by hangers. Pipe supports should be provided under the valve and strainer bodies.

Typical Installations

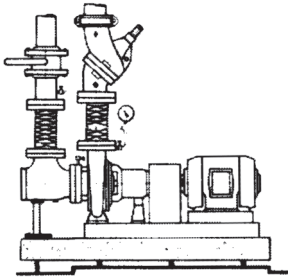

Base-Mounted Single Suction

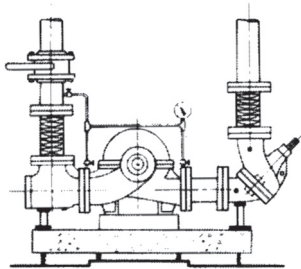

Base-Mounted Double Suction

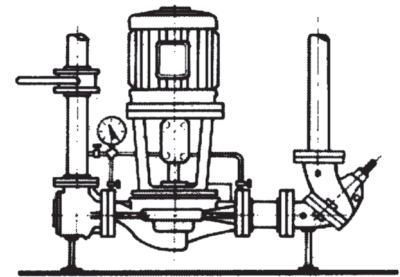

Vertical In-Line

Field Conversion

(Straight to Angle Pattern Valve)

- Step 1** Open valve at least one complete turn.
- Step 2** Remove the body bolts from valve body using Allen Key.
- Step 3** Rotate one half of the valve body 180° making sure the lower valve seat and "O" Ring stay in position. Inspect the "O" Ring for any cuts or nicks and replace if necessary.
- Step 4** Replace body bolts and torque evenly to 70 ft./lbs.

PRESSURE - TEMPERATURE LIMITS

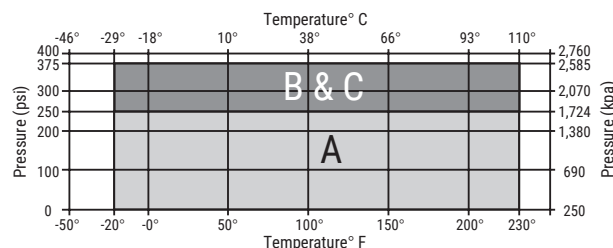

Note: for temperatures between 230°F and 300°F (110°C and 149°C) specify Viton Elastomers.

LEGEND	
A	Gruklok ductile iron flange adapters for ANSI 150# flanges
B	Gruklok ductile iron flange adapters for ANSI 300# flanges
C	Grooved end with 375 psi rated pipe coupling

Flow Measurement

Where approximate indication of flow is acceptable the Gruklok Tri-Service valve can be used.

Flow Measurement Valve in Wide Open Position

Measure and record the differential pressure across the valve using a Flow Meter with high pressure range transducer or pressure gauges with PMP adapters.

Refer to Tri-Service Performance Curves with valve in full open position (See Determining Flow Rate with Valve in Throttled Position Section on page 264). Locate Pressure Differential on left hand side of chart and extend line horizontally across to valve size being used. Drop line vertically down and read flow rate from bottom of chart.

CAUTION:

Safety glasses should be used and the probe should not be left inserted into fittings for prolonged periods of time (overnight, etc.), as leakage from the PMP may occur when probe is removed.

FTV-S (Straight) & FTV-A (Angle Body) Tri-Service Valve

Determining Flow Rate with Valve in Throttled Position:

Step 1 Record the size of valve and stem position using the Flow Indicator Scale (See Flow Indicator Section at bottom of page). Calculate percentage of valve opening referring to table below:

Valve Size	2 1/2"	3"	4"	5"	6"	8"	10"	12"
Number of Rings (valve full open)	5	5	6	9	10	12	18	28

Step 2 Measure and record the differential pressure across the valve in the throttled position.

Step 3 Locate percentage of valve opening on the bottom scale of Flow Characteristic Curve. Project line vertically up to intersect with the Valve Characteristic Curve and from this point project line horizontally across to the left of the chart and record the percentage of maximum flow rate.

Step 4 On the Tri-Service Performance Curve locate the differential pressure obtained in Step 2 and project line horizontally across to intercept with Valve Performance Curve. Drop a line vertically down to read the flow rate at the bottom of the chart.

Step 5 To calculate flow rate of valve in the throttled position, multiply the flow rate from Step 4 by the percentage flow rate from Step 2 divided by 100.

Example Valve size 4 in.
Differential Pressure in 5.4 ft. (1.65 m)
Number of rings open 3, (3 rings / 6 rings X 100) = 50% throttle

Solution From the Tri-Service Performance Curve (fig. 5), a 4 in. valve with 5.4 ft. pressure drop (1.65 m) represents a flow of 400 USgpm (25.2 L/s).

From Flow Characteristic Curve (fig. 6), a 4 in. valve, 50% open, represents 34% of maximum flow.

Approximate flow of a 4 in. valve, with a 5.4 ft. (1.65 m) pressure drop when 50% throttled is:
 $(400 \times 34) / 100 = 136$ USgpm
 $(25.2 \times 34) / 100 = 8.57$ L/sec.

Note: To prevent premature valve failure it is not recommended that the valve operate in the throttled position with more than 25 ft. pressure differential. Instead the pump impeller should be trimmed or valves located elsewhere in the system to partially throttle the flow.

Flow Indicator Lines

The valve stem with its grooved rings and positioning sleeve indicates the throttled position of the valve. The quarter turn graduations on the sleeve, with the scribed line on the stem, provide for approximate flow measurement.

Note:
The valve is shipped in the closed position.
The indicator on the plastic sleeve is aligned with the vertical scribed line on the stem.

Tri-Service Performance Curve with Valve in Full Open Position

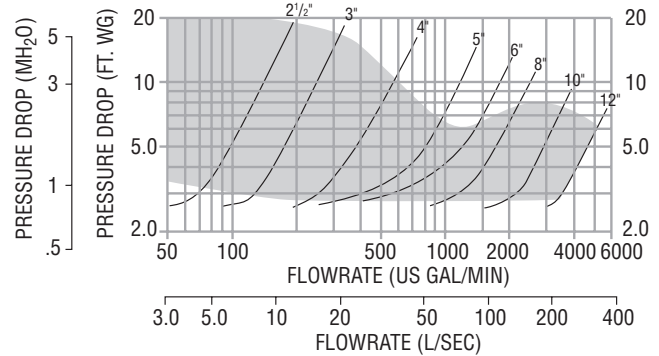

Inherent Flow Characteristic Curve with Valve in Throttled Position

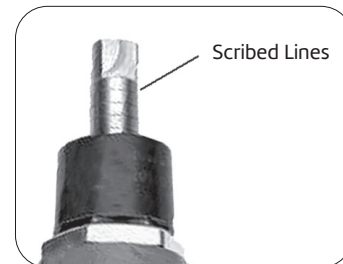
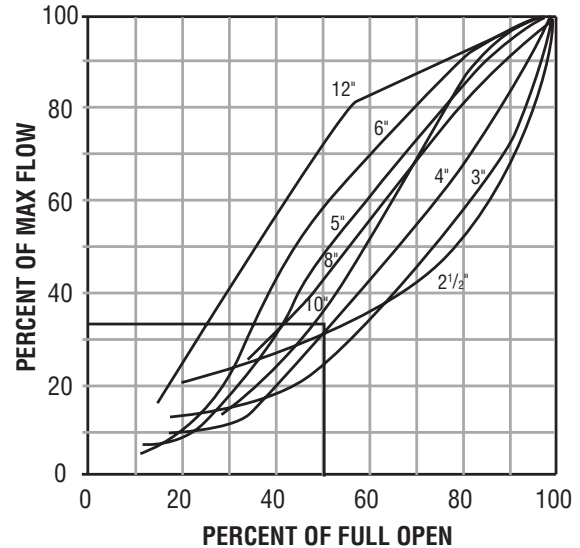

- Introduction
- Couplings
- Outlets
- Fittings
- Valves & Accessories
- High Pressure
- CTS Copper System
- DI-Electric Nipples
- Plan-End Fittings
- HDPE Couplings
- Socket-Fittings
- Stainless Steel Method
- Roll Groovers
- Installation & Assembly
- Special Coatings
- Design Services
- Technical Data
- Master Format 3 Part Specs.
- Pictorial Index

FTV-S (Straight) & FTV-A (Angle Body) Tri-Service Valve

Operation

To assure tight shut off the valve must be closed using a wrench with 25 to 30 ft./lbs of torque.

To assure trouble-free check valve operation and shut off operation, the valve should be periodically opened and closed to keep valve seat and valve disc guide stem free of build up of system contaminants.

Repacking of FTV Value Under Full System Pressure

Should it be necessary, stem "O" Ring can be changed under full system pressure.

CAUTION: Safety glasses should be worn.

- Step 1** Record the valve setting.
- Step 2** Turn the valve stem counterclockwise until the valve is fully open and will not turn any further. Torque to a maximum force of 45 ft./lbs. This will ensure good metal-to-metal contact and minimum leakage.
- Step 3** The valve bonnet may now be removed. There may be a slight leakage, as the metal-to-metal backseating does not provide a drip-tight seal.
- Step 4** Clean exposed portion of valve stem (Do not scratch).
- Step 5** Remove and replace the "O" Ring and gasket.
- Step 6** Install the valve bonnet.
- Step 7** Tightening valve bonnet is necessary to stop any leaks.
- Step 8** Open valve to balance set point as recorded in Step 1.

Maximum Number of Turns Full Open Valve

On valve sizes 2½" and 3", full open position of valve is 5 turns. However, valve will open to 5½ turns which is just back of seating of valve.

Seat Replacement

- Step 1** Drain system and remove valve from piping.
- Step 2** Remove the body bolts from the body using an Allen Key one full position.
- Step 3** Remove seat and "O" Ring. "O" Ring is not used on valves 8" and larger.
- Step 4** Clean exposed portion of valve stem (Do not scratch).
- Step 5** Remove and replace the "O" Ring and gasket.
- Step 6** Inspect and clean "O" Ring cavity and install new "O" Ring and seat. Valve disc stem also should be inspected and replaced if worn. Valve stem "O" Ring should be replaced at this time.

Model 4 Circuit Balancing Valves

Gruvlok CB800 Circuit Balancing Valves are designed for installation in hot water heating and chilled water air conditioning systems and serve to achieve a hydronic balance between the various circuits of the system.

These installation instructions are designed for the Grooved and Flanged type Circuit Balancing Valves.

General Instructions

Always read and understand the instructions. Never remove any piping component without verifying that the system is depressurized and drained.

It is the designer's responsibility to select products suitable for the intended service and to ensure that pressure ratings and performance data are not exceeded.

The valve may be installed in supply or return line. Install the valve with the flow in the same direction as the arrow cast in the body.

Valve must be installed with a minimum of 3D (3 x nominal pipe diameter) of straight pipe in the upstream side.

Valve may be installed in the vertical or horizontal position, with the hand-wheel up, down or on the side.

Pre-Setting

The required preset value can be obtained by referencing the flow chart for the appropriate size of valve. Following the steps below, adjust the basic and fine adjustment scale on the handwheel to match the selected presetting.

Step 1 The preset value of the valve is adjusted with the handwheel (Ref. Figure 1 or 2).

Step 2 Turn the handwheel so that the arrow on the sliding indicator matches the basic adjustment value. One complete turn of the handwheel adjusts the indicator one full position.

The fine setting is displayed in the scale under the handwheel and indicates $\frac{1}{10}$ th of a turn of the handwheel.

Step 3 With the valve open to the preset value, use a small screwdriver and gently pry the cover plug out of the hand-wheel. Using a 4 mm Allen key for the 2½ to 6 inch, or a 10 mm screwdriver for the 8 to 12 inch, insert the tool into the screw (Ref. Figure 1 or 2) and turn clockwise until tight. This will lock the hand-wheel so that the valve can not be opened beyond the preset value. The handwheel may still be turned to the closed position. Replace the cover plug.

Repositioning the Handwheel

Depending on the position of the valve in the system, it may be desirable to move the 2½ inch to 6 inch handwheel and adjustment scales to make it easier to read.

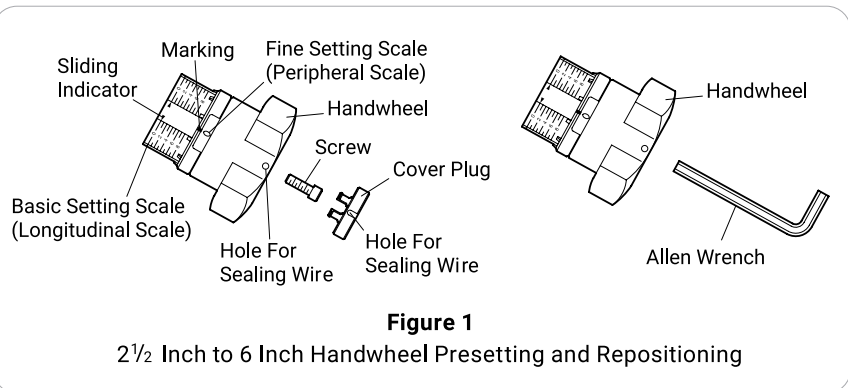

Step 1 Ensure the valve is closed and the adjustment scale is set at 0.

Step 2 Use a small screwdriver and gently pry the cover plug out of the hand-wheel.

Step 3 Use a 6mm Allen key for the 2½ inch to 6 inch handwheel to remove the Allen screw (Ref. Figure 1).

Step 4 Gently pull the handwheel up and remove it from the valve spindle.

Step 5 Reposition the handwheel so that the adjustment scale is visible and slide the handwheel down on the spindle.

Step 6 Replace the screw and tighten.

Step 7 Replace the cover plug.

Protecting the Setting

A sealing wire may be threaded through the hole in the handwheel (Ref. Figure 2 or 3) and the lead seal to be fixed to prevent tampering of the setting.

Locking the Handwheel

Locking 2½ Inch to 6 Inch Handwheel
The hand wheel can be locked in any position. Slide the enclosed clip into the cut-out in the hand wheel between the guides (Ref. Figure 3), making sure it locates into the sliding indicator. Attach the lead seal wire through the hole in the clip then through the hole in the side of the hand wheel. Ensure the sealing wire is fit ed tightly, then crimp the seal.

Locking 8 Inch to 14 Inch Handwheel
The handwheel can be locked in any position ($\frac{1}{10}$ th of a turn) by removing the existing cover plug and replacing it with a special one. The sealing wire is fit ed through the hole in the handwheel and a Lead Seal is fit ed (Ref. Figure 2).

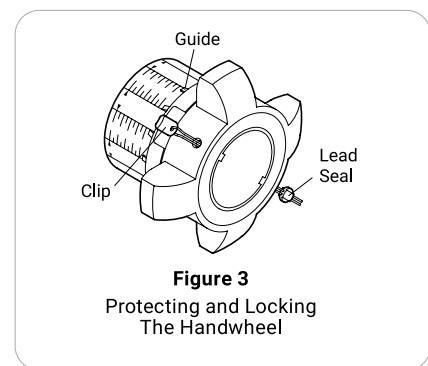
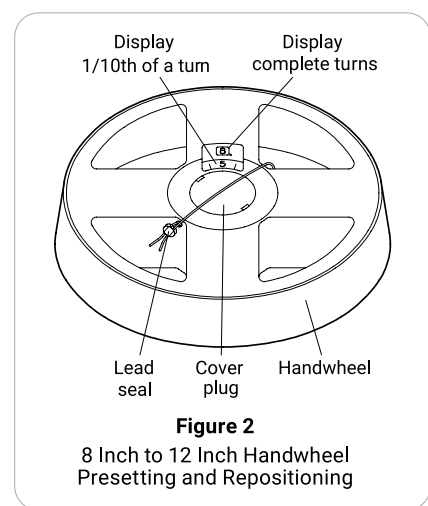

Notice: For presetting and fine adjustment of the flow volume, use the Gruvlok Model MC2 flow computing hand held Differential Measuring Computer.

AnvilFlex® Fig. AF-21-GG, -GF & -FF Flex Connectors

Installation

- 1 Avoid torque. Do not twist the hose assembly during installation when aligning the bolt holes in a flange or in making up pipe threads. The utilization of lap joint flanges or pipe unions will minimize this condition.
- 2 To install a thread end braided metal hose assembly unions must be used. Do not place wrenches on the braided portion or the collar of the braided metal hose assembly. Use care not to torque the braided metal hose assembly while tightening the union. It is recommended that two wrenches be used in making the union connection; one to prevent the hose from twisting and the other to tighten the coupling.
- 3 Install the braided metal hose assembly with neutral face-to-face dimension as shown on the submittal drawing. Do not install a braided metal hose assembly compressed (bagged braid). The corrugated inner hose contains the fluid, the braid is designed to take the stress of system pressurization and contain the core.
- 4 If the braided metal hose assembly must be installed with an initial offset then the maximum allowable movement is reduced by the amount of the initial deflection
- 5 Avoid over bending. The repetitive bending of a hose assembly to a radius smaller than the radius specified will result in early hose failure. Always provide sufficient length to prevent over bending and to eliminate strain on the hose assembly. Utilize sound geometric configurations that avoid sharp bends, especially near the end fittings of the assembly.
- 6 Verify that the movements of the system are within the design parameters of the braided metal hose assembly being installed.
- 7 Prevent out-of-plane flexing in an installation. Always install the hose assembly so that the flexing takes place in only one plane—this being the plane in which the bending occurs.
- 8 The maximum system test pressure must not exceed 150% of the maximum rated working pressure as shown.
- 9 Check system pressure and temperature and do not exceed recommended performance limits. Operation beyond design limits will result in premature failure.
- 10 The corrugated metal hose alloy must be chemically compatible with the media in the piping system. If in doubt as to suitability, refer to a Chemical Resistance Data table or contact your Anvil rep. for guidance.
- 11 The flanges on a concentric increasing braided metal hose assembly have the bolt holes straddling the hose centerline. The mating flanges should also straddle the centerline to avoid torque on the braided metal hose assembly.



- 12 When installing weld end, or sweat end, braided metal hose assemblies, or when welding in the area of a braided metal hose assembly, extreme care is necessary in ensure no weld spatter comes in contact with the braided hose sections.
- 13 A piping system, which utilizes braided metal hose to absorb movement, must be properly anchored and/or guided. Always support the piping to prevent excessive weight from compressing the hose and relaxing the braid tension.
- 14 Use care when handling the braided metal hose assembly during transportation, storage, and installation. The braided hose sections must not be allowed to bend, deflect, sag, or otherwise extend beyond their rated capabilities.
- 15 The shipping sticks, on flanged units, are to keep the braided metal hose assembly in its neutral end-to-end dimension during shipping and installation. After installation, the shipping sticks should be removed.

Maintenance

- 1 The braided metal hose assembly should be inspected during routine maintenance to ensure there are no signs of external damage. Inspect for frayed or broken braid wires. Also inspect to ensure there is no damage to the hose. In the event that such damage is found, the braided metal hose assembly should be replaced.
- 2 During system shutdown braided metal hose assembly should be examined to verify no thermal axial motion has occurred causing compression of the assembly.

Digital Design Solutions



Design Smarter. Build Better.

designsmarterbuildbetter.com

There's an essential goal we share with you: to engineer the best solution for your requirements.

Our tools, content and portals make it easier to access the information and expert support you need to get the job done, simply and quickly. We're constantly adding more content and enhancing our solutions to serve your design needs better and make your job easier.

For more information about our digital design solutions, visit designsmarterbuildbetter.com or contact your ASC Engineered Solutions sales representative.

Introduction

Couplings

Outlets

Fittings

Valves & Accessories

High Pressure

CTS Copper System

DJ-Electric Nipples

Plain-End Fittings

HDPE Couplings

Socket-It® Fittings

Stainless Steel Method

Roll Croovers

Installation & Assembly

Special Coatings

Design Services

Technical Data

Master Format 3 Part Specs.

Pictorial Index

ASC Tools Autodesk® Revit® Plug In

**Our free plug in allows you to easily load
ASC Engineered Solutions products into
a Revit design Project.**

- Design with smart pipe routing and fitting families in our catalog complete with all available sizes, assemblies, and downloads
- Adaptable, customizable, and always accurate
- Save labor and material costs
- Save time by automating and enhancing mechanical workflows
- Simplified tagging, scheduling, and spool sheet creation
- Produce a complete Bill of Materials

Download the plug in at
www.asc-es.com/asc-tools

BIM & CAD Content Library

Our complete BIM & CAD design file library is available for download at asc-es.com/bim-portal and it's always free.

We are constantly expanding our content, adding new product lines to the library each quarter and enabling our customers to digitally design using ASC products in their preferred BIM software program.

File formats available include:

- Revit® families
- 2D & 3D CAD file
- Fabrication content components (.ITM file)

Our BIM and CAD files contain complete, detailed product data that allows you to design with confidence and ease. They're customizable so they integrate into your designs seamlessly.

We are committed to providing digital design solutions that allow our customers to design smarter and build better.

Have a question about our digital design library? Contact our team at BIM@asc-es.com.

- Introduction
- Couplings
- Outlets
- Fittings
- Valves & Accessories
- High Pressure
- CTS Copper System
- D-I-Electric Nipples
- Plan-End Fittings
- HDPE Couplings
- Socket-It® Fittings
- Stainless Steel Method
- Roll Groovers
- Installation & Assembly
- Special Coatings
- Design Services**
- Technical Data
- Master Format 3 Part Specs.
- Pictorial Index

Virtual Design & Construction Technology Services

Our team of experienced digital design engineers can produce fabrication drawings of mechanical room piping 2 1/2" and larger such as chillers, heat exchangers, boilers and pumps from contractor-supplied flow diagrams, mechanical drawings and approved submittals and specifications.

A typical design review results in a 10 – 15% fitting count reduction. Additional savings can be generated by repositioning needed equipment for optimal design.

If you have further design needs, ASC offers Extended Design Services including fully dimensional fabrication drawings with a BOM by component, dimensional floor penetrations, commercial piping, and assistance with retrofit projects.

**Contact our team about
your design project needs
at VDC@asc-es.com.**

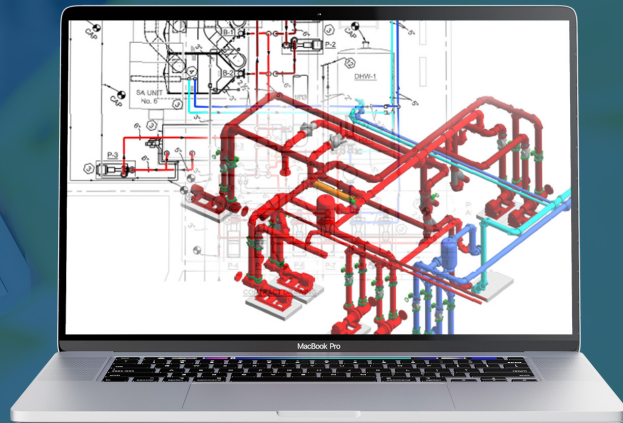

Technical Data Table of Contents

Gruvlok® Lubricants	387-388	Coupling Working Pressure Rating on CPVC Pipe	401
Specified Bolt Torque	389	Pipe Support	402-404
Design Factors	389	Coupling Flexibility	405-406
Gruvlok Flow Control Components	390	Drafting Symbols for Gruvlok® Piping Systems	407
Gruvlok Gasket-Styles	391	Pipe-Preparation	408-409
Gasket Grade Index	392	Roll Groove Specification	410
Gruvlok Gasket Recommendations	392-394	Cut Groove Specification	411
Movement-Applications	395-396	Cut Groove End Guard® Specification	412
Coupling Working Pressure Rating on Light Wall Roll Grooved Steel Pipe	397	Roll Groove End Guard® Specification	412
Coupling Working Pressure Rating on Roll Grooved ISO Steel Pipe	398	Double Cut Groove Specification	413
Coupling Working Pressure Rating on 304 & 316 Stainless Steel Roll Grooved Pipe	399	Gruvlok CTS Copper System Specification	414
Coupling Working Pressure Rating on Aluminum Pipe	400	CPVC Cut Groove Specification	415
		Master Format 3 Part Specifications	416

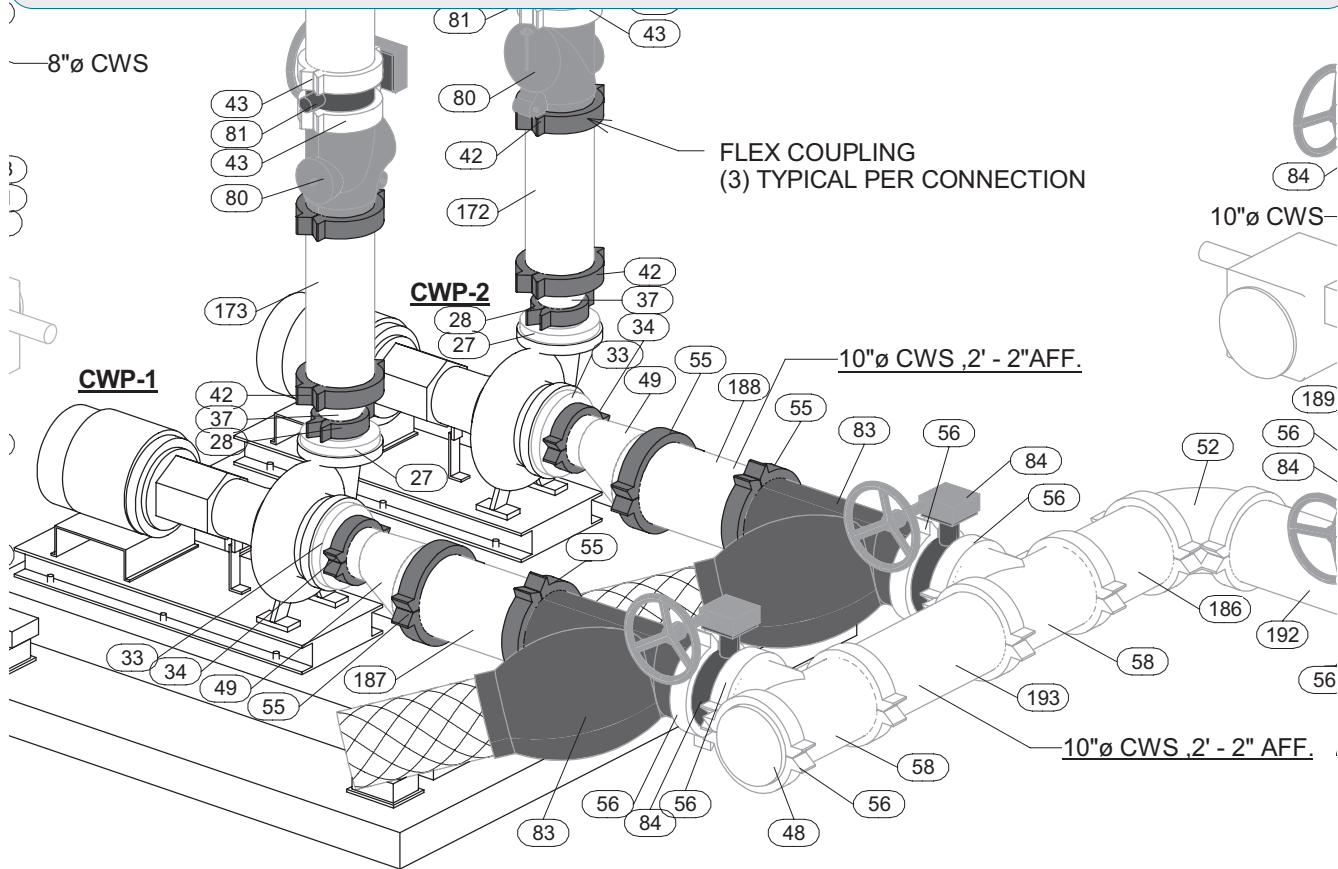

Gruvlok Xtreme Lubricant Gruvlok Quick Dry Lubricant Gruvlok Lubricant



Gruvlok Xtreme Lubricant

Gruvlok Quick Dry Lubricant

Gruvlok Lubricant



Gruvlok Xtreme Lubricant

Gruvlok Xtreme Lubricant has been developed for use with Gruvlok couplings in services where improved lubrication is beneficial. This lubricant has an operating temperature range from -65°F to 400°F (-53.8°C to 204°C), well exceeding the temperature range of Gruvlok gaskets. This lubricant is waterproof, thereby eliminating water wash-out and it will not dry out in the absence of water. There are five primary applications where the Xtreme Lubricant will provide increased benefits: low temperature applications below 32°F (0°C), high temperature applications above 150°F (65.6°C), applications where increased pipe joint flexibility is needed, lubrication of gaskets in copper systems, and for the lubrication of gaskets on HDPE couplings. Since it is formulated from a non-hydro carbon base, it can be used with EPDM, Nitrile and Fluoroelastomer gasket materials. **It is not to be used with Silicone gaskets.**

Material Specifications

- In low temperature applications the gasket will shrink, thereby lowering the sealing force on the gasket sealing lips. The temperature change will also force the gasket to slightly re-position itself. This will cause pipe end sealing surfaces, with small cuts or damage, to become more susceptible to leakage. Gruvlok Xtreme Lubricant will maintain its lubricating properties.

Material Specifications (Continued)

- At lower temperatures allowing a properly lubricated pipe end and gasket (assembly) to reposition itself during temperature cycles.
- For high temperature service and copper systems, it is required that the gasket be lubricated with a light thin coating on the inside of the gasket. Gruvlok Xtreme lubrication will maintain its lubricating properties at higher temperatures, allowing a properly lubricated pipe end and gasket assembly to re-position itself during temperature cycles. Lubrication of the pipe end and gasket will help the gasket to adjust into the proper sealing position during temperature cycles. The lubricant on the interior of the gasket will act to improve the chemical resistance of the gasket material by providing a thin lubricant barrier between the piping system fluid and the gasket surface. This is particularly important at higher temperatures where oxidizing agents in the piping system become more aggressive. **However, gasket chemical compatibility must still be considered.**
- The Gruvlok Xtreme Lubricant has been formulated from low viscosity, non-petroleum based oils to ease spreading of the lubricant. In applications where pipe movement is expected, proper lubrication of the gasket's exterior assists the gasket into the proper sealing position as pipe system movement occurs. This lubricating film enhances our flexible coupling gasket's ability to compensate for axial, transverse and rotational pipe movements.
- Gruvlok Xtreme Lubricant is the only Gruvlok lubricant that is to be used with Gruvlok couplings and gaskets in HDPE and copper piping systems. Its low temperature capability and lubricity ensure a highly reliable connection.

Gruvlok Xtreme Lubricant is a Teflon® fortified white, tasteless and odorless grease made from Silicone Oil and other ingredients that are safe to ingest.

It is sanctioned by the FDA under C.F.R. 21.172.878 & 21.177.1550 (Incidental Food Contact). It is NSF approved for use with potable water.

CAUTION: Silicone based lubricants are not allowed in some facilities. Teflon® is a registered trademark of Dupont.

Gruvlok Xtreme Lubricant, Gruvlok Quick Dry Lubricant, Gruvlok Lubricant

Gruvlok Quick Dry Lubricant

Gruvlok Quick Dry Lubricant is a fast drying lubricant that has been developed for applications where the piping system is exposed. The service temperature range for this lubricant is from 0° F to 150° F (-17.8°C to 65.6°C) and may be used with all Gruvlok gasket material grades. The lubricant is made from a water emulsion that is non-toxic, it will not impart taste or odor, and does not support bacterial growth. Gruvlok Quick Dry Lubricant is non-corrosive, non-flammable, and is NSF approved for use with potable water.

This lubricant is easy to apply by brush or hand, and it quickly dries to a thin film when in contact with air. It is water-soluble. The quick drying quality of the lubricant eliminates lubricant drips caused by over lubrication. If necessary, reapply lubricant prior to assembly. Do not thin or mix with solvents.

Gruvlok Lubricant

Gruvlok Lubricant is the standard lubricant that has been provided for use with Gruvlok products for years. Gruvlok Lubricant is water soluble, non-toxic, non-corrosive, non-flammable, and will not impart taste or odor. It is NSF approved for use with potable water. This lubricant is acceptable for most applications, however, the Gruvlok Xtreme Lubricant and Gruvlok Quick Dry Lubricant are now available to improve the performance of the couplings and flanges in certain applications.

CAUTION: HDPE pipe requires the use of Gruvlok Xtreme Lubricant and should not be used with Gruvlok Lubricant.

- Introduction
- Couplings
- Outlets
- Fittings
- Valves & Accessories
- High Pressure
- CTS Copper System
- DI-Electric Nipples
- Plain-End Fittings
- HDPE Couplings
- Socket-It® Fittings
- Stainless Steel Method
- Roll Groovers
- Installation & Assembly
- Special Coatings
- Design Services
- Technical Data
- Master Format 3 Part Specs.
- Pictorial Index

Specified Bolt Torque

Specified bolt torque is for the oval neck track bolts used on Gruvlok couplings and flanges. The nuts must be tightened alternately and evenly until fully tightened.

CAUTION: Proper torquing of coupling bolts is required to obtain specified performance. Over torquing the bolts may result in damage to the bolt and/or casting which could result in pipe joint separation. Under torquing the bolts may result in lower pressure retention capabilities, lower bend load capabilities, joint leakage and pipe joint separation. Pipe joint separation may result in significant property damage and serious injury.

NOTE: Use specified bolt torque unless otherwise indicated on product installation pages.

ANSI Specified Bolt Torque			Metric Specified Bolt Torque		
Bolt Size	Wrench Size	Specified Bolt Torque *	Bolt Size	Wrench Size	Specified Bolt Torque *
In.	In.	Ft.-Lbs.	mm	mm	N-m
3/8	11/16	30-45	M10	16	40-60
1/2	7/8	80-100	M12	22	110-150
5/8	1 1/16	100-130	M16	24	135-175
3/4	1 1/4	130-180	M20	30	175-245
7/8	1 7/16	180-220	M22	34	245-300
1	1 5/8	200-250	M24	36	270-340
1 1/8	1 13/16	225-275			
1 1/4	2	250-300			

* Non-lubricated bolt torques

Design Factors

Movement

Each flexible design Gruvlok coupling can provide for pipe system movement up to the design maximum for the specific size and type of coupling being utilized. Movement is possible in the Gruvlok coupling.

due to two factors: (1) designed-in clearance between the key of the coupling and the groove diameter and groove width, and (2) the gap between pipe ends joined by the coupling.

Linear Movement

Flexible Coupling Linear Movement

Linear movement is accommodated within the coupling by allowing the pipe ends to move together or apart in response to pressure thrusts and temperature changes. The available linear movement provided by Standard Gruvlok couplings is shown below:

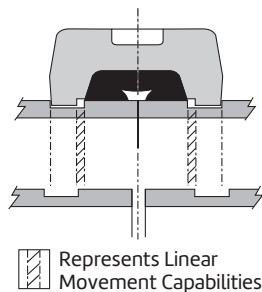

Sizes	Linear Movement	
	Roll Groove Pipe	Cut Groove Pipe
1" through 3 1/2"	1/32"	1/16"
4" though 24"	3/32"	3/16"

Rigid Couplings

Gruvlok rigid couplings Fig. 7400, Fig. 7401 and Fig. 7004 HPR are designed to provide a joint with the attributes of a welded or flanged connection. Therefore, these joints would remain in strict alignment and would resist deflection and linear movement during service.

Angular Movement

Flexible Coupling Angular Movement

Designed-in clearances allow limited deflection of the pipe joint within the coupling, without introducing eccentric loads into the coupling joint.

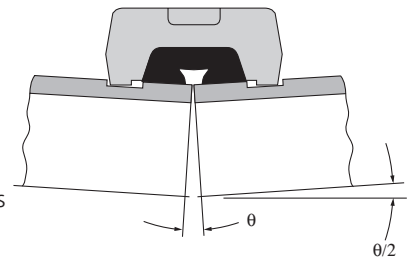

The maximum available angular movement of Gruvlok flexible couplings on roll groove joints is shown in the performance data for each coupling. The amount of angular flexibility varies for each coupling size and type. The values account for pipe, groove, and coupling tolerances.

Flexible Coupling

Figs. 7000, 7001, 7003, 7010 are the flexible couplings provided in the Gruvlok product line. The following information on movement applies to these flexible couplings.

Gruvlok® Flow Control Components Gasket Grade Index & Recommendation

ASC has put together a complete array of Gruvlok components necessary to provide pump protection for HVAC and industrial piping needs. With the combination of the Fig. 7401 Rigidlok and Fig. 7001 Standard coupling, flex connectors can be eliminated thus reducing cost. The Series 7700 Gruvlok® Butterfly valve has superior flow characteristics. The Gruvlok® Series 7800 Check Valve is full waterway valve and can be stacked directly to the Series 7700 Butterfly Valve. The Fig. 7250 Suction Diffuser and Fig. 7260 Tee Strainer complete the Gruvlok® pump protection package.

- | | |
|--------------------------------|-----------------------------------|
| 1. Fig 7001 Flex Coupling HD | 6. Model 758G / 768G Wye Strainer |
| 2. Fig 7402 SlideLOK HD | 7. Model FTV-S Tri-Service Valve |
| 3. Fig. 7788 Flange Adapter | 8. Model FTV-A Tri-Service Valve |
| 4. Fig 7072 Concentric Reducer | 9. Fig 7250 Suction Diffuser |
| 5. Series 7700 Butterfly Valve | 10. Series 7700 Check Valve |

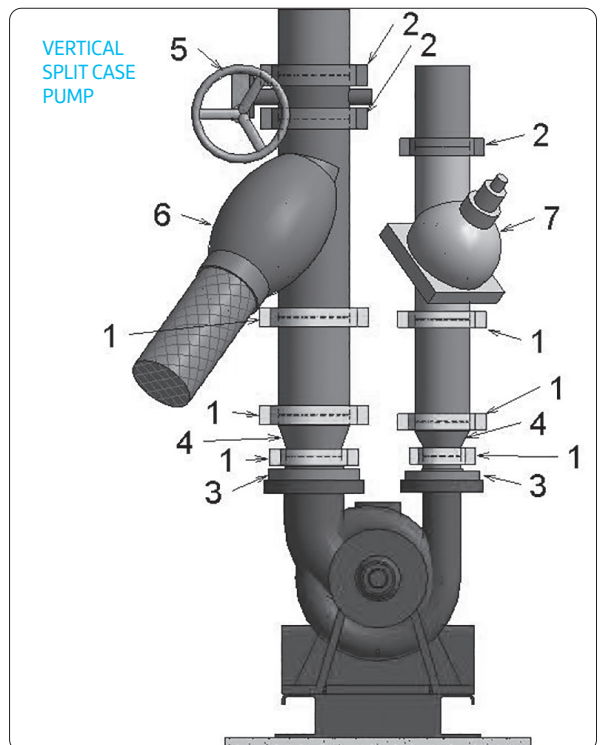
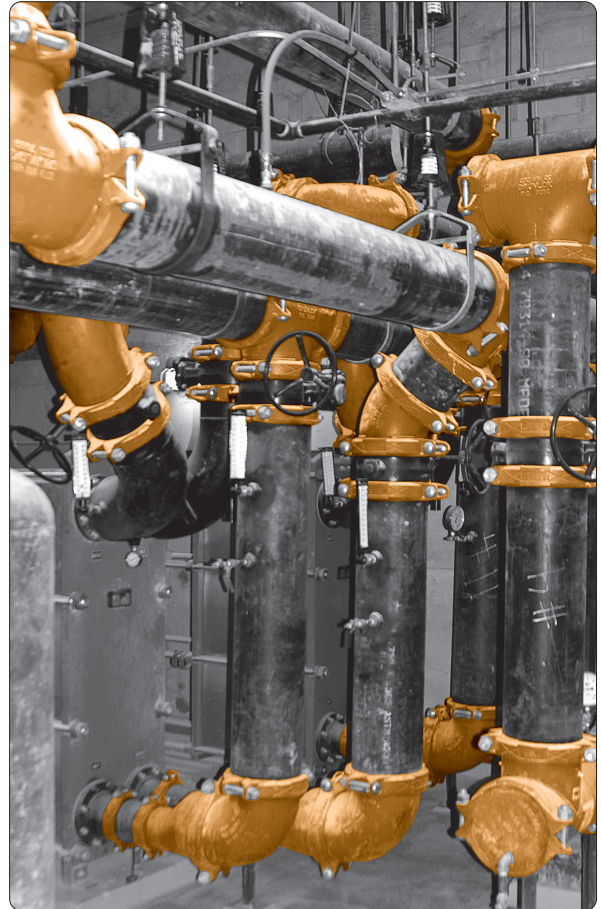
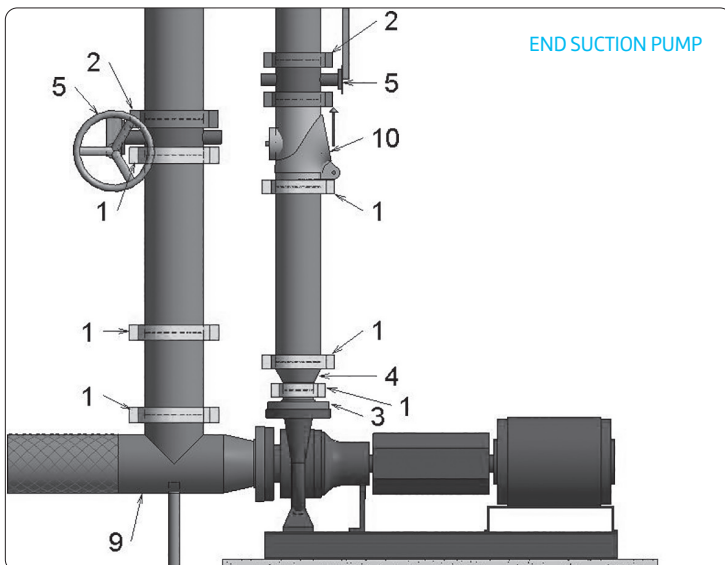
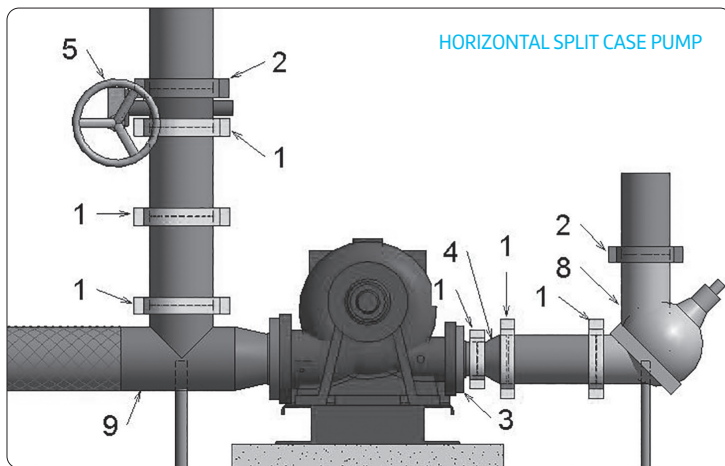

- Introduction
- Couplings
- Outlets
- Fittings
- Valves & Accessories
- High Pressure
- CTS Copper System
- DI-Electric Nipples
- Plan-End Fittings
- HDPE Couplings
- Socket-Fittings
- Stainless Steel Method
- Roll Groovers
- Installation & Assembly
- Special Coatings
- Design Services
- Technical Data
- Master Format 3 Part Specs.
- Pictorial Index

Gruvlok® Gasket Styles

Gruvlok offers a variety of pressure responsive gasket styles. Each serves a specific function while utilizing the same basic sealing concept. Proper installation of the gasket compresses the inclined gasket lips on the pipe O.D., forming a leak tight seal. This sealing action is reinforced when the gasket is encompassed and compressed by the coupling housings. The application of internal line pressure energizes the elastometric gasket and further enhances the gasket sealing action.



“C” Style

The “C” Style cross section configuration is the most widely used gasket. It is the gasket style provided as standard in many Gruvlok Couplings (Fig. 7000, 7001, 7003, 7004HPR, 7307, 7400 and 7401). Grade “E” and “T” are standard grades while other grades are available for special applications.

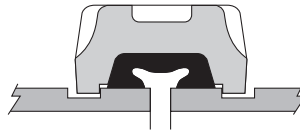

End Guard™

The projecting rib fits between the ends of lined pipe to prevent damage to unprotected pipe ends during coupling joint assembly. The E.G. gasket is provided as standard with the Fig. 7004 E.G. Coupling.

Grade “E” and “T” gaskets are available.

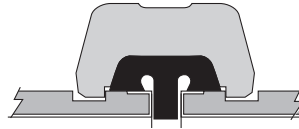

Flush Gap™

Designed to prohibit contaminants from building up in the gasket cavity. The centering rib fits flush over the gap between the two pipe ends thus closing off the gasket cavity. It can be used with Fig. 7000, 7001, 7400 and 7401 Couplings for many applications. Recommended for use in dry fire protection systems.

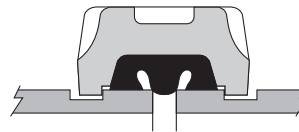

SlideLOK™ Pressure Responsive

SlideLOK gasket patent pending design easily slides over the grooved pipe end for quick installation. The gasket design provides a 360° consistent compression seal when fully installed. The internal ribs are design to prohibit contaminants from building in the gasket cavity by engaging individually with each pipe end.

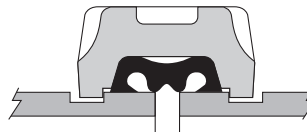

Sock-it®

Used in Sock-It fittings only, this pressure energized gasket provides a leak-tight seal on plain end seal pipe.

Available in Grade “E” material only.

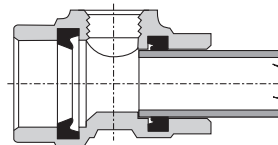

Roughneck®

This “C” style gasket is similar in appearance and design to the Standard gasket but is only used with Fig. 7005 Roughneck Couplings and Fig. 7305 HDPE Couplings. The Roughneck gasket is wider, which allows for minor pipe end separation as line pressure sets the grippers into the plain end pipe.

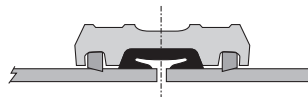

Reducing Coupling

The centering rib allows for pipe positioning and serves to keep the smaller pipe from telescoping during installation. Used only with the Fig. 7010 Reducing Coupling.

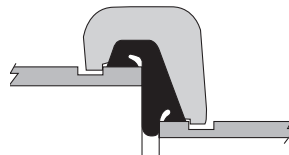

Flange

A specially designed gasket for the Fig. 7012, 7013 and 7312 Flange provides for a reliable seal on both the pipe and the mating flange.

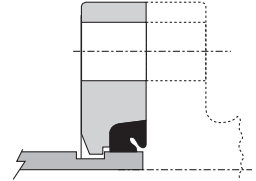

Clamp-T™

These gaskets conform to the curved exterior of the pipe to provide a pressure responsive seal. This unique design is only used with Fig. 7045, 7046 Clamp-T and Fig. 7047, 7048, and 7049 Clamp-T Crosses.

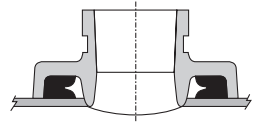

Gasket Grade Index & Recommendation

The lists are provided as an aid in selecting the optimum gasket grade for a specific application to assure the maximum service life. The recommendations have been developed from current information supplied by manufacturers of the elastomers, technical publications, and industry applications. The information supplied should be considered as a basis for evaluation but not as a guarantee.

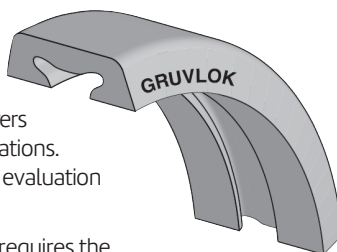

Selection of the optimum gasket grade for a specific service requires the consideration of many factors; primarily temperature, fluid concentration, and continuity of service. Unless otherwise noted, all gasket recommendations are based on 100°F (38°C) maximum temperature service condition. Where more than one gasket grade is shown, the preferred grade is listed first.

Combinations of fluids should be referred to an ASC Engineered Solutions Representative for an engineering evaluation and recommendation. In unusual or severe services, gasket materials should be subjected to simulated service conditions to determine the most suitable gasket grade.

Gasket recommendations apply only to Gruklok gaskets. Contact an ASC Engineered Solutions Representative for recommendations for services not listed. These listings do not apply to Gruklok Butterfly Valves.

All Gruklok products marked with UL/ULC Listed, FM approved VdS and/or LPC symbols are Listed/Approved with EPDM material. For other Listed/Approved materials, please contact an ASC Engineered Solutions for more information.

Gasket Grade Index - Standard Gasket

Grade	Temp. Range	Compound	Color Code	General Service Applications
EP	-40°F to +250°F (-40°C to 121°C)	EPDM	Green and Red	Water, dilute acids, alkalis, salts, and many chemical services not involving hydrocarbons, oils, or gases. Excellent oxidation resistance. NOT FOR USE WITH HYDROCARBONS.
E	-40°F to +230°F (-40°C to 110°C)	EPDM	Green	Water, dilute acids, alkalis, salts, and many chemical services not involving hydrocarbons, oils, or gases. Excellent oxidation resistance. NOT FOR USE WITH HYDROCARBONS.
T	-20°F to +180°F (-29°C to 82°C)	Nitrile (Buna-N)	Orange	Petroleum products, vegetable oils, mineral oils, and air contaminated with petroleum oils. NOT FOR USE IN HOT WATER SERVICES.

Gasket Grade Index - Special Gasket

Grade	Temp. Range	Compound	Color Code	General Service Applications
O	+20°F to +300°F (-7°C to 149°C)	Fluoro Elastomer	Blue	High temperature resistance to oxidizing acids, petroleum oils, hydraulic fluids, halogenated, hydrocarbons and lubricants
L	-40°F to +350°F (-40°C to 177°C)	Silicone	Red Gasket	Dry, hot air and some high temperature chemical services.
E Type A	-40°F to +150°F (-40°C to 66°C)	Pre-Lubricated	Violet	Wet & Dry (oil free air) Pipe in Fire Protection Systems. For dry pipe systems, Gruklok Xtreme™ Temperature Lubricant is required.

Vacuum Service

Size	Vacuum Level	Gasket Recommendation
1" - 12" (25 - 300mm)	0" - 10" Hg	Standard
14" - 16" (350 - 400mm)	0" - 10" Hg	Standard
1½" - 24" (40 - 600mm)	0" - 29.9" Hg	Flush Gap
2" - 8" (50 - 200mm)	0" - 29.9" Hg	SlideLOK

Approved Gasket Applications - Water & Air

Service	Gasket Grade
Air, (no oil vapors) Temp. -40°F to 250°F (-40°C to 121°C)	EP
Air, (no oil vapors) Temp. -40°F to 350°F (-40°C to 177°C)	L
Air, Oil vapor Temp. -20°F to 150°F (-29°C to 66°C)	T
Air, Oil vapor Temp. 20°F to 300°F (-7°C to 149°C)	O
Water, Temp to 150°F (66°C)	E/EP/T
Water, Temp to 250°F (121°C)	EP
Water, Acid Mine	E/T
Water, Chlorine	(E/EP/O)
Water, Deionized	E/EP/T
Water, Seawater	E/EP/T
Water, Waste	E/EP/T
Water, Lime	E/EP/T

Where more than one gasket grade is shown the preferred gasket grade is listed first. Where the gasket grade is shown in parentheses, contact an ASC Engineered Solutions Representative for an engineering evaluation and recommendation.

Specify gasket grade when ordering. Use Gruklok lubricant on gasket. Check gasket color code to be certain it is recommended for the service intended.

Approved Gasket Applications - Petroleum Products

Service	Gasket Grade
Biodiesel	O
Crude Oil - Sour	T
Diesel Oil	T
Fuel Oil	T
Gasoline, Leaded	T
Gasoline, Unleaded*	(O)
Hydraulic Oil	T
JP-3, JP-4 and JP-5	T/O
JP-6, 100°F (38°C) Maximum Temp.	O
Kerosene	T
Lube Oil, to 150°F (66°C)	T
Motor Oil	T
Natural Gas**	T
Tar and Tar Oil	T
Transmission Fluid - Type A	O
Turbo Oil #15 Diester Lubricant	O

Unless otherwise noted, all gasket listings are based upon 100°F (38°C) maximum temperature service conditions.

For services not listed, contact an ASC Representative for recommendation.

* Contact an ASC Representative for service evaluation.

** Extreme caution and care is required when installing Gruklok couplings on a natural gas system.

Must be located in a well ventilated area.

Gasket Grade Index & Recommendation

Chemical Services

Chemical Composition	Gasket Grade
Acetic Acid 50%	E/EP
Acetic Acid Glacial	L/E/EP
Acetone	E/EP
Acethlene	E/EP/T
Alkalis	T/E/EP
Alums	E/EP/T/O
Aluminum Chloride	E/EP/T
Aluminum Fluoride	E/EP/T/O
Aluminum Hydroxide	E/EP/O
Aluminum Nitrate	E/EP/T
Aluminum Salts	E/EP
Ammonia Gas, Cold	E/EP
Ammonia Liquid	E/EP
Ammonium Chloride	T/E/EP
Ammonium Fluoride	E/EP
Ammonium Hydroxide	E/EP
Ammonium Nitrate	T/E/EP
Amyl Acetate	E/EP
Amyl Alcohol	E/EP
Aniline	E/EP
Animal Fats	T
Argon-Gas	L
Arsenic Acid, to 75%	T/E/EP/O
Barium Carbonate	E/EP/T
Barium Chloride	E/EP/T
Barium Hydroxide	E/EP/T
Barium Nitrate	E/EP/O
Barium Sulphide	E/EP/T
Beet Sugar Liquors	T
Benzene	O
Benzene Sulfonic (Aromatic Acid)	(E/EP)
Benzoic Acid	O
Benzyl Alcohol	E/EP
Benzyl Chloride	E/EP
Biodeisel	O
Black Sulphate Liquor	T
Bleach, 5% Active Cl ₂	E/EP/O
Borax	E/EP/O
Boric Acid	E/EP/T
Bromine	O
Butyl Alcohol	E/EP/T
Butyl Stearate	E/EP
Butylene	T/O
Calcium Bisulfate	T/O
Calcium Bisulphide	T/O
Calcium Bisulphite	T/O
Calcium Carbonate	E/EP/T
Calcium Chloride	E/EP/T

Chemical Services

Chemical Composition	Gasket Grade
Calcium Hydroxide (Lime)	E/EP/T
Calcium Sulfate	E/EP/T
Calcium Sulfide	E/EP/T
Caliche Liquors	E/EP/T
Cane Sugar Liquors	T
Carbitol	E/EP/T
Carbon Dioxide, Dry	E/EP/T
Carbon Dioxide, Wet	E/EP/T
Carbon Monoxide	E/EP
Carbon Tetrachloride	O
Castor Oil	T
Caustic Potash	E/EP
Caustic Soda	E/EP
Cellosolve	E/EP
Chlorine Dry	(O)
Chlorinate Solvents	(O)
Chlorobenzene	O
Chlorobenzene Chloride	O
Chlorobromomethane	O
Chloroform	O
Chrome Alum	E/T
Chrome Plating Solutions	O
Chromic Acid, to 50%	O
Citric Acid	E/EP/T
Coconut Oil	T
Cod Liver Oil	T
Coke Oven Gas	T/O
Copper Carbonate	E/EP/T
Copper Chloride	E/EP/T
Copper Cyanide	E/EP/T
Copper Sulphate	E/EP/T
Corn Oil	T
Cotton Seed Oil	T
Cresole, Cresylic Acid	T/O
Creosote, Coal Tar	(T/O)
Creosote, Wood	T/O
Cupric Chloride	E/EP/T
Cupric Fluoride	E/EP/T
Cupric Sulphate	E/EP/T
Cychohexanol	O
Diacetone Alcohol	E/EP
Dichlorobenzene	O
Dichloroethylene	O
Diocetyl Phthalate	(E/EP)
Epson-Salt	E/EP/T
Ethane	E/EP
Ethanolamine	E/EP
Ethyl Acetate	(E/EP)

Chemical Services

Chemical Composition	Gasket Grade
Ethyl Alcohol	E/EP/T
Ethyl-Chloride	E/EP/T
Ethyl Ether	(T)
Ethylene Chloride	E/EP
Ethylene Chlorohydrin	E/EP
Ethylene Diamine	E/EP/T
Ethylene Dichloride (Dichloroethane)	O
Ethylene Glycol	E/EP/T
Ethylene Oxide	(E/EP)
Ferric Chloride, to 35%	E/EP/T
Ferric Nitrate	E/EP/T
Ferric Sulphate	E/EP/T
Ferrous Chloride	E/EP/T
Fish Oils	T
Fluoroboric Acid	E/EP
Fluorosilicic Acid	E/EP
Fly-Ash	E/EP
Formaldehyde	E/EP/T
Formamide	E/EP/T
Formic Acid	E/EP/O
Freon 11, 130°F (54°C) Max.	T
Freon 12, 113, 114, 115, 130°F (54°C) Max.	T
Fructose	T
Furfuryl Alcohol	(E/EP)
Glucose	E/EP/T
Glue	T
Glycerin	E/EP/T
Glycerol	E/EP/T
Glycol	E/EP/T
Heptane	T
Hexaldehyde	E/EP
Hexane	T
Hexylene Glycol	T
Hydrochloric Acid, to 36%, 75°F (24°C)-Max.	E/EP
Hydrochloric Acid, to 36%, 158°F (70°C)-Max.	(O)
Hydrofluoric Acid, to 75%, 158°F (70°C)-Max.	(O)
Hydrofluosilicic Acid	T/E/EP
Hydrogen Peroxide, to 50%	E/EP/T/O
Hydrogen Peroxide, to 90%	(L/O)
Hydroquinone	T/O
Iodine,-Wet	E/EP
Isoamyl Alcohol	E/EP
Isooctane	T
Isobutyl Alcohol	E/EP
Isopropyl Alcohol	E/EP
Lacquer	(O)
Lacquer Solvent	(O)
Lactic Acid	T

Where more than one gasket grade is shown the preferred gasket grade is listed first. Where the gasket grade is shown in parentheses, Contact an ASC Engineered Solutions Representative for an engineering evaluation and recommendation. Check gasket grade when ordering. Use Gruvlok lubricant on gasket.

Unless otherwise noted, all gasket listings are based upon 100°F (38°C) maximum temperature service conditions. For services not listed, Contact an ASC Engineered Solutions Representative for recommendation. Check gasket color code to be certain it is recommended for the service intended.

Gasket Grade Index & Recommendation (Continued)

Chemical Services		Chemical Services		Chemical Services	
Chemical Composition	Gasket Grade	Chemical Composition	Gasket Grade	Chemical Composition	Gasket Grade
Lard Oil	T	Phosphoric Acid, to 75% & 70°F (21°C)-Max.	E/EP/T	Sodium Nitrate	E/EP/T
Latex (1% Styrene & Butadiene)	O	Phosphoric Acid, to 85% & 150°F (66°C) Max.	O	Sodium Peroxide	E/EP
Lead Acetate	E/EP/T	Photographic Solutions	T	Sodium Phosphate	E/EP/T
Linseed Oil	T	Potassium Bromide	E/EP/T	Sodium Silicate	E/EP/T
Lithium Bromide	T/O	Potassium Carbonate	E/EP/T	Sodium Sulphide	E/EP/T
Magnesium Chloride	E/EP/T	Potassium Chloride	E/EP/T	Sodium Sulphite Solution, to 20%	E/EP/T
Magnesium Hydroxide	E/EP/T	Plating Solutions (gold, brass cadmium, copper, lead, silver, tin, zinc)	E/EP	Sodium Thiosulphate, "Hypo"	E/EP/T
Magnesium Nitrate	E/EP	Potassium Chromate	T	Soybean Oil	T
Magnesium Sulphate	E/EP/T	Potassium Cyanide	E/EP/T	Stannous Chloride, to 15%	E/EP/T/O
Malonyl Nitrile	E/EP/T	Potassium Ferricyanide	E/EP/T	Starch	E/EP/T
Mercuric Chloride	E/EP/T	Potassium Ferrocyanide	E/EP/T	Stearic Acid	T
Mercuric Cyanide	E/EP/T	Potassium Hydroxide	T	Styrene	O
Mercury	E/EP/T	Potassium Iodide	E/EP/T	Sucrose Solutions	T
Methyl Acetate	(E/EP)	Potassium Nitrate	E/EP/T	Sulphur	E/EP
Methyl Alcohol, Methanol	E/EP/T	Potassium Permanganate, saturated, to 25%	E/EP	Sulphuric Acid, to 25%, 150°F (66°C)-Max.	E/EP
Methyl Cellosolve (Ether)	E/EP	Potassium Sulphate	E/EP/T	Sulphuric Acid, 25-50%, 200°F (93°C) Max.	O
Methyl Chloride	(O)	Propanol	E/EP	Sulphuric Acid, 50-95%, 150°F (66°C)-Max.	O
Methyl Ethyl Ketone	(E/EP)	Propyl Alcohol	E/EP/T	Sulphuric Acid, Fuming	(O)
Methyl Formate	E/EP	Propylene Glycol	E/EP/T	Sulphuric Acid, Oleum	(O)
Methyl Isobutyl Carbinol	E/EP/T	Pydraul 312C	O	Sulphurous Acid	(O)
Methyl Isobutyl Ketone	(E/EP)	Pyroguard "C" & "D"	T	Tetrachloroethylene	O
Mineral Oils	T	Pyroguard 55	E/EP	Toluene	O
Naphtha, 160°F (71°C)-Max.	O	Pyrrrole	E/EP	Tributyl Phosphate	(E/EP)
Naphthalene 176°F	O	Salicylic Acid	E/EP/T	Triethanolamine	E/EP/T
Nickel Chloride	E/EP/T	Silver Cyanide	E/EP	Trisodium Phosphate	(E/EP/T)
Nickel Nitrate	E/EP	Silver Nitrate	E/EP	Turpentine 158°F (70°C)-Max.	T/O
Nickel Plating Solution 125°F (52°C)-Max.	E/EP	Skydrol, 200°F (93°C)-Max.	L	Urea	E/EP/T
Nitric Acid, to 10%, 75°F (24°C)-Max.	E/EP	Skydrol 500 Phosphate Ester	(L/E/EP)	Vegetable Oils	T
Nitric Acid, 10-50%, 75°F (24°C)-Max.	O	Soda Ash,-Sodium Carbonate	E/EP/T	Vinegar	T
Nitric Acid, 50-86%, 75°F (24°C)-Max.	(O)	Sodium Bicarbonate	E/EP/T	Vinyl Acetate	(E/EP)
Nitric Acid, Red Fuming	(O)	Sodium Bisulphate	E/EP/T	White Liquor	E/EP
Nitro Benzene	(O)	Sodium Bisulphite (black liquor)	E/EP/T	Xylene (Xylol)-158°F (70°C)-Max.	O
Nitrous Oxide	E/EP	Sodium Bromide	E/EP/T	Zinc Sulphate	E/EP/T
Octyl Alcohol	T	Sodium Chlorate	E/EP/T		
Olive Oil	T	Sodium Chloride	E/EP/T		
Oxalic Acid	E/EP	Sodium Cyanide	E/EP/T		
Ozone	E/EP	Sodium Hydroxide, to 50%	E/EP		
Phenol (Carbolic acid) 300°F (149°C)-Max.	O	Sodium Hypochlorite, to 20%	E/EP		
Phenylhydrazine	(O)	Sodium Metaphosphate	E/EP/T		
Phosphate Ester	E/EP				

Where more than one gasket grade is shown the preferred gasket grade is listed first. Where the gasket grade is shown in parentheses, Contact an ASC Engineered Solutions Representative for an engineering evaluation and recommendation. Check gasket grade when ordering. Use Gruvlok lubricant on gasket.

Unless otherwise noted, all gasket listings are based upon 100°F (38°C) maximum temperature service conditions. For services not listed, Contact an ASC Engineered Solutions Representative for recommendation. Check gasket color code to be certain it is recommended for the service intended.

Movement Applications

Thermal Movement

A sufficient amount of coupling joints must be provided to accommodate the calculated movement (expansion or contraction) in a pipe run or segment thereof.

Example:

A 200 foot long straight run of 4" steel cut grooved pipe between anchor points. Minimum Temperature: 40° F (4.4° C) (at time of installation. Maximum Oper. Temperature: 160° F (71.1° C).



Thermal expansion tables show this system will expand a total of 1.80" due to the temperature change.

Design Question

How many couplings are required to account for the thermal growth?

Available Linear Movement per Flexible Coupling:

Using the table on page 274, we see that there is 0.188" linear movement per coupling (4" Flexible Coupling).

Couplings Required

As indicated above, the total movement is 1.80". Thus, the number of couplings is determined as follows:

No. of Couplings = Tot. Movement / Avail. Movement per Coupling

Example:

No. of Couplings = (1.80") / (0.187") = 9.6,
Therefore 10 couplings are needed

Position of Couplings

In order for the couplings to provide for the movement indicated by the above example, it would be necessary to install all couplings with the maximum gap between pipe ends. Conversely, if the thermal movement was contraction due to a reduction of system temperature, the coupling joints would have to be installed with the pipe ends butted, thus accommodating the "shrink" of the pipe system.

In either case the pipe run in question would have to be anchored at the proper locations to direct pipe system expansion or contraction into the coupling joints.

As can be seen from the above example, the pipe end gap within the coupling joint must be considered when designing a grooved end pipe system to accommodate thermal movement. The couplings do not automatically provide for expansion and contraction of piping.

Misalignment & Deflection

The angular movement capability of the Gruvlok coupling permits the assembly of pipe joints where the piping is not properly aligned. At least two couplings are required to provide for lateral pipe misalignment. Deflection (longitudinal misalignment) may be accommodated within a single coupling as long as the angle of deflection does not exceed the value shown in the coupling performance data for the particular size and coupling type.

A pipe joint that utilizes the angular deflection capability of the Gruvlok coupling will react to pressure and thermal forces dependent upon the manner in which it is restrained. An unrestrained joint will react to these forces by straightening, thus reducing, if not eliminating, the deflection at the joint. If joint deflection has been designed into the pipe layout and must be maintained, then sufficient anchors must be provided to resist the lateral forces and hold the joint in the deflected condition.

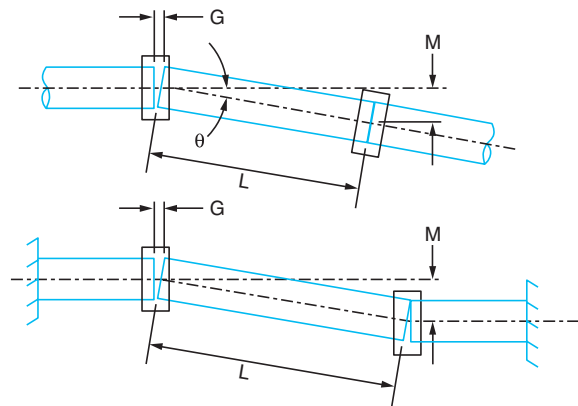

The amount of deflection from pipe run centerline can be calculated utilizing the following equations:

$$M = L (\sin \theta)$$

$$\theta = \text{ArcSin} (G/D)$$

$$M = (G \times L) / D$$

WHERE:

M = Misalignment (inches)

G = Maximum Allowable Pipe End Movement (Inches) as shown under "Performance Data"

θ = Maximum Deflection (Degrees) from centerline as shown under "Performance Data"

D = Pipe Outside Diameter (Inches)

L = Pipe Length (Inches)

Movement Applications (Continued)

Curve Layout

Utilizing the angular deflection at each coupling joint curves may be laid out using straight pipe lengths and Gruvlok Couplings.

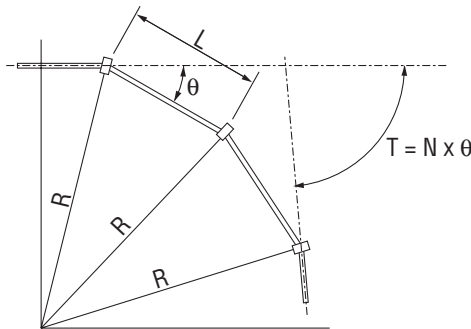

This example shows how to calculate the curve radius, required pipe lengths, and number of required couplings.

$$R = L / (2 \times \sin(\theta/2))$$

$$L = 2 \times R \times \sin(\theta/2)$$

$$N = T / \theta$$

WHERE:

- N** = Number of Couplings
- R** = Radius of Curve (feet)
- L** = Pipe Length (feet)
- θ** = Deflection from centerline (Degrees, Minutes) of each Coupling (See coupling performance data)
- T** = Total Angular Deflection of all Couplings.

Drainage, Buried Systems, Etc.

The flexible design of the Gruvlok coupling makes it ideal for use in a wide variety of systems in which random changes of the pipe direction can be accommodated by the Gruvlok coupling's angular deflection capability rather than requiring the use of special fittings. Pitched drainage systems, buried pipe systems where pipe laying conditions are subject to settlement, and exposed pipe systems laid on rough ground are but a few of the many types of pipe installations that present conditions where the functional capability of the Gruvlok coupling are useful.

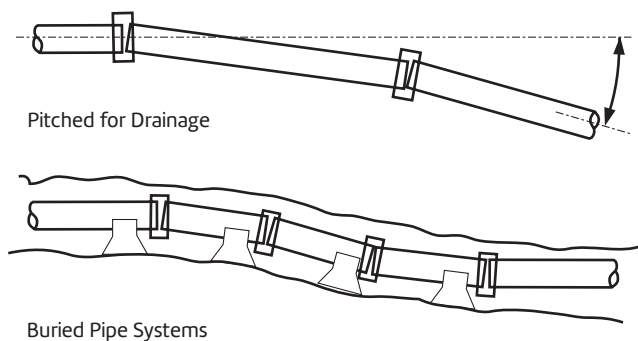

Combined Linear & Angular Movement

The clearance in the grooved coupling joint, will allow a limited capability for combined linear and angular movement. A partially deflected joint will not provide full linear movement capability. A fully deflected coupling joint provides no linear movement capability. The Gruvlok coupling will not allow for both maximum linear and maximum angular movement simultaneously.

In systems where both are expected, additional joints may be required.

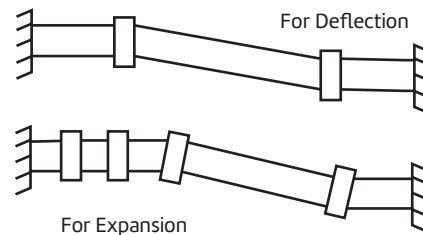

Note: Fully deflected joint will not allow for linear expansion.

In the example above, two couplings were added to account for thermal expansion and the other couplings accommodate only the misalignment.

The additional stress from the combined movement is therefore relieved.

Rotational Movement

Piping systems designed with Gruvlok Couplings can accommodate minor rotational movement from thermal expansion, settlement, vibration, or other similar movements. However, Gruvlok Couplings should never be used as a continuous swivel joint.

Example:

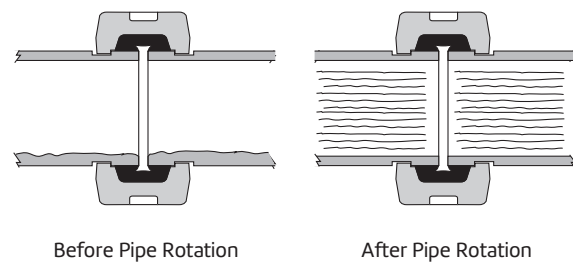

Utilizing the rotational capability of the Gruvlok Coupling, the pipe life of a slurry or similar coarse material piping system can be extended.

For pipe rotation, the system must be shut down and internal pressure relieved.

The pipe may then be rotated one-quarter turn, the couplings re-tightened, and service resumed. If performed on a regular basis, pipe rotation will evenly distribute wear over the entire inner surface of the pipe.

Coupling Working Pressure Rating on Light Wall Roll Grooved Steel Pipe

Gruvlok Coupling Working Pressure Rating (PSI) On Light Wall Roll Grooved Steel Pipe

Nominal Size	O.D.	Nom. Wall Thickness	Pipe Schedule	Maximum Working Pressure (PSI*)											
				Fig. 7000	Fig. 7001	Fig. 7003	Fig. 7004	Fig. 7005	Fig. 7010*	Fig. 7012	Fig. 7013	Fig. 7400	Fig. 7401	Fig. 74/7402	Fig. 70
In./DN (mm)	In./mm	In.	Number	Lightweight	Standard	Hingelok®	High Pressure	Roughneck®	Reducing	Flange	Flange	Rigidlite®	Rigidlok®	SlideLOK®	SlideFLEX®
1 25	1.315 33.4	0.065	5	300	500	-	-	-	-	-	-	175	-	-	-
		0.085	XL	300	300	-	-	-	-	-	-	300	-	-	-
		0.109	10	600	750	-	-	-	-	-	-	300	-	-	-
1¼ 32	1.660 42.2	0.065	5	300	500	-	-	-	-	-	-	175	-	-	-
		0.085	XL	300	300	-	-	-	-	-	-	300	-	-	-
		0.109	10	600	750	-	-	-	-	-	-	300	-	-	-
1½ 40	1.900 48.3	0.065	5	300	500	200	-	-	-	-	-	175	500	-	-
		0.090	XL	300	300	250	-	-	-	-	-	300	300	-	-
		0.109	10	600	750	300	-	-	-	-	-	300	750	-	-
2 50	2.375 60.3	0.065	5	300	500	200	500	-	250	200	500	175	500	-	-
		0.090	XL	300	300	250	300	-	300	300	300	300	300	-	-
		0.109	10	600	750	300	800	500	350	300	720	300	750	600	750
2½ 65	2.875 73.0	0.083	5	300	500	200	500	-	250	200	500	175	500	-	-
		0.130	XL	300	300	250	300	-	300	300	300	300	300	-	-
		0.120	10	600	750	300	800	500	350	300	720	300	750	600	750
3 80	3.500 88.9	0.083	5	300	500	200	500	-	250	200	500	175	500	-	-
		0.130	XL	300	300	250	300	-	300	300	300	300	300	-	-
		0.120	10	600	750	300	800	500	350	300	720	300	750	600	750
3½ 90	4.000 101.6	0.083	5	300	500	-	-	-	-	-	-	-	-	-	-
		0.120	10	600	750	-	-	-	-	-	-	-	-	-	-
4 100	4.500 114.3	0.083	5	300	500	200	400	-	200	200	500	175	500	-	-
		0.120	10	600	750	300	600	400	300	300	720	300	750	500	750
5 125	5.563 141.3	0.109	5	250	400	200	400	-	200	200	400	175	400	-	-
		0.134	10	500	500	250	600	400	300	300	500	300	500	500	-
6 150	6.625 168.3	0.109	5	250	350	150	400	-	200	200	350	175	350	-	-
		0.134	10	400	500	200	500	300	300	300	500	300	500	500	-
		0.188	-	400	500	200	700	-	350	300	500	300	500	-	500
8 200	8.625 219.1	0.109	5	250	300	150	300	-	150	200	300	175	300	-	-
		0.148	10	350	400	200	400	300	250	300	400	175	400	300	400
		0.188	-	350	400	200	500	-	300	300	400	300	400	-	-
10 250	10.750 273.1	0.250	20	350	500	250	600	-	300	300	500	300	500	-	-
		0.134	5	-	250	-	300	-	-	200	250	-	250	-	-
		0.165	10	-	350	-	400	-	-	200	350	-	350	-	-
12 300	12.750 323.9	0.188	-	-	350	-	400	-	-	300	350	-	350	-	-
		0.250	20	-	400	-	500	-	-	300	400	-	400	-	-
		0.156	5	-	200	-	200	-	-	200	200	-	200	-	-
14 350	14.000 355.6	0.188	10	-	350	-	300	-	-	200	350	-	350	-	-
		0.250	20	-	400	-	400	-	-	300	400	-	400	-	-
		0.312	20	-	275	-	-	-	-	250	-	-	275	-	-
16 400	16.000 406.4	0.156	5	-	125	-	-	-	-	125	-	-	125	-	-
		0.250	10	-	250	-	-	-	-	250	-	-	250	-	-
		0.312	20	-	275	-	-	-	-	250	-	-	275	-	-
18 450	18.000 457.2	0.165	5	-	125	-	-	-	-	100	-	-	100	-	-
		0.250	10	-	175	-	-	-	-	175	-	-	175	-	-
		0.312	20	-	275	-	-	-	-	250	-	-	275	-	-
20 500	20.000 508.0	0.250	10	-	100	-	-	-	-	100	-	-	100	-	-
		0.312	20	-	175	-	-	-	-	175	-	-	175	-	-
		0.375	20	-	300	-	-	-	-	250	-	-	250	-	-
24 600	24.000 609.6	0.250	10	-	75	-	-	-	-	75	-	-	75	-	-
		0.375	20	-	300	-	-	-	-	250	-	-	250	-	-

Maximum line pressure, including surge, to which a joint should be subjected on pipe roll grooved to standard roll grooving specification with coupling properly assembled. For coupling performance on standard wall steel pipe, refer to individual Gruvlok Coupling performance listing.

* Rating based on larger pipe size.

Coupling Working Pressure Rating on Roll Grooved ISO Size Steel Pipe

Gruvlok Coupling Working Pressure Rating (Bar) On Roll Grooved ISO Size Steel Pipe

Nominal Size	O.D.	Nom. Wall Thickness	Maximum Working Pressure (bar)									
			Fig. 7000	Fig. 7001	Fig. 7003	Fig. 7004	Fig. 7010*	Fig. 7012	Fig. 7013	Fig. 7400	Fig. 7401	Fig. 74/7402
In./DN(mm)	In./mm	mm	Lightweight	Standard	Hingelok®	High Pressure	Reducing	Flange	Flange	Rigidlite®	Rigidlok®	SlideLOK®
1 25	1.315 33.4	1.8 2.9 3.2	20.7 41.4 41.4	34.5 51.7 69.0	- - -	- - -	- - -	- - -	- - -	12.1 20.7 20.7	- - -	- - -
1¼ 32	1.660 42.2	1.8 2.9 3.6	20.7 41.4 41.4	34.5 51.7 69.0	- - -	- - -	- - -	- - -	- - -	12.1 20.7 20.7	- - -	- - -
1½ 40	1.900 48.3	1.8 2.9 3.6	20.7 41.4 41.4	34.5 51.7 69.0	13.8 17.2 20.7	- - -	- - -	- - -	- - -	12.1 20.7 20.7	34.5 51.7 51.7	- - -
2 50	2.375 60.3	1.8 2.9 3.6	20.7 41.4 41.4	34.5 51.7 69.0	13.8 17.2 20.7	34.5 52.2 82.3	17.2 24.1 24.1	13.8 20.7 20.7	34.5 51.7 69.0	12.1 20.7 20.7	34.5 51.7 51.7	- 41.1 51.7
2½ 65	2.875 73.0	2.0 3.2 5.0	20.7 41.4 41.4	34.5 51.7 69.0	13.8 17.2 20.7	34.5 52.2 82.3	17.2 24.1 24.1	13.8 20.7 20.7	34.5 51.7 69.0	12.1 20.7 20.7	34.5 51.7 51.7	- 41.1 51.7
3 O.D. 76.1	2.996 76.1	2.0 3.2 5.0	20.7 41.4 41.4	34.5 51.7 69.0	- - -	- - -	- - -	13.8 20.7 20.7	- - -	12.1 20.7 20.7	34.5 51.7 51.7	- - -
3 80	3.500 88.9	2.0 3.2 5.6	20.7 41.4 41.4	34.5 51.7 69.0	13.8 17.2 20.7	34.5 52.2 82.3	17.2 24.1 24.1	13.8 20.7 20.7	34.5 51.7 69.0	12.1 20.7 20.7	34.5 51.7 51.7	- 41.1 51.7
3½ 90	4.000 101.6	2.0 3.2 5.6	20.7 41.4 41.4	34.5 51.7 69.0	- - -	- - -	- - -	- - -	- - -	- - -	- - -	- - -
4 100	4.500 114.3	2.0 3.2 5.6	20.7 41.4 41.4	34.5 51.7 69.0	13.8 17.2 20.7	27.6 41.4 82.3	13.8 20.7 24.1	13.8 20.7 20.7	34.5 51.7 69.0	12.1 20.7 20.7	34.5 51.7 51.7	- 34.5 51.7
4¼ O.D. 108.0	4.250 108.0	2.0 3.2 5.6	20.7 41.4 41.4	- - -	- - -	- - -	- - -	- - -	- - -	- - -	- - -	- - -
5 125	5.563 141.3	2.9 3.6 6.3	17.2 34.5 34.5	27.6 34.5 69.0	10.3 13.8 20.7	27.6 41.4 82.3	13.8 20.7 24.1	13.8 20.7 20.7	27.6 34.5 69.0	12.1 20.7 20.7	27.6 34.5 51.7	- 34.5 51.7
5¼ O.D. 133.0	5.236 133.0	2.9 3.6 6.3	17.2 34.5 34.5	- - -	- - -	- - -	- - -	- - -	- - -	- - -	- - -	- - -
5½ O.D. 139.7	5.500 139.7	2.9 3.6 6.3	17.2 34.5 34.5	- - -	- - -	- - -	- - -	13.8 20.7 20.7	- - -	12.1 20.7 20.7	- - -	- - -
6 150	6.625 168.3	2.9 3.6 7.1	17.2 27.6 27.6	24.1 34.5 69.0	10.3 13.8 20.7	27.6 34.5 82.3	13.8 20.7 24.1	13.8 20.7 20.7	24.1 34.5 69	12.1 20.7 20.7	24.1 34.5 51.7	- 34.5 48.3
6¼ O.D. 159.0	6.259 159.0	2.9 3.6 7.1	17.2 27.6 27.6	- - -	- - -	- - -	- - -	- - -	- - -	- - -	- - -	- - -
6½ O.D. 165.1	6.500 165.1	2.9 3.6 7.1	17.2 27.6 27.6	24.1 34.5 69.0	- - -	- - -	- - -	13.8 20.7 20.7	- - -	12.1 20.7 20.7	24.1 34.5 51.7	- - -
8 200	8.625 219.1	2.9 5.0 8.0	17.2 24.1 24.1	20.7 34.5 55.2	10.3 13.8 20.7	20.7 35.4 69	10.3 24.1 24.1	13.8 20.7 20.7	20.7 34.5 55.2	12.1 20.7 20.7	20.7 34.5 51.7	- 20.7 41.4
10 250	10.750 273.1	3.6 5.0 8.0	- - -	17.2 24.1 55.2	- - -	- - -	- - -	13.8 20.7 20.7	17.2 24.1 55.2	- - -	17.2 24.1 51.7	- - -
12 300	12.750 323.9	4.0 5.0 8.0	- - -	17.2 24.1 55.2	- - -	- - -	- - -	13.8 20.7 20.7	17.2 24.1 55.2	- - -	17.2 24.1 51.7	- - -
14 350	14.000 355.6	4.0 6.3 8.8	- - -	8.6 17.2 20.7	- - -	- - -	- - -	8.6 17.2 20.7	- - -	- - -	8.6 17.2 20.7	- - -
16 400	16.000 406.4	4.0 6.3 8.8	- - -	6.9 12.1 20.7	- - -	- - -	- - -	6.9 12.1 20.7	- - -	- - -	6.9 12.1 20.7	- - -
18 450	18.000 457.2	5.0 6.3 8.8	- - -	5.2 6.9 17.2	- - -	- - -	- - -	5.2 6.9 17.2	- - -	- - -	5.2 6.9 17.2	- - -
20 500	20.000 508.0	5.0 6.3 8.8	- - -	3.4 6.9 17.2	- - -	- - -	- - -	3.4 6.9 17.2	- - -	- - -	3.4 6.9 17.2	- - -
24 600	24.000 609.6	5.0 6.3 8.8	- - -	1.7 5.2 17.2	- - -	- - -	- - -	1.7 5.2 17.2	- - -	- - -	1.7 5.2 17.2	- - -

Maximum line pressure, including surge, to which a joint should be subjected on pipe roll grooved to standard roll grooving specification with coupling properly assembled. For coupling performance on standard wall steel pipe, refer to individual Gruvlok Coupling performance listing.
 * Rating based on larger pipe size.

- Introduction
- Couplings
- Outlets
- Fittings
- Valves & Accessories
- High Pressure
- CTS Copper System
- DI-Electric Nipples
- Plan-End Fittings
- HDPE Couplings
- Socket-IT® Fittings
- Stainless Steel Method
- Roll Groovers
- Installation & Assembly
- Special Coatings
- Design Services
- Technical Data
- Master Format 3 Part Specs.
- Pictorial Index

Coupling & Flange Working Pressure Rating on 304 and 316 Stainless Steel Roll Grooved Pipe

The following are pressure ratings for Gruvlok Stainless Steel Piping Systems. The ratings for Schedule 10S pipe are based upon the use of roll-groover roll sets that have been specifically designed for use on Schedule 10 Stainless Steel pipe. Using roll sets that were designed for roll grooving standard wall pipe may significantly reduce the pressure ratings that can be obtained. The Model 1007/3007 roll groovers require the use of the optional Schedule 10 roll set to groove Schedule 5S and 10S. For grooving Schedule 40S on the Model 1007/3007 roll groovers, the standard steel roll grooving set should be used.

Gruvlok Coupling & Flange Working Pressure Ratings (PSI) On 304 And 316 Stainless Steel Roll Grooved Pipe

Nominal Pipe Size	Pipe O.D.	Nominal Wall Thickness	Pipe Sch. Number	Coupling and Flanges															
				Fig. 7000 Lightweight	Fig. 7001 Standard	Fig. 7003 Hingelok®	Fig. 7004 High Pressure	Fig. 7010* Reducing	Fig. 7012 Flange	Fig. 7013 Flange	Fig. 7400 Rigidlite®	Fig. 7401 Rigidlok®	Fig. 7001SS Flexible Coupling	Fig. 7400SS Rigidlite Coupling	Fig. 7401SS Rigid Coupling	Fig. 74 SlideLOK®	Fig. 770 Coupling	Fig. 70 SlideFLEX™	
In./DN(mm)	In./mm	Inches	-	PSI															
1 25	1.315 33.4	0.065	5S	400	400	-	-	-	-	-	-	300	-	325	-	-	-	-	-
		0.109	10S	400	500	-	-	-	-	-	-	300	-	500	-	-	-	-	-
		0.133	40	500	750	-	-	-	-	-	-	300	-	500	-	-	-	-	-
1¼ 32	1.660 42.4	0.065	5S	400	400	-	-	-	-	-	-	300	-	325	275	200	-	-	-
		0.109	10S	500	500	-	-	-	-	-	-	300	-	500	300	300	-	-	-
		0.140	40	500	750	-	-	-	-	-	-	300	-	750	300	600	-	-	-
1½ 40	1.900 48.3	0.065	5S	400	400	275	-	-	-	-	-	300	400	325	275	200	-	-	-
		0.109	10S	500	500	300	-	-	-	-	-	300	500	500	300	300	-	-	-
		0.145	40	500	750	300	-	-	-	-	-	300	750	750	300	600	-	-	-
2 50	2.375 60.3	0.065	5S	250	325	250	325	250	250	275	250	325	225	275	200	-	-	-	-
		0.109	10S	500	500	300	500	500	500	300	300	500	350	300	300	500	500	500	500
		0.154	40	500	750	300	750	500	500	300	300	750	500	300	600	750	750	750	
2½ 65	2.875 73.0	0.083	5S	250	325	250	325	250	250	275	250	325	225	200	200	-	-	-	-
		0.120	10S	500	500	300	500	500	500	300	300	500	350	300	300	500	500	500	500
		0.203	40	500	750	300	750	500	500	300	300	750	500	300	600	750	750	750	
3 80	3.500 88.9	0.083	5S	250	325	250	325	250	250	275	250	325	225	200	200	-	-	-	-
		0.120	10S	500	500	300	500	500	500	300	300	500	350	300	300	400	500	500	500
		0.216	40	500	750	300	750	500	500	300	300	750	500	300	600	500	750	750	
4 100	4.500 114.3	0.083	5S	200	250	200	250	200	200	250	200	250	200	200	200	-	-	-	-
		0.120	10S	300	400	300	400	300	300	300	300	300	400	300	300	350	500	250	325
		0.237	40	500	750	300	750	500	500	300	300	750	325	300	600	400	750		
5 125	5.563 141.3	0.109	5S	125	200	125	200	125	125	200	125	200	125	-	200	-	-	-	-
		0.134	10S	200	300	200	300	200	200	200	300	200	200	-	300	300	-	-	-
		0.258	40	300	500	300	500	300	300	300	300	500	200	-	600	400	-	-	
6 150	6.625 168.3	0.109	5S	75	125	75	125	75	75	125	75	125	125	125	200	-	-	-	-
		0.134	10S	200	200	200	200	200	200	200	200	200	200	250	300	300	350	200	
		0.280	40	300	500	300	500	300	300	300	300	500	200	275	600	400	750		
8 200	8.625 219.1	0.109	5S	50	75	50	75	50	50	75	50	75	50	75	200	-	-	-	-
		0.148	10S	150	200	150	200	150	150	200	150	200	75	150	300	300	350	150	
		0.322	40	300	400	300	400	300	300	300	300	400	200	275	600	400	650		
10 250	10.750 273.0	0.134	5S	-	50	-	50	-	50	50	-	50	-	-	N/R	-	-	-	-
		0.165	10S	-	100	-	100	-	100	100	-	100	-	-	300	-	-	-	
		0.365	40	-	400	-	400	-	300	300	-	400	-	-	600	-	-	-	
12 300	12.750 323.9	0.156	5S	-	75	-	75	-	50	75	-	75	-	-	N/R	-	-	-	
		0.180	10S	-	125	-	125	-	100	125	-	125	-	-	125	-	-	-	
		0.375	40	-	400	-	400	-	300	300	-	400	-	-	300	-	-	-	

Notes:

- 1) Pressure ratings based on ASTM A312 Type 304 stainless steel pipe or equivalent.
- 2) Failure to use Rollers specifically designed for Stainless Steel Pipe may significantly reduce pressure retention capabilities.
- 3) Pressure ratings on cut grooved pipe meet or exceed the schedule 40 pressure ratings listed above. For information regarding higher ratings contact Anvil.
- 4) *For pressure ratings on Figure 7010 Reducing Couplings use larger pipe size.
- 5) For pressure ratings for the reducing tees, concentric reducers and eccentric reducers, use the rating of the weakest end.
- 6) Pressure ratings on schedule 10 stainless steel pipe may be decreased by not using ASC's 1007/3007 roll groovers with the schedule 10 roller set. Contact ASC for details. [For pressure tests exceeding the published load, please contact an ASC Representative.](#)

Coupling Working Pressure Rating on Aluminum Pipe

Gruvlok Coupling & Flange Working Pressure Ratings (PSI) On Aluminum Pipe

Nominal Pipe Size	Pipe O.D.	Wall Thickness	Schedule	R/C	Coupling and Flanges						
					Fig. 7401 Rigidlok®	Fig. 7001 Standard	Fig. 7400 Rigidlite®	Fig. 7000 Light Weight	Fig. 7012 Flange	Fig. 74 SlideLOK®	Fig. 70 Slidefle™
In./DN(mm)	In./mm	Inches	-	-	PSI						
1 25	1.315 33.4	0.179	80	C	-	1000	500	500	-	-	-
		0.133	40	R/C	-	800	500	500	-	-	-
		0.109	10	R	-	600	500	500	-	-	-
		0.065	5	R	-	500	500	500	-	-	-
1¼ 32	1.660 42.4	0.191	80	C	-	1000	500	500	-	-	-
		0.140	40	R/C	-	800	500	500	-	-	-
		0.109	10	R	-	600	500	500	-	-	-
		0.065	5	R	-	500	500	500	-	-	-
1½ 40	1.900 48.3	0.200	80	C	750	1000	500	500	-	-	-
		0.145	40	R/C	750	800	500	500	-	-	-
		0.109	10	R	600	600	500	500	-	-	-
		0.065	5	R	500	500	500	500	-	-	-
2 50	2.375 60.3	0.218	80	C	750	1000	500	500	-	-	-
		0.154	40	R/C	750	800	500	500	250	-	-
		0.109	10	R	600	600	500	500	250	600	600
		0.065	5	R	500	500	500	500	150	-	-
2½ 65	2.875 73.0	0.276	80	C	750	1000	500	500	250	-	-
		0.203	40	R/C	750	800	500	500	250	-	-
		0.120	10	R	600	600	500	500	150	-	-
		0.083	5	R	500	500	500	500	250	-	-
3 80	3.500 88.9	0.300	80	C	750	1000	500	500	250	-	-
		0.216	40	R/C	750	800	500	500	150	-	-
		0.120	10	R	500	600	500	500	150	500	600
		0.083	5	R	400	400	500	500	250	-	-
4 100	4.500 114.3	0.337	80	C	750	800	500	500	250	-	-
		0.237	40	R/C	600	600	500	500	150	600	600
		0.121	10	R	350	350	350	350	250	-	-
		0.083	5	R	250	250	250	250	250	-	-
5 125	5.563 141.3	0.375	80	C	750	800	450	450	150	-	-
		0.258	40	R/C	600	600	450	450	150	-	-
		0.134	10	R	350	300	300	300	250	-	-
		0.109	5	R	250	250	250	250	250	-	-
6 150	6.625 168.3	0.432	80	C	600	600	450	450	150	-	-
		0.280	40	R/C	600	600	450	450	250	400	500
		0.134	10	R	200	200	200	200	250	-	-
		0.109	5	R	200	200	200	200	150	-	-
8 200	8.625 219.1	0.500	80	C	400	400	300	300	150	-	-
		0.322	40	R/C	300	300	150	150	250	500	400
		0.148	10	R	-	-	100	100	250	-	-
		0.109	5	R	-	-	100	100	100	-	-
10 250	10.750 273.0	0.594	80	C	300	300	-	-	250	-	-
		0.365	40	R/C	200	200	-	-	250	-	-
12 300	12.750 323.9	0.688	80	C	300	300	-	-	250	-	-
		0.406	40	R/C	200	200	-	-	250	-	-

Notes:

Field roll grooving is recommended for 6061-T4/6063-T4, 6063 T-5 aluminum pipe.

Field cut grooving is recommended for 6061-T6/6063-T6 aluminum pipe.

Field roll grooving may result in stress cracking.

ASC recommends reviewing roll/cut groove recommendations with the aluminum pipe manufacturer's as mechanical properties may vary from pipe to pipe.

Coupling Working Pressure Rating on CPVC Pipe

Gruvlok Coupling Working Pressure Ratings (PSI) On CPVC Pipe

Nominal Pipe Size	Pipe O.D.	Wall Thickness	Schedule	R (Roll)/C (Cut) Groove	Coupling
					Fig. 7001 Standard
In./DN(mm)	In./mm	Inches	-	-	PSI
2 50	2.375 60.3	0.218	80	C	400
2½ 65	2.875 73.0	0.276	80	C	420
3 80	3.500 88.9	0.300	80	C	370
4 100	4.500 114.3	0.337	80	C	320
6 150	6.625 168.3	0.432	80	C	280
8 200	8.625 219.1	0.500	80	C	250

Temperature Derating Factors on CPVC Pipe

Working Temperature		Pipe De-rating Factor(multiply by pressure rating from chart above)	
°F	°C	Cell Class: CPVC 4120-05	Cell Class: CPVC 4120-06
73-80	23.0-26.7	1.00	1.00
90	32.2	0.91	0.91
100	37.8	0.82	0.83
120	48.9	0.65	0.70
140	60.0	0.50	0.57
160	71.1	0.40	0.44
180	82.2	0.25	0.41

Notes:

1. Cut groove per ASC's CPVC Cut Groove Specification.
2. ASC Recommended Groover: Rex Wheeler 6950 Plastic Cut Groover
3. Pressure ratings based upon Corzan Schedule 80 CPVC Pipe produced to ASTM F441 standards
4. Gruvlok Standard Lubricant is FBC Compatible
5. FBC compliant lubricants are required for use with CPVC Pipe.
6. CPVC pipe manufactured per ASTM F441. Minimum cell class "23447" per ASTM D1784.

Pipe Support

When designing the hangers, supports and anchors for a grooved-end pipe system, the piping designer must consider certain unique characteristics of the grooved type coupling in addition to many universal pipe hanger and support design factors. As with any pipe system, the hanger or support system must provide for:

- 1) the weight of the pipe, couplings, fluid and pipe system components;
- 2) reduce stresses at pipe joints; and
- 3) permit required pipe system movement to relieve stress.

The following factors should be considered when designing hangers and supports for a grooved-end pipe system.

Hanger Spacing

The following charts show the maximum span between pipe hangers for straight runs of standard weight steel pipe filled with water or other similar fluids

Do not use these values where critical span calculations are made or where there are concentrated loads between supports.

Hanger Spacing Linear Movement Not Req'D	
Nominal Pipe Size Range	Maximum Span Between Supports
In./DNmm	Feet/meters
1	7
25	2.1
1¼- 2	10
32-50	3.0
2½ - 4	12
65-100	3.7
5-8	14
125-200	4.3
10-12	16
250-300	4.9
14-16	18
350-400	5.5
18-24	20
450-600	6.1

For straight runs without concentrated loads and where full linear movement is *NOT* required use the table on left.

For straight runs without concentrated loads and where full linear movement *IS* required use the following tables.

Hanger Spacing - Flexible System Steel Pipe, Full Linear Movement Is Req'd Average Hangers Per Pipe Length Evenly Spaced

Nominal Pipe Size Range	Pipe Length in Feet/Meters										
	In.	7	10	12	15	20	22	25	30	35	40
DNmm	2.1	3.3	3.7	4.6	6.1	6.7	7.6	9.1	10.7	12.2	
1-2 25-50	1	2	2	2	3	3	4	4	5	6	
2½- 4 65-100	1	1	2	2	2	2	2	3	4	4	
5-24 125-600	1	1	1	2	2	2	2	3	3	3	

Hanger Spacing - Rigid Systems Suggested Maximum Span Between Supports

Nominal Size	Steel Pipe Suggested Maximum Span Between Supports-Feet/Meters						Copper Tube	
	Water Service			Air Service			Water Service	Gas & Air Service
	*	**	***	*	**	***	**	**
In./DNmm								
1	7	9	12	9	10	12	-	-
25	2.1	2.7	3.7	2.7	3.0	3.7	-	-
1¼	7	11	12	9	12	12	-	-
32	2.1	3.4	3.7	2.7	3.6	3.7	-	-
1½	7	12	15	9	13	15	-	-
40	2.1	3.7	4.6	2.7	4	4.6	-	-
2	10	13	15	13	15	15	9	12
50	3	4	4.6	4	4.6	4.6	2.7	3.6
2½	11	15	15	14	17	15	9	12
65	3.4	4.6	4.6	4.3	5.1	4.6	2.7	3.6
30.D.	11	15	15	14	17	15	-	-
76.1	3.4	4.6	4.6	4.3	5.1	4.6	-	-
3	12	16	15	15	19	15	10	14
80	3.7	4.8	4.6	4.6	5.7	4.6	3	4.2
3½	13	18	15	15	21	15	-	-
90	4	5.4	4.6	4.6	6.3	4.6	-	-
4	14	18	15	17	21	15	12	17
100	4.3	5.4	4.6	5.2	6.4	4.6	3.7	5.1
4¼O.D.	14	18	15	17	19	15	-	-
108.0	4.3	5.4	4.6	5.2	5.7	4.6	-	-
5	16	20	15	20	24	15	13	18
125	4.9	6.0	4.6	6.1	7.3	4.6	4	5.7
5¼O.D.	15	18	15	19	22	15	-	-
133.0	4.6	5.5	4.6	5.2	6.6	4.6	-	-
5½O.D.	16	19	15	20	24	15	-	-
139.7	4.9	5.8	4.6	6.1	7.3	4.6	-	-
6	17	21	15	21	26	15	14	21
150	5.2	6.3	4.6	6.4	7.8	4.6	4.2	6.3
6¼O.D.	16	20	15	20	24	15	-	-
159.0	4.9	6.0	4.6	6.1	7.3	4.6	-	-
6½O.D.	17	21	15	21	25	15	-	-
165.1	5.2	6.3	4.6	6.4	7.6	4.6	-	-
8	19	23	15	24	29	15	-	-
200	5.8	6.9	4.6	7.3	8.7	4.6	-	-
10	19	25	15	24	33	15	-	-
250	5.8	7.5	4.6	7.3	9.9	4.6	-	-
12	23	26	15	30	36	15	-	-
300	7	7.8	4.6	9.1	10.8	4.6	-	-
14	23	26	15	30	37	15	-	-
350	7	7.8	4.6	9.1	11.1	4.6	-	-
16	27	26	15	35	40	15	-	-
400	8.2	7.8	4.6	10.7	12.0	4.6	-	-
18	27	27	15	35	42	15	-	-
450	8.2	8.1	4.6	10.7	12.6	4.6	-	-
20	30	27	15	39	45	15	-	-
500	9.1	8.1	4.6	11.9	13.5	4.6	-	-
24	32	26	15	42	48	15	-	-
600	9.8	7.8	4.6	12.8	14.7	4.6	-	-

* Spacing by ANSI-B31.1 Power Piping Code.

** Spacing by ANSI-B31.9 Building Service Piping Code, (1996 Edition), Fig. 921.1.3c, Table A, 250 psi and Fig. 921.1.3D, table A.

*** Spacing by NFPA-13 Installation of Sprinkler Systems, (1999 Edition), Table 6-2.2.

Pipe Support

Considerations for the Hanging or Supporting of Grooved Piping Systems

Grooved piping products have an excellent maintenance track record out in the field. Whenever there is a “perceived” problem with installed grooved product, a high percentage are often related to the hanging or supporting method or application chosen. Although supported very similarly to welded piping systems, a few considerations should be given to assure the proper selection and application of hangers and supports used on a grooved piping system such as ASC’S Gruvlok® brand.

Review Requirements & Logistics

A variety of hangers and supports are typically used on grooved piping systems, ranging from a simple band hanger, clevis hanger, and trapeze supports to more intricate rack designs using structural steel or a mechanical framing / strut system. All of these are acceptable hanging or supporting methods but they are dependent on the project’s type, design and specification requirements. With this in mind, a vital first step is to refer to the project and code requirements when choosing the proper hanging or supporting method.

Project logistics is another consideration regardless of system type. Quite often hangers and supports are an afterthought on a project simply because the big-ticket items, such as labor, major equipment and schedule, are the focus of the project team. However, hangers and supports are one of the first components needed on a project since you cannot hang pipe without them.

In nearly every hanger or support assembly there are three components that make up the assembly. These components are an upper attachment (beam or structural attachment), intermediate attachment (rod, couplings, eye nuts, etc.) and the lower attachment (pipe clamps, U-bolts, trapezes). See accompanying illustrations for examples of typical assemblies. All three components should arrive on the project site together and early. To save costly field labor hours, consideration might be given to having the hangers or supports pre-assembled by the manufacturer or fabricated in the contractor’s shop. Components can also be bundled and tagged by system or area of the project so they can be easily assembled and located on-site.

Make a Match

The type of grooved coupling used on a project is the next consideration to choosing the correct hanger or support method. The proper maximum spacing allowables governed by project specifications, the applicable code and/or the hanger manufacturer’s recommendations all must also be reviewed. Flexible couplings used on horizontal runs of pipe need to be supported at every coupling and usually require intermediate supports to satisfy the maximum spacing allowable requirements. Rigid couplings, on the other hand, can be hung or supported based on the maximum spacing requirements only. In addition, wherever there is a change in direction of the piping system a hanger or support is usually required immediately following that change in direction and then the system is hung or supported accordingly.

Pressure Point

System pressurization should also be reviewed when choosing the proper hanging or support method. As the couplings are installed, the pipe ends can either be butted up tight to one another or a gap can exist. Once the system is pressurized, those areas or joints where the pipe ends are butted up tight and held by a grooved coupling can “pop” or grow to the maximum gap depending on the coupling chosen. The joint at a flexible grooved coupling can expand about ¼" at each coupling whereas the joint at a rigid grooved coupling can grow about ⅜". If there is a long run of horizontal or vertical pipe with multiple joints the overall length of the system will grow depending upon which grooved coupling you have chosen.

For example, if you have a grooved piping system that is 400 ft. long there will be roughly 19 grooved joints (assuming 21 ft. lengths of pipe are used). If you multiply the number of joints by the growth of each joint you can determine the overall growth of the system due to pressurization. If it is a flexible system, 19 joints x .25" = 4.75" of overall growth. A rigid system would be 19 joints x .0938" = 1.78" of overall growth.

As one can see, this growth due to pressurization can have a significant impact on the hangers or supports used on a project. One way to avoid this growth is to install the grooved joints at full gap so that pressurization has no impact at testing or start up. If this is not possible, then periodic air pressurization as the system is installed will expand the grooved joints to full gap and the hangers or supports can be adjusted accordingly.

Hot & Cold

Thermal expansion is another important consideration when choosing hangers or supports for a grooved system. This is especially important on hot systems versus chilled systems since the amount of thermal expansion will be greater on hot systems as opposed to the thermal contraction that will occur on chilled systems. This is all due to the temperature variation from ambient conditions when the pipe is installed to operating conditions.

For example, if you again take 400 ft. of grooved piping, let us assume the system is heating hot water that will operate at 170°F. The pipe is installed under ambient conditions assumed to be at 70°F so you have a 100°F variation in temperature. At 70°F the pipe has a coefficient of thermal expansion of 0.0 in/ft but at 170°F the pipe has a coefficient of thermal expansion of 0.0076 in/ft. To determine the total thermal expansion of the pipe from ambient temperature to operating temperature you multiply the length of pipe by the coefficient of thermal expansion. In this case: 400 ft. x 0.0076 in/ft. = 3.04 in. In other words the pipe has grown in length over 3 inches because of the thermal expansion.

This is significant growth especially if there is a change of direction at the end of the 400 ft. pipe run or there are branch lines coming off the main run. If this thermal growth exceeds the allowable deflection of a grooved joint, especially where a change of direction or a branch line connects, then problems could occur.

Pipe Support Considerations for the Hanging or Supporting of Grooved Piping Systems

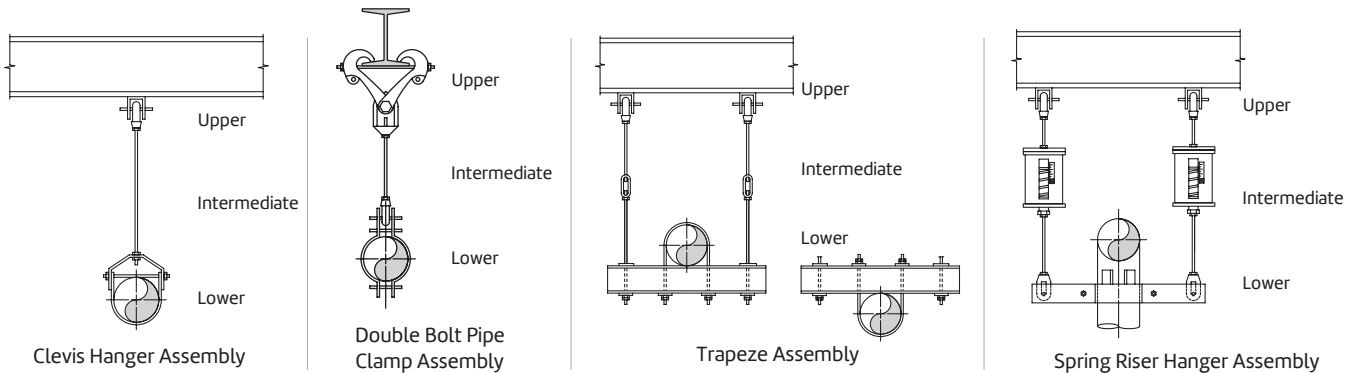

Thermal growth cannot be stopped. It can only be controlled by the use of anchors and expansion joints or expansion loops.

It is also important to hang or support the pipe with rolls or slides and use guides to control the thermal expansion of the pipe into an expansion joint or expansion loop. The use of static hangers, such as clevis hangers, should not be considered on pipe that is thermally expanding. When using trapeze hangers for multiple systems it is important to have "like" systems on the trapeze, that is, systems that are operating near the same temperature. If you combine hot systems with cold systems on a trapeze, the thermal expansion of the hot system can cause the trapeze to possibly twist and fail or excessive stress could be induced on the grooved joints on all of the systems on the trapeze. Hot systems should be hung or supported independently of cold or ambient systems or a means should be provided, such as pipe rolls or pipe slides, to allow the hot systems to thermally expand on the trapeze.

If the pipe is a vertical riser then consideration must be given to the use of spring hangers to allow the pipe to grow vertically up or down depending upon how the pipe is anchored while still supporting the pipe. Vertical pipe thermally expands the same amount as horizontal pipe and this has to be taken into consideration relating to supports, expansion joints or expansion loops. If the vertical pipe is supported by friction/riser clamps only and the pipe expands vertically upward, the clamps will grow with the pipe off the penetration or supporting structure and no longer provide support. If the growth is downward, the friction clamps resting on the penetration or supporting structure can either fail or the pipe may overcome the friction force and push it's way through the clamp as the pipe thermally expands downward. In either case the clamps are no longer supporting the pipe as intended and this may induce excessive stress on the grooved joints.

Whether it is horizontal or vertical grooved pipe, growth of the piping system due to pressurization and thermal expansion must be considered. On hot systems, both must be taken into account and added together to determine the overall growth of the system and the effect on the hangers or supports that are used. In the previous examples, pressurization expansion on the 400 ft. run of pipe was 4.75" for a flexible joint system and 1.78" for a rigid joint system and the thermal expansion was 3.04". Adding these combinations together would result in a total pipe growth of 7.79" for a flexible system or 4.82" for a rigid system, regardless of the horizontal or vertical orientation of the pipe. Again, this is a significant amount of growth relating to hangers and supports and the resulting stresses induced on grooved joints.

Consider Some Restraint

Although grooved systems in seismic zones perform extremely well, consideration should be given to how a grooved system is seismically restrained. If you have growth due to pressurization and /or thermal expansion consideration should be given on how to restrain the system while still allowing growth to occur. Seismic restraints in the longitudinal direction of a long pipe run may restrict the growth of the pipe inducing stresses into the grooved couplings. Seismic restraints in the lateral direction should have little impact on expansion except where the system has a change in direction. If the seismic restraints are placed laterally after a change in direction at the end of a long run of pipe, the expansion of the long pipe run may be restricted and this could induce excessive stress into the grooved joints.

By reviewing the couplings to be used on a project, pressurization, thermal expansion and seismic restraints, one can best determine the proper selection and application of hangers and supports for a grooved piping system. This will, in turn, help ensure that grooved piping systems will continue to enjoy a solid reputation in the areas of maintenance and downtime.

Coupling Flexibility

The grooved coupling's capability to allow angular and rotational movement within the coupling joint must be considered when deciding hanger and support locations. Spring hangers and supports providing for movement in more than one plane are often used to allow the pipe system to move without introducing additional stress into the pipe system.

Example 1

This example demonstrates the need for each pipe length in a grooved system to be supported. The sag due to the flexibility of the Gruvlok joint could be eliminated with the proper positioning of hangers on both pipe segments "L1" and "L2".

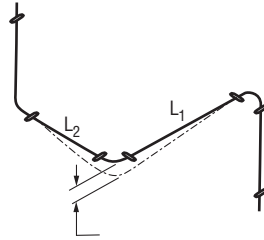

Example 2

This illustrates the effect of pump oscillation on a piping system. A spring hanger should be used to support the pipe section and also respond to the induced vibrations. The couplings in the horizontal run above the riser, should accommodate the deflection without transmitting bending stresses through the pipe system.

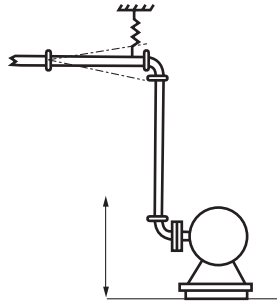

Pressure Thrusts

Gruvlok couplings react to the application of system pressure and restrain the pipe ends from separation due to the pressure force. However, the coupling joint may not be in the self-restraining configuration prior to the application of system pressure. The Gruvlok coupling does not restrain adjacent pipe sections from separation due to pressure forces until the coupling key sections engage the groove walls.

Random flexible coupling joint installation will produce installed coupling conditions ranging from pipe ends full butted to fully separated to the maximum available gap. Thus, only after system pressurization will the self-restraining function of the coupling be in effect.

The designer must account for the movement to be encountered when the system is pressurized and the joints are fully separated. Anchor and guide positions must be defined to direct the pipe joint movement that it is not detrimental to the pipe system.

Examples of the effect of pressure thrust are shown in the following illustrations.

Example 1

The coupling joints have been installed butted or partially open. When pressurized the pipe ends in the coupling joints will separate to the maximum amount permitted by the coupling design.

The coupling key sections will make contact with the groove walls and restrain the pipe from further separation.

The movement at each coupling joint will add with all other joints and produce ΔL .

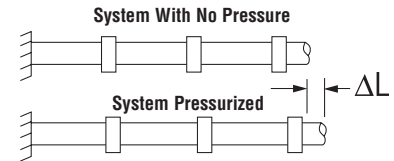

Example 2

In the system shown here, the pipe will move and deflect at the elbow joint due to pressure thrust.

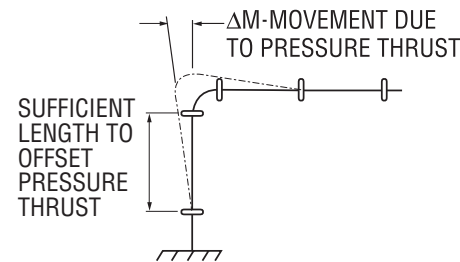

The pipe designer must assure himself that the system has the capability of deflecting sufficiently to absorb this movement without introducing additional stresses into the pipe system. In the deflected condition shown, temperature increases would produce further expansion of the pipe system thus increasing the deflection.

Example 3

To restrain this system provide a pressure thrust anchor at "R1" to resist the pressure thrust acting through the tee "D1" at the cap "C". Provide a hanger at Point "R2", or a base support at Point "D2" to support the vertical column.

If the offsets L1, L2, and L3 are of adequate length to handle expected pipe movements, no additional anchoring is required. Thermal movement of the pipe system should also be considered, and intermediate anchors located as required, to direct the pipe movement so as to prevent introducing bending stresses into the system.

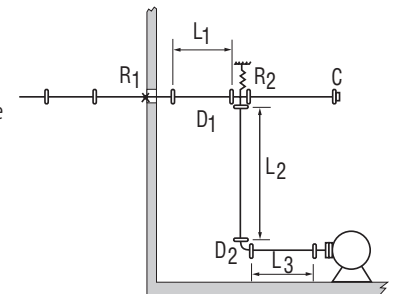

Coupling Flexibility (Continued)

Example 4

Anchor at "A" to support weight of vertical water column. Use spring hanger at "D" and "E" to allow movement of vertical piping. Anchors at "B" and "C" if offsets at L1 and L2 are insufficiently long to handle expected pipe movements.

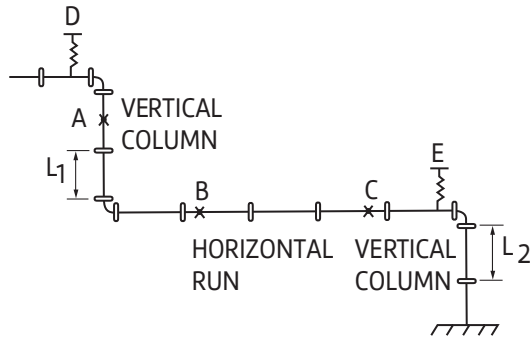

Lateral Restraint

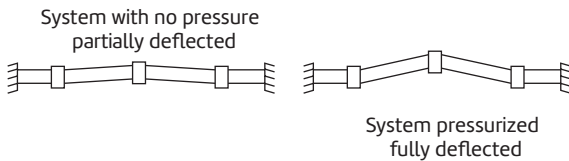

Example 5

A grooved coupling joint installed in a partially deflected condition between anchor locations will deflect to its fully deflected condition when pressurized. Hangers and supports must be selected with consideration of the hanger's capability to provide lateral restraint.

Light duty hangers, while acceptable in many installations, may deflect against the application of lateral forces and result in "snaking" conditions of the pipe system.

Riser Design

Risers assembled with Gruvlok Flexible couplings are generally installed in either of two ways. In the most common method, the pipe ends are butted together within the coupling joint. Note that when installing risers, the gasket is first placed onto the lower pipe and rolled back away from the pipe end prior to positioning the upper pipe. Anchoring of the riser may be done prior to pressurization with the pipe ends butted or while pressurized, when, due to pressure thrust, the pipe ends will be fully separated.

An alternative method of riser installation is to place a metal spacer of a predetermined thickness, between the pipe ends when an additional length of pipe is added to the riser stack. The upper pipe length is anchored, the spacer removed and the coupling is then installed. This method creates a predetermined gap at each pipe joint which can be utilized in pipe systems where thermal movement is anticipated and in systems with rigid (threaded, welded, flanged branch connections where shear forces due to pressure thrust could damage the rigid connections.

The following examples illustrate methods of installing commonly encountered riser designs.

Risers without Branch Connections

Install the riser with the pipe ends butted.

Locate an anchor at the base of the riser (A) to support the total weight of the pipe, couplings and fluid. Provide pipe guides on every other pipe length, as a minimum, to prevent possible deflection of the pipe line at the coupling joints as the riser expands due to pressure thrust or thermal growth. Note that no intermediate anchors are required.

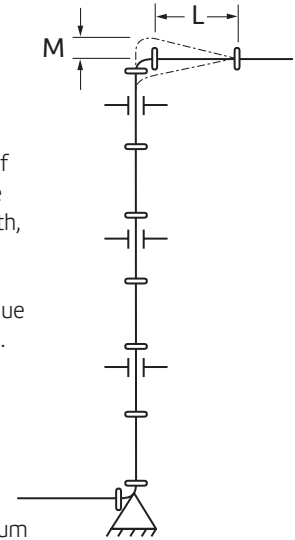

When the system is pressurized the pipe stack will "grow" due to the pressure thrust which causes maximum separation of pipe ends within the couplings. The maximum amount of stack growth can be predetermined (see Linear Movement). In this example the pipe length "L" at the top of the riser must be long enough to permit sufficient deflection (see Angular Movement) to accommodate the total movement "M" from both pressure thrust and thermal gradients.





Risers with Branch Connections

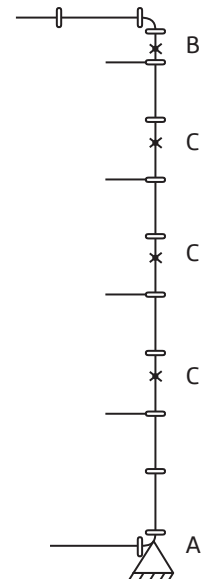





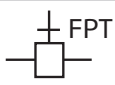
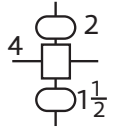
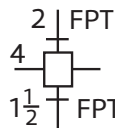
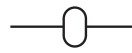

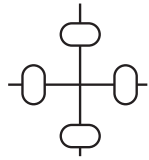
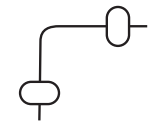
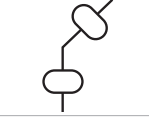
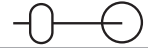
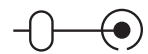
Install the riser with the predetermined gap method. Anchor the pipe at or near the base with a pressure thrust anchor "A" capable of supporting the full pressure thrust, weight of pipe and the fluid column. Anchor at "B" with an anchor capable of withstanding full pressure thrust at the top of the riser plus weight of pipe column. Place intermediate anchors "C" as shown, between anchors "A" and "B". Also place intermediate clamps at every other pipe length as a minimum.

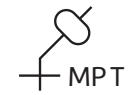
When this system is pressurized, the pipe movement due to pressure thrust will be strained and there will be no shear forces acting at the branch connections.

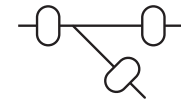
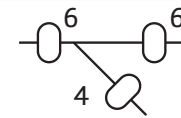
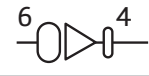

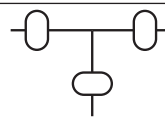
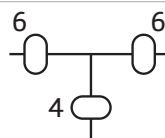
Drafting Symbols For Gruvlok® Piping Systems

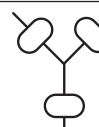
COMPONENT	FIG. NO.	SYMBOL
BULL-PLUG	7075	
CAP	7074	
CLAMP-T		
GROOVED OUTLET	7046	
FEMALE THREADED OUTLET	7044 7045	
CLAMP-T-CROSS		
GROOVED OUTLETS	7048	
FEMALE THREADED OUTLETS	7047	
COUPLINGS		
STRAIGHT	7000 7001 7003 7004 7011 7400 7401	
REDUCING	7010	
CROSS	7068	
ELBOW		
90°	7050	
45°	7051	
TURNED-DOWN	-	
TURNED-UP	-	

COMPONENT	FIG. NO.	SYMBOL
ELBOW		
90° ADAPTER	7055	
45° ADAPTER	7056	
EXPANSION JOINT	7092	
GRUVLOK FLANGE	7012 7013	
LATERAL 45°		
STRAIGHT	7069	
REDUCING	7070	
REDUCER		
CONCENTRIC	7072	
ECCENTRIC	7073	
TEE		
STRAIGHT	7060	
REDUCING	7061	
TURNED-DOWN	-	
TURNED-UP	-	
TRUE-WYE	7071	
GRUVLOK	SERIES	
BUTTERFLY	7700	
BALL VALVE	7500	
CHECK VALVE	7800	

All fittings are shown with couplings attached at the grooved-ends.

Pipe-Preparation

To create a Gruvlok pipe joint, all pipe must be prepared to receive a Gruvlok coupling or other Gruvlok pipe system components. Required pipe preparations may include: grooving or cleaning the pipe ends, or cutting a hole in the pipe wall.

For grooved-end joints, pipe may be grooved by either of two methods; cut or roll grooving. Branch outlet connections require a properly sized and correctly located hole to be cut into the pipe. Sock-it connections require cleaning of the pipe end. Gruvlok plain-end pipe couplings require that the pipe be free of burrs

and other sharp projections which could damage the gasket; grooving is not required.

Gruvlok pipe grooving and hole cutting machines are available in a wide variety of designs to meet specific or general requirements. Gruvlok roll grooving machines produce a groove to proper dimensional tolerances, concentric with the pipe O.D., even on out-of-round pipe. Gruvlok hole cutting tools properly center holes for correct assembly of Gruvlok branch outlet components.

Cut Grooving

Cut grooving is intended for use with standard and heavier wall pipe. Cut grooving produces a groove in the pipe wall by removing metal from the pipe O.D. The groove removes less than one half of the pipe wall and does not cut as deeply into the pipe wall as do standard pipe threads. The square cut edge of the groove allows for the full expansion, contraction, and deflection capabilities of the Gruvlok coupling.

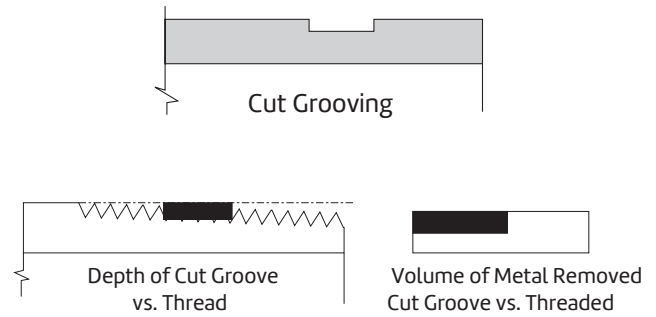

Roll Grooving

Roll grooving does not remove metal. Instead, metal is displaced while a groove is formed into the outer surface of the pipe wall. The groove configuration has slightly rounded edges resulting in a less flexible joint than a cut groove joint. This reduces available pipe joint movement by 50% over cut grooved coupling joints. Roll grooving is commonly used on a wide range of pipe thicknesses up to 0.375" wall steel pipe and sizes to 24" O.D.

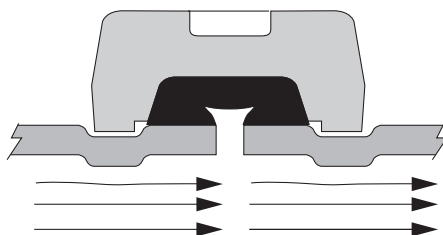

The I.D. "dimple" formed from roll grooving reduces the I.D. (on an average) less than 2%.

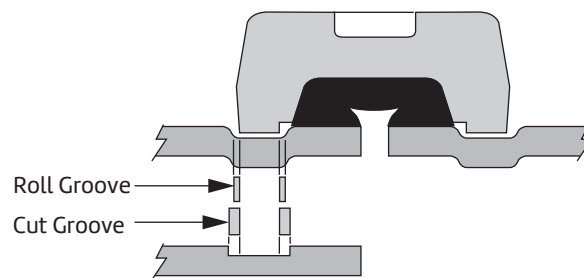
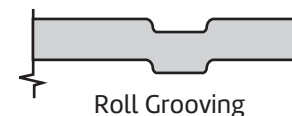

Available Movement
Roll Groove vs. Cut Groove

Pipe-Preparation

Branch Outlet Pipe Clamp: Clamp-T®

Clamp-T installations require the cutting of a hole through the pipe wall. The hole must be properly sized and located on the centerline of the pipe to assure reliable performance of the Clamp-T gaskets.

After the hole has been cut into the pipe wall, any burrs and sharp or rough edges must be removed from the hole. The outside pipe surfaces within $\frac{5}{8}$ " of the hole must be clean and smooth.

Any scale, projections or indentation which might effect the gasket sealing on the pipe must be removed. The surface around the entire circumference of the pipe within the "A" dimension in the charts must be free from dirt, scale, or projections which might effect the proper assembly of the Clamp-T.

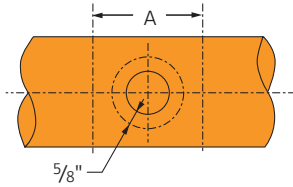

Sock-It®

For Sock-It Fittings, the pipe ends must be square cut as measured from a true square line.

The maximum allowable tolerance is 0.030" (0.76mm) for all sizes. Any sharp edges, burrs, etc. left on the pipe from cutting must be removed. If these are not removed, they may damage the gasket as the pipe is inserted into the Sock-It Fitting.

After cutting, pipe ends must be completely cleaned a minimum of 1" (25.4mm) back from the pipe end to remove all pipe coating, weld beads, rust, sharp projections, etc., which might effect gasket sealing integrity.

Pipe Tolerances

Size	Schedule 10 & 40		Min. O.D.	XL Min. O.D.
	Nom O.D.	Max. O.D.		
DN/mm	In./mm	In./mm	In./mm	In./mm
1	1.315	1.325	1.295	1.285
25	33.4	33.6	32.9	32.6
1¼	1.660	1.670	1.642	1.630
32	42.2	42.4	41.7	41.4
1½	1.900	1.910	1.882	1.875
40	48.3	48.5	47.8	47.6
2	2.375	2.385	2.357	2.352
50	60.3	60.6	59.9	59.7
2½	2.875	2.904	2.846	2.837
65	73.0	73.8	72.3	72.1

NOTE: When Allied XL pipe is used it is necessary only to remove sharp edges and burrs at the end of the pipe. No additional cleaning is required.

The sharp O.D. edge left by different methods of cutting pipe *must be removed*. If this sharp edge is not removed, it may damage the gasket as the pipe is inserted into the Sock-It Fitting.

Roughneck®:

Plain-End pipe for use with Fig. 7005 Roughneck Couplings must be free of any notches, bumps, weld bead, score marks, etc. for at least 1½" (38 mm) back from the pipe end to provide a smooth sealing surface for the gasket. Pipe ends (plain or beveled end) must be square cut as measured from a true square line with the maximum allowable tolerance as follows: 0.030" (0.7 mm) for 2" through 3"; 0.045" (1.1 mm) for

Branch Size	Hole Dimensions		Surface Prep. "A"
	Hole Saw Size	Max. Perm. Diameter	
	DN/mm	In./mm	
1/2, 3/4, 1	1½	1⅝	3½
15, 20, 25	38.1	41.3	88.9
1¼, 1½	2	2⅛	4
32, 40	50.8	54.0	101.6
2	2½	2⅝	4½
50	63.5	66.7	114.3
2½	2¾	2⅞	4¾
65	69.9	73.0	120.7
3	3½	3⅝	5½
80	88.9	92.1	139.7
4	4½	4⅝	6½
100	114.3	117.5	165.1

Acceptable Pipe End Configuration

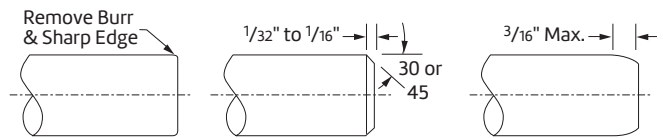
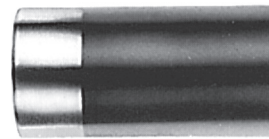

Square cut pipe with O.D. burr & sharp edge removed is preferred configuration.

Beveled pipe. Bevel not to exceed 1/16".

Soft pipe when roll cut may be swaged inward. Swaged portion not to exceed 3/16"

Unacceptable

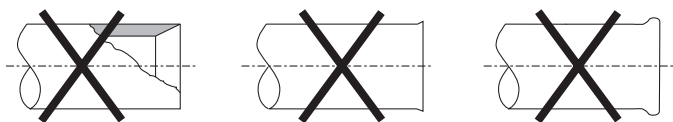

Excessive chamfer on I.D. will tend to cut gasket during assembly.

Abrasive wheels & saws leave edge burrs especially pronounced on one side.

Dull wheel cutter produces a raised ridge at the pipe O.D. giving an oversize diameter.

4" through 6"; and 0.060" (1.5 mm) for 8" sizes. The nominal outside diameter of pipe should not vary more than ±1% for sizes up to 2½", +1% - 1/32" for sizes 3"-5"; +1/16" - 1/32" for sizes 6" and larger. Pipe ends must be marked a distance of 1" from the pipe end for Sizes 2"-4" and 1¼" from the pipe end for Sizes 5"-8" as a guide for centering of the gasket on the pipe ends.

Roll Groove Specification

Gruvlok Standard Roll Groove Specification or Steel & Other IPS Or ISO Size Pipe

Nominal Pipe Size	O.D.		"A" ±0.030/ ±0.76	"B" ±0.030/ ±0.76	"C" Actual	"C" Tol. +0.000	"D" (Ref. Only)	"T" Min. Allow. Wall Thick	Max. Flare Dia.
	-1-	-2-							
	Actual	Tolerance							
In./DN(mm)	In./mm	+In./mm -In./mm	In./mm	In./mm	In./mm	-In./mm	In./mm	In./mm	In./mm
1	1.315	+0.015 -0.015	0.625	0.281	1.190	-0.015	0.063	0.065	1.430
25	33.4	+0.38 -0.38	15.88	7.14	30.23	-0.38	1.60	1.7	36.3
1½	1.660	+0.016 -0.016	0.625	0.281	1.535	-0.015	0.063	0.065	1.770
32	42.2	+0.41 -0.41	15.88	7.14	38.99	-0.38	1.60	1.7	45.0
1½	1.900	+0.019 -0.019	0.625	0.281	1.775	-0.015	0.063	0.065	2.010
40	48.3	+0.48 -0.48	15.88	7.14	45.09	-0.38	1.60	1.7	51.1
2	2.375	+0.024 -0.024	0.625	0.344	2.250	-0.015	0.063	0.065	2.480
50	60.3	+0.61 -0.61	15.88	8.74	57.15	-0.38	1.60	1.7	63.0
2½	2.875	+0.029 -0.029	0.625	0.344	2.720	-0.018	0.078	0.083	2.980
65	73.0	+0.74 -0.74	15.88	8.74	69.09	-0.46	1.98	2.1	75.7
3 O.D.	2.996	+0.030 -0.030	0.625	0.344	2.845	-0.018	0.076	0.083	3.100
76.1	76.1	+0.76 -0.76	15.88	8.74	72.26	-0.46	1.93	2.1	78.7
3	3.500	+0.035 -0.031	0.625	0.344	3.344	-0.018	0.078	0.083	3.600
80	88.9	+0.89 -0.79	15.88	8.74	84.94	-0.46	1.98	2.1	91.4
3½	4.000	+0.040 -0.031	0.625	0.344	3.834	-0.020	0.083	0.083	4.100
90	101.6	+1.02 -0.79	15.88	8.74	97.38	-0.51	2.11	2.1	104.1
4¼ O.D.	4.250	+0.042 -0.031	0.625	0.344	4.084	-0.020	0.083	0.083	4.350
108.0	108.0	+1.07 -0.79	15.88	8.74	103.73	-0.51	2.11	2.1	110.5
4	4.500	+0.045 -0.031	0.625	0.344	4.334	-0.020	0.083	0.083	4.600
100	114.3	+1.14 -0.79	15.88	8.74	110.08	-0.51	2.11	2.1	116.8
5¼ O.D.	5.236	+0.052 -0.031	0.625	0.344	5.084	-0.020	0.076	0.109	5.350
133.0	133.0	+1.32 -0.79	15.88	8.74	129.13	-0.51	1.93	2.8	135.9
5½ O.D.	5.500	+0.055 -0.031	0.625	0.344	5.334	-0.020	0.083	0.109	5.600
139.7	139.7	+1.40 -0.79	15.88	8.74	135.48	-0.51	2.11	2.8	142.2
5	5.563	+0.056 -0.031	0.625	0.344	5.395	-0.022	0.084	0.109	5.660
125	141.3	+1.42 -0.79	15.88	8.74	137.03	-0.56	2.13	2.8	143.8
6¼ O.D.	6.259	+0.063 -0.031	0.625	0.344	6.084	-0.022	0.088	0.109	6.350
159.0	159.0	+1.60 -0.79	15.88	8.74	154.53	-0.56	2.24	2.8	161.3
6½ O.D.	6.500	+0.063 -0.031	0.625	0.344	6.334	-0.022	0.085	0.109	6.600
165.1	165.1	+1.60 -0.79	15.88	8.74	160.88	-0.56	2.16	2.8	167.6
6	6.625	+0.063 -0.031	0.625	0.344	6.455	-0.022	0.085	0.109	6.730
150	168.3	+1.60 -0.79	15.88	8.74	163.96	-0.56	2.16	2.8	170.9
8	8.625	+0.063 -0.031	0.750	0.469	8.441	-0.025	0.092	0.109	8.800
200	219.1	+1.60 -0.79	19.05	11.91	214.40	-0.64	2.34	2.8	223.5
10	10.750	+0.063 -0.031	0.750	0.469	10.562	-0.027	0.094	0.134	10.920
250	273.1	+1.60 -0.79	19.05	11.91	268.27	-0.69	2.39	3.4	277.4
12	12.750	+0.063 -0.031	0.750	0.469	12.531	-0.030	0.109	0.156	12.920
300	323.9	+1.60 -0.79	19.05	11.91	318.29	-0.76	2.77	4.0	328.2
14 O.D.	14.000	+0.063 -0.031	0.938	0.469	13.781	-0.030	0.109	0.156	14.100
355.6	355.6	+1.60 -0.79	23.83	11.91	350.04	-0.76	2.77	4.0	358.1
16 O.D.	16.000	+0.063 -0.031	0.938	0.469	15.781	-0.030	0.109	0.165	16.100
406.4	406.4	+1.60 -0.79	23.83	11.91	400.84	-0.76	2.77	4.2	408.9
18 O.D.	18.000	+0.063 -0.031	1.000	0.469	17.781	-0.030	0.109	0.165	18.160
457.2	457.2	+1.60 -0.79	25.40	11.91	451.64	-0.76	2.77	4.2	461.3
20 O.D.	20.000	+0.063 -0.031	1.000	0.469	19.781	-0.030	0.109	0.188	20.160
508.0	508.0	+1.60 -0.79	25.40	11.91	502.44	-0.76	2.77	4.8	512.1
24 O.D.	24.000	+0.063 -0.031	1.000	0.500	23.656	-0.030	0.172	0.218	24.200
609.6	609.6	+1.60 -0.79	25.40	12.70	600.86	-0.76	4.37	5.5	614.7
30 O.D.	30.000	+0.093 -0.031	1.750 ▼	0.625	29.500	-0.063	0.250	0.250	30.200
762.0	762.0	2.36 0.79	44.45	15.88	749.30	1.60	6.35	6.35	761.1

Notes:

VdS – Roll Grooving Approval Specifications, see the Technical Data/Install Instructions section on ASC Engineered Solutions' website – www.asc-es.com

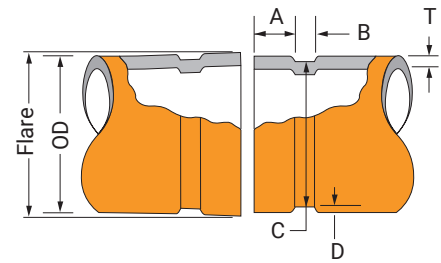

- COLUMN 1** – Nominal IPS Pipe size. Nominal ISO Pipe size.
 - COLUMN 2** – IPS outside diameter. ISO outside diameter.
 - COLUMN 3** – Gasket seat must be free from scores, seams, chips, rust or scale which may interfere with proper sealing of the gasket. Gasket seat width (Dimension A) is to be measured from the pipe end to the vertical flank in the groove wall.
 - COLUMN 4** – Groove width (Dimension B) is to be measured between vertical flank of the groove size walls.
 - COLUMN 5** – The groove must be of uniform depth around the entire pipe circumference. (See column 6)
 - COLUMN 6** – Groove depth: for reference only. Groove must conform to the groove diameter "C" listed in column 5.
 - COLUMN 7** Minimum allowable wall thickness which may be roll grooved.
 - COLUMN 8** Maximum allowable pipe end flare diameter. Measured at the most extreme pipe end diameter of the gasket seat area.
- Out of roundness:** Difference between maximum O.D. and minimum O.D. measured at 90° must not exceed total O.D. tolerance listed (reference column 2)
- For IPS pipe,** the maximum allowable tolerance from square cut ends is 0.03" for 1" thru 3½"; 0.045" for 4" thru 6"; and 0.060" for sizes 8" and above measured from a true square line.
- For ISO size pipe,** the maximum allowable tolerance from square cut ends is 0.75mm for sizes 25mm– 80mm; 1.15mm for sizes 100mm–150mm; and 1.50mm for sizes 200mm and above, measured from a true square line.
- Beveled-End Pipe** in conformance with ANSI B16.25 (37½° is acceptable, however square cut is preferred. Seams must be ground flush with the pipe O.D. and ID prior to roll grooving. Failure to do so may result in damage to the roll grooving machine and unacceptable roll grooves may be produced.
- Weld Seams** must be ground flush with the pipe O.D. and ID prior to roll grooving. Failure to do so may result in damage to the roll grooving machine and unacceptable roll grooves may be produced.
- ▼ "A" tolerance +0.030" / -0.060" (+0.77 / -1.54 mm)

Cut Groove Specification

Gruvlok Standard Cut Groove Specification or Steel & Other IPS Or ISO Size Pipe

Nominal IPS Pipe Size	O.D.		Gasket Seat "A" ±0.030/ ±0.76	Groove Width "B" ±0.030/ ±0.76	Groove Diameter "C"		Actual Groove Depth "D" (Ref. Only)	Min. Allow. Wall Thick. "T"	
	Actual	Tolerance			Actual	Tol. +0.000			
-1-	-2-	-3-	-4-	-5-	-6-	-7-			
In./DN(mm)	In./mm	+In./mm	-In./mm	In./mm	In./mm	In./mm	-In./mm	In./mm	In./mm
1	1.315	+0.015	-0.015	0.625	0.312	1.190	-0.015	0.062	0.133
25	33.4	+0.38	-0.38	15.88	7.92	30.23	-0.38	1.6	3.4
1¼	1.660	+0.016	-0.016	0.625	0.312	1.535	-0.015	0.062	0.140
32	42.2	+0.41	-0.41	15.88	7.92	38.99	-0.38	1.6	3.6
1½	1.900	+0.019	-0.019	0.625	0.312	1.775	-0.015	0.062	0.145
40	48.3	+0.48	-0.48	15.88	7.92	45.09	-0.38	1.6	3.7
2	2.375	+0.024	-0.024	0.625	0.312	2.250	-0.015	0.062	0.154
50	60.3	+0.61	-0.61	15.88	7.92	57.15	-0.38	1.6	3.9
2½	2.875	+0.029	-0.029	0.625	0.312	2.720	-0.018	0.078	0.187
65	73.0	+0.74	-0.74	15.88	7.92	69.09	-0.46	2.0	4.8
3 O.D.	2.996	+0.030	-0.030	0.625	0.312	2.845	-0.018	0.076	0.188
76.1	76.1	+0.76	-0.76	15.88	7.92	72.26	-0.46	1.9	4.8
3	3.500	+0.035	-0.031	0.625	0.312	3.344	-0.018	0.078	0.188
80	88.9	+0.89	-0.79	15.88	7.92	84.94	-0.46	2.0	4.8
3½	4.000	+0.040	-0.031	0.625	0.312	3.834	-0.020	0.083	0.188
90	101.6	+1.02	-0.79	15.88	7.92	97.38	-0.51	2.1	4.8
4¼ O.D.	4.250	+0.042	-0.031	0.625	0.375	4.084	-0.020	0.083	0.203
108.0	108.0	+1.07	-0.79	15.88	9.53	103.73	-0.51	2.1	5.2
4	4.500	+0.045	-0.031	0.625	0.375	4.334	-0.020	0.083	0.203
100	114.3	+1.14	-0.79	15.88	9.53	110.08	-0.51	2.1	5.2
5¼ O.D.	5.236	+0.052	-0.031	0.625	0.375	5.084	-0.020	0.076	0.203
133.0	133.0	+1.32	-0.79	15.88	9.53	129.13	-0.51	1.9	5.2
5½ O.D.	5.500	+0.055	-0.031	0.625	0.375	5.334	-0.020	0.083	0.203
139.7	139.7	+1.40	-0.79	15.88	9.53	135.48	-0.51	2.1	5.2
5	5.563	+0.056	-0.031	0.625	0.375	5.395	-0.022	0.084	0.203
125	141.3	+1.42	-0.79	15.88	9.53	137.03	-0.56	2.1	5.2
6¼ O.D.	6.259	+0.063	-0.031	0.625	0.375	6.084	-0.022	0.088	0.249
159.0	159.0	+1.60	-0.79	15.88	9.53	154.53	-0.56	2.2	6.3
6½ O.D.	6.500	+0.063	-0.031	0.625	0.375	6.334	-0.022	0.085	0.219
165.1	165.1	+1.60	-0.79	15.88	9.53	160.88	-0.56	2.2	5.6
6	6.625	+0.063	-0.031	0.625	0.375	6.455	-0.022	0.085	0.219
150	168.3	+1.60	-0.79	15.88	9.53	163.96	-0.56	2.2	5.6
8	8.625	+0.063	-0.031	0.750	0.437	8.441	-0.025	0.092	0.238
200	219.1	+1.60	-0.79	19.05	11.10	214.40	-0.64	2.3	6.1
10	10.750	+0.063	-0.031	0.750	0.500	10.562	-0.027	0.094	0.250
250	273.1	+1.60	-0.79	19.05	12.70	268.27	-0.69	2.4	6.4
12	12.750	+0.063	-0.031	0.750	0.500	12.531	-0.030	0.109	0.279
300	323.9	+1.60	-0.79	19.05	12.70	318.29	-0.76	2.8	7.1
14 O.D.	14.000	+0.063	-0.031	0.938	0.500	13.781	-0.030	0.109	0.281
355.6	355.6	+1.60	-0.79	23.83	12.70	350.04	-0.76	2.8	7.1
16 O.D.	16.000	+0.063	-0.031	0.938	0.500	15.781	-0.030	0.109	0.312
406.4	406.4	+1.60	-0.79	23.83	12.70	400.84	-0.76	2.8	7.9
18 O.D.	18.000	+0.063	-0.031	1.000	0.500	17.781	-0.030	0.109	0.312
457.2	457.2	+1.60	-0.79	25.40	12.70	451.64	-0.76	2.8	7.9
20 O.D.	20.000	+0.063	-0.031	1.000	0.500	19.781	-0.030	0.109	0.312
508.0	508.0	+1.60	-0.79	25.40	12.70	502.44	-0.76	2.8	7.9
24 O.D.	24.000	+0.063	-0.031	1.000	0.563	23.656	-0.030	0.172	0.375
609.6	609.6	+1.60	-0.79	25.40	14.30	600.86	-0.76	4.4	9.5
28 I.D.	28.875	+0.063	-0.031	1.000	0.563	28.531	-0.030	0.172	0.437
733.4	733.4	+1.60	-0.79	25.40	14.30	724.69	-0.76	4.4	11.1
30 I.D.	31.000	+0.063	-0.031	1.250	0.625	30.594	-0.030	0.203	0.500
787.4	787.4	+1.60	-0.79	31.75	15.88	777.09	-0.76	5.2	12.7
30 O.D.	30.000	+0.093	-0.031	1.750▼	0.625	29.500	0.063	0.250	0.500
762.0	762.0	2.36	0.79	44.45	15.88	749.30	1.60	6.35	12.7

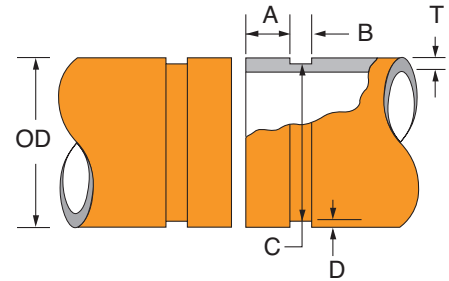

COLUMN 1 – Nominal IPS Pipe size. Nominal ISO Pipe size.

COLUMN 2 – IPS outside diameter. ISO outside diameter.

COLUMN 3 & 4 – Gasket seat must be free from scores, seams, chips, rust or scale which may interfere with proper coupling assembly.

COLUMN 5 – he groove must be of uniform depth around the entire pipe circumference. (See column 6).

COLUMN 5 – The groove must be of uniform depth around the entire pipe circumference. (See column 6).

COLUMN 6 – he groove must be of uniform depth around the entire pipe circumference. (See column 6).

COLUMN 7 – Minimum allowable wall thickness which may be cut grooved.

Out of roundness: Difference between maximum O.D. and minimum O.D. measured at 90° must not exceed total O.D. tolerance listed.

For IPS pipe, the maximum allowable tolerance from square cut ends is 0.03" for 1" thru 3½"; 0.045" for 4" thru 6"; and 0.060" for sizes 8" and above measured from a true square line.

For ISO size pipe, the maximum allowable tolerance from square cut ends is 0.75mm for sizes 25mm-80mm; 1.15mm for sizes 100mm- 150mm; and 1.50mm for sizes 200mm and above, measured from a true square line.

Beveled-End Pipe in conformance with ANSI B16.25 (37½°) is acceptable, however square cut is preferred.

Not to be used with End Guard gaskets..

▼ "A" tolerance +0.030" / -0.060"
(+0.77 / -1.54 mm)

Cut Groove End Guard® Specification

End Guard (EG) Cut Groove Specifications

Nominal IPS Pipe Size	Pipe Outside Diameter			Gasket Seat "A"		Groove Width "B"		Groove Dia. "C"		Groove Depth (Ref. Only) "D"	Min. Allow. Wall Thick. "T"
	Actual	Tolerance		Actual	Tol. +/-	Actual	Tol. (+0.010)	Actual	Tol.		
In./DN (mm)	In./mm	+In./mm	-In./mm	In./mm	In./mm	In./mm	-In./mm	In./mm	In./mm	In./mm	In./mm
2	2.375	+0.024	-0.024	0.562	+0.010	0.255	-0.005	2.250	-0.015	0.062	0.154
50	60.3	+0.61	-0.61	14.27	0.25	6.48	-0.13	57.15	-0.38	1.6	4.0
2½	2.875	+0.029	-0.029	0.562	+0.010	0.255	-0.005	2.720	-0.018	0.078	0.188
65	73.0	+0.74	-0.74	14.27	0.25	6.48	-0.13	69.09	-0.46	2.0	4.8
3	3.500	+0.035	-0.031	0.562	+0.010	0.255	-0.005	3.344	-0.018	0.078	0.188
80	88.9	+0.89	-0.79	14.27	0.25	6.48	-0.13	84.94	-0.46	2.0	4.8
4	4.500	+0.045	-0.031	0.605	+0.015	0.305	-0.005	4.334	-0.020	0.083	0.203
100	114.3	+1.14	-0.79	15.37	0.38	7.75	-0.13	110.08	-0.51	2.1	5.2
5	5.563	+0.056	-0.031	0.605	+0.015	0.305	-0.005	5.395	-0.022	0.084	0.203
125	141.3	+1.42	-0.79	15.37	0.38	7.75	-0.13	137.03	-0.56	2.1	5.2
6	6.625	+0.063	-0.031	0.605	+0.015	0.305	-0.005	6.455	-0.022	0.085	0.219
150	168.3	+1.60	-0.79	15.37	0.38	7.75	-0.13	163.96	-0.56	2.2	5.6
8	8.625	+0.063	-0.031	0.714	+0.015	0.400	-0.010	8.441	-0.025	0.092	0.238
200	219.1	+1.60	-0.79	18.14	0.38	10.16	-0.254	214.40	-0.64	2.3	6.1
10	10.750	+0.063	-0.031	0.714	+0.015	0.400	-0.010	10.562	-0.027	0.094	0.250
250	273.1	+1.60	-0.79	18.14	0.38	10.16	-0.25	268.27	-0.69	2.4	6.4
12	12.750	+0.063	-0.031	0.714	+0.015	0.400	-0.010	12.531	-0.030	0.109	0.279
300	323.9	+1.60	-0.79	18.14	0.38	10.16	-0.25	318.29	-0.76	2.8	7.1

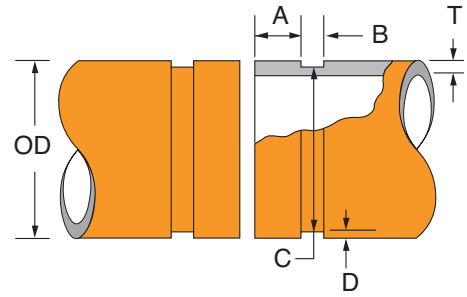

End Guard (EG) cut groove is designed for standard or heavier wall thickness pipe to be joined by Fig. 7004 with EG® gasket couplings. Gruvlok EG fittings are grooved in accordance with these dimensions.

*Refer to additional notes on previous page.

Roll Groove End Guard® Specification

End Guard (EG) Roll Groove Specifications

Nominal IPS Pipe Size	Pipe Outside Diameter			Gasket Seat "A"		Groove Width "B"		Groove Dia. "C"		Groove Depth (Ref. Only) "D"	Min. Allow. Wall Thick. "T"
	Actual	Tolerance		Actual	Tol. +/-	Actual	Tol. (+0.010)	Actual	Tol.		
In./DN (mm)	In./mm	+In./mm	-In./mm	In./mm	In./mm	In./mm	-In./mm	In./mm	In./mm	In./mm	In./mm
2	2.375	+0.024	-0.024	0.572	-0.020	0.250	+0.015	2.250	-0.015	0.062	0.065
50	60.3	+0.61	-0.61	+14.53	-0.51	6.35	0.38	57.15	-0.38	1.6	1.7
2½	2.875	+0.029	-0.029	0.572	-0.020	0.250	+0.015	2.720	-0.018	0.078	0.083
65	73.0	+0.74	-0.74	+14.53	-0.51	6.35	0.38	69.09	-0.46	2.0	2.1
3	3.500	+0.035	-0.031	0.572	-0.020	0.250	+0.015	3.344	-0.018	0.078	0.083
80	88.9	+0.89	-0.79	+14.53	-0.51	6.35	0.38	84.94	-0.46	2.0	2.1
4	4.500	+0.045	-0.031	0.610	-0.020	0.300	+0.020	4.334	-0.020	0.083	0.083
100	114.3	+1.14	-0.79	+15.49	-0.51	7.62	0.51	110.08	-0.51	2.1	2.1
5	5.563	+0.056	-0.031	0.610	-0.020	0.300	+0.020	5.395	-0.022	0.084	0.109
125	141.3	+1.42	-0.79	+15.49	-0.51	7.62	0.51	137.03	-0.56	2.1	2.8
6	6.625	+0.063	-0.031	0.610	-0.020	0.300	+0.020	6.455	-0.022	0.085	0.109
150	168.3	+1.60	-0.79	+15.49	-0.51	7.62	0.51	163.96	-0.56	2.2	2.8
8	8.625	+0.063	-0.031	0.719	-0.020	0.390	+0.020	8.441	-0.025	0.092	0.109
200	219.1	+1.60	-0.79	+18.26	-0.51	9.91	0.51	214.40	-0.64	2.3	2.8
10	10.750	+0.063	-0.031	0.719	-0.020	0.390	+0.020	10.562	-0.027	0.094	0.134
250	273.1	+1.60	-0.79	+18.26	-0.51	9.91	0.51	268.27	-0.69	2.4	3.4
12	12.750	+0.063	-0.031	0.719	-0.020	0.390	+0.020	12.531	-0.030	0.109	0.156
300	323.9	+1.60	-0.79	+18.26	-0.51	9.91	0.51	318.29	-0.76	2.8	4.0

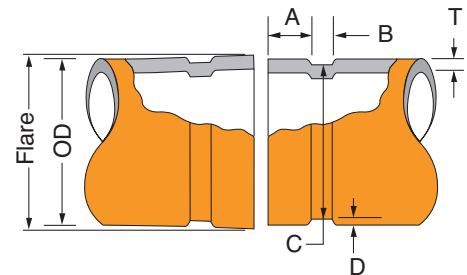

End Guard (EG) roll groove is designed for standard or heavier wall thickness pipe to be joined by Fig. 7004 with EG® gasket couplings.

*Refer to additional notes on previous page.

Double Cut Groove Specification

Gruvlok Standard Double Cut Groove Specification or Steel & Other IPS Or ISO Size Pipe

-1- Nominal IPS Pipe Size	-2- O.D.		-3- Gasket Seat "A" ±0.030/ ±0.76		-4- Groove Sep "G" ±0.005/ ±0.127		-5- Groove Width "B" ±0.030/ ±0.76		-6- Groove Diameter "C"		-7- Actual Groove Depth "D" (Ref. Only)	-8- Min. Allowable Bolt Torque Required for Assembly
	Actual	Tolerance	In./mm	In./mm	In./mm	In./mm	In./mm	In./mm	In./mm	Tol. +0.000		
In./DN(mm)	In./mm	+In./mm	-In./mm	In./mm	In./mm	In./mm	In./mm	In./mm	-In./mm	In./mm	Ft.-Lbs./N-m	
6 150	6.625 168.3	+0.063 +1.60	-0.031 -0.79	0.625 15.88	0.785 20.0	0.375 9.53	6.340 161.0	-0.022 -0.56	0.142 3.6	450 610.2		
8 200	8.625 219.1	+0.063 +1.60	-0.031 -0.79	0.750 19.05	0.855 21.7	0.500 12.70	8.240 209.3	-0.022 -0.56	0.192 4.9	500 678.0		
10 250	10.750 273.1	+0.063 +1.60	-0.031 -0.79	0.750 19.05	0.855 21.7	0.500 12.70	10.350 262.9	-0.022 -0.56	0.200 5.1	500 678.0		

Gruvlok "End Guard" Double Cut Groove Specification or Steel & Other Ips Or Iso Size Pipe

-1- Nominal IPS Pipe Size	-2- O.D.		-3- Gasket Seat "A" ±0.030/ ±0.76		-4- Groove Sep "G" ±0.005/ ±0.127		-5- Groove Width "B" ±0.030/ ±0.76		-6- Groove Diameter "C"		-7- Actual Groove Depth "D" (Ref. Only)	-8- Min. Allowable Bolt Torque Required for Assembly
	Actual	Tolerance	In./mm	In./mm	In./mm	In./mm	In./mm	In./mm	In./mm	Tol. +0.000		
In./DN(mm)	In./mm	+In./mm	-In./mm	In./mm	In./mm	In./mm	In./mm	In./mm	-In./mm	In./mm	Ft.-Lbs./N-m	
6 150	6.625 168.3	+0.063 +1.60	-0.031 -0.79	0.605 15.4	0.785 20.0	0.375 9.53	6.340 161.0	-0.022 -0.56	0.142 3.6	450 610.2		
8 200	8.625 219.1	+0.063 +1.60	-0.031 -0.79	0.714 18.1	0.855 21.7	0.500 12.70	8.240 209.3	-0.022 -0.56	0.192 4.9	500 678.0		
10 250	10.750 273.1	+0.063 +1.60	-0.031 -0.79	0.714 18.1	0.855 21.7	0.500 12.70	10.350 262.9	-0.022 -0.56	0.200 5.1	500 678.0		

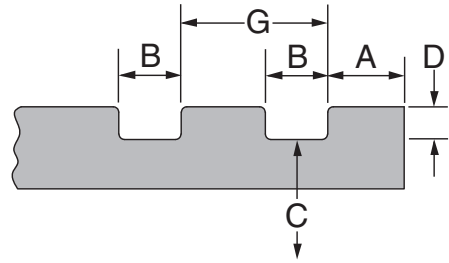

COLUMN 1 – Nominal IPS Pipe size.
Nominal ISO Pipe size.

COLUMN 2 – IPS outside diameter. ISO outside diameter.

COLUMN 3, 4 & 5 – Gasket seat must be free from scores, seams, chips, rust or scale which may interfere with proper coupling assembly.

COLUMN 6 – The groove must be of uniform depth around the entire pipe circumference. (See column 7).

COLUMN 7 – Groove depth: for reference only. Groove must conform to the groove diameter "C" listed in column 6.

COLUMN 8 – Minimum allowable bolt torque required for complete assembly.

Out of roundness: Difference between maximum O.D. and minimum O.D. measured at 90° must not exceed total O.D. tolerance listed.

For IPS pipe, the maximum allowable tolerance from square cut ends is 0.03" for 1" thru 3½"; 0.045" for 4" thru 6"; and 0.060" for sizes 8" and above measured from a true square line.

For ISO size pipe, the maximum allowable tolerance from square cut ends is 0.75mm for sizes 25mm–80mm; 1.15mm for sizes 100mm–150mm; and 1.50mm for sizes 200mm and above, measured from a true square line.

Beveled-End Pipe in conformance with ANSI B16.25 (37½°) is acceptable, however square cut is preferred.

Gruvlok CTS Copper System Specification Roll Groove Specification

Gruvlok CTS Copper System – Roll Groove Specification

Nominal Size	Tubing Outside Diameter		Gasket Seat "A" +/- 0.03 in. +/- 0.76 mm	Groove Width "B" +0.03/-0.00 in. +0.76/-0.00mm	Groove Diameter "C"		Nominal Groove Depth "D"	Min. Wall "T"	Max. Flare Diam.	
	Actual	Tolerance			Actual	Tolerance				
	In.	In./mm			In./mm	In./mm				
2	2.125 54.0	0.002 0.05	0.002 0.05	0.610 15.5	0.300 7.6	2.029 51.54	-0.020 -0.51	0.048 1.2	0.058 1.6	2.220 56.4
2½	2.625 66.7	0.002 0.05	0.002 0.05	0.610 15.5	0.300 7.6	2.525 64.14	-0.020 -0.51	0.050 1.3	0.065 1.7	2.720 69.1
3	3.125 79.4	0.002 0.05	0.002 0.05	0.610 15.5	0.300 7.6	3.025 76.84	-0.020 -0.51	0.050 1.3	DWV	3.220 81.8
4	4.125 104.8	0.002 0.05	0.002 0.05	0.610 15.5	0.300 7.6	4.019 102.08	-0.020 -0.51	0.053 1.3	DWV	4.220 107.2
5	5.125 130.2	0.002 0.05	0.002 0.05	0.610 15.5	0.300 7.6	4.999 126.97	-0.020 -0.51	0.053 1.3	DWV	5.220 132.6
6	6.125 155.6	0.002 0.05	0.002 0.05	0.610 15.5	0.300 7.6	5.999 152.37	-0.020 -0.51	0.063 1.6	DWV	6.220 158.0
8	8.125 206.4	0.002 0.05	0.004 0.10	0.610 15.5	0.300 7.6	7.959 202.16	-0.020 -0.51	0.083 2.1	DWV	8.220 208.8

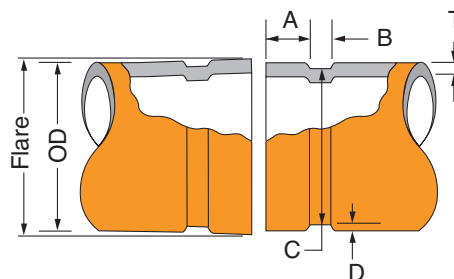

COLUMN 1 – Nominal tubing size ASTM B88

COLUMN 2 – Outside diameter of copper tubing per ASTM B88. Allowable tolerance from square cut ends is 0.030"/0.76mm for sizes 2"-3"; 0.045"/1.14mm for sizes 4-8".

COLUMN 3– Gasket seat must be free from scores, roll marks, indentations, grease and dirt which may interfere with gasket sealing.

COLUMN 4 – Groove width is to be free from chips, dirt, etc. which may interfere with proper coupling assembly.

COLUMN 5 – Groove diameter must be of uniform depth for the entire circumference of the tubing. See column 6.

COLUMN 6 – Groove depth is for reference only; the groove diameter must conform to column 5.

COLUMN 7 – DWV (Drain, Waste and Vent Piping) per ASTM B306.

COLUMN 8 – Maximum flare diameter is the OD at the most extreme tubing diameter.

CPVC Cut Groove Specification

CPVC Cut Groove is designed for use on Schedule 80
CPVC Corzan Pipe (ASTM F441)

CPVC Cut Groove Specification

Nominal Pipe Size	Pipe Outside Diameter				Gasket Seat "A" ±0.03/ ± 0.76	Groove Width "B" ±0.030/ ±0.76	Groove Diameter "C"		Actual Groove Depth "D" (Ref Only)	Min. Allow Wall Thick. "T"	Groove Radius "R"
	Actual	Tolerance		Actual			Tolerance				
	In./DN	In./mm	+ In./mm	- In./mm	In./mm	In./mm	In./mm	- In./mm	In./mm	In./mm	In./mm
2 50	2.375 60.3	+0.006 +0.15	-0.006 -0.15	0.625 15.8	0.312 7.92	2.250 57.15	-0.015 -0.38	0.062 1.6	0.218 5.54	0.045 1.14	
2½ 65	2.875 72.0	+0.007 +0.18	-0.007 -0.18	0.625 15.8	0.312 7.92	2.720 69.09	-0.018 -0.46	0.078 2.0	0.276 7.01	0.045 1.14	
3 80	3.500 88.9	+0.008 +0.20	-0.008 -0.20	0.625 15.8	0.312 7.92	3.344 84.94	-0.018 -0.46	0.078 2.0	0.300 7.62	0.045 1.14	
4 100	4.500 114.3	+0.009 +0.23	-0.009 -0.23	0.625 15.8	0.375 9.53	4.334 110.08	-0.020 -0.51	0.083 2.2	0.337 8.56	0.045 1.14	
6 150	6.625 168.3	+0.011 +0.28	-0.011 -0.28	0.625 15.8	0.375 9.53	6.455 163.96	-0.022 -0.56	0.085 2.2	0.432 10.97	0.045 1.14	
8 200	8.625 219.1	+0.015 +0.38	-0.015 -0.38	0.750 19.05	0.437 11.10	8.441 214.40	-0.025 -0.64	0.092 2.3	0.500 12.70	0.078 1.98	

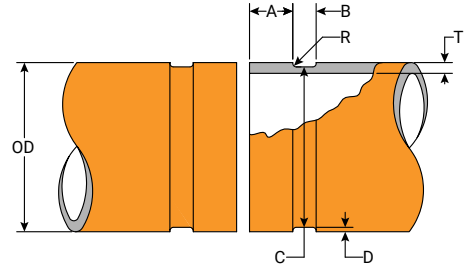

Notes:

1. ASC Recommended Groover: Rex Wheeler 6950 Plastic Cut Groover.
2. CPVC pipe manufactured per ASTM F441. Minimum cell class "23447" per ASTM D1784.

Master Format 3 Part Specifications

ASC Engineered Solutions provides our customers with master specification formats for a wide range of piping construction needs. ASC's customers can utilize our specifications to help update and revise their current internal building specifications. These master specifications include a three part format, Part 1: General, Part 2: Product, & Part 3: Execution that included the complete catalog of products.

ASC provides a master specifications format for all building and construction needs including:

- Basic Mechanical Methods and Materials
- Hanger & Supports
- Pipes, Valves, & Fittings for Fire Protection
- Pipes, Valves, & Fittings for Plumbing Systems
- Pipes, Valves, & Fittings for HVAC Heating and Cooling Systems

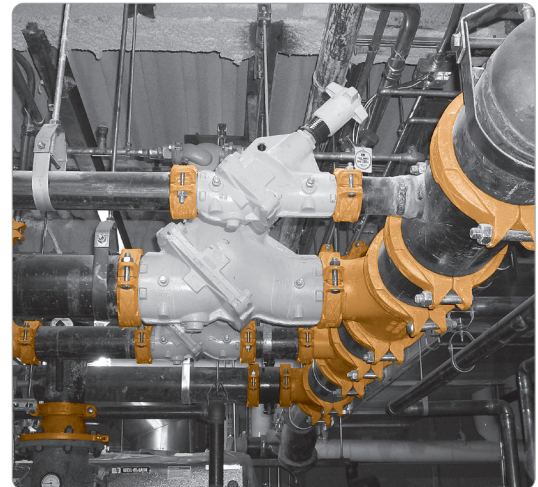

All Master Format Specification are available for download in WORD and PDF format.
Please follow the web address below for download links:

<https://www.asc-es.com/resources-and-downloads/masterformat-specifications>

Malleable Iron Fittings – Pipe Fittings

Malleable Iron Threaded Fittings – Class 150 (Standard)

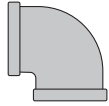

Fig. 1101
90° Elbow
Size Range:
1/8" – 6" NPS



Fig. 1102
45° Elbow
Size Range:
1/8" – 6" NPS



Fig. 1104
45° Street Elbow
Size Range:
1/8" – 2" NPS

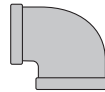

Fig. 1101R
Reducing Elbow
Size Range: 1/4" x 1/8"
thru 4" x 3" NPS



Fig. 1103- Straight
Fig. 1103R- Reducing
90° Street Elbow
Size Range:
Fig. 1103: 1/8" – 4"
Fig. 1103R: 1/2" x 3/8"
thru 2" x 1/2"

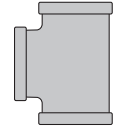

Fig. 1105 Straight
Fig. 1105R Reducing
Size Range:
Fig. 1105: 1/8" – 6" NPS
Fig. 1105R: 1/8" x 1/8" x 1/4"
thru 4" x 4" x 3" NP

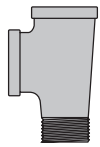

Fig. 1106 Straight
Fig. 1106R Reducing
Street or Service Tee
Size Range:
Fig. 1106: 1/8" – 2" NPS
Fig. 1106R: 1/4" x 1" x 1/4"

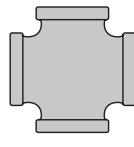

Fig. 1107
Cross
Size Range:
1/8" – 4" NPS

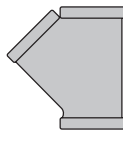

Fig. 1108
45° Y-Branch
or Lateral
Size Range: 3/8" – 4" NPS



Fig. 1121
Coupling
Size Range: 1/8" – 4" NPS

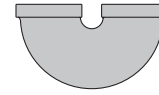

Fig. 1119
Return Bends
Open Pattern
– Right Hand
Size Range: 1/2" – 2" NPS

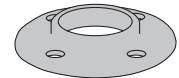

Fig. 1190
Floor Flange
(Ductile Iron)
Size Range: 1/4" – 2" NPS



Fig. 1125
Reducer
Size Range:
1/4" x 1/8"
thru 6" x 4" NPS



Fig. 1124
Cap
Size Range: 1/2" – 6" NPS



Fig. 1134
Hex Locknut
Size Range: 1/4" – 2" NPS

Malleable Iron Plain Fittings

NOTE: Not to be used for pressure service.



Fig. 1133
Waste Nut
Sizes: 1/2" & 3/4" NPS



Fig. 1138
Extension Piece
Size Range: 1/2" – 1" NPS

Malleable Iron Threaded Fittings – Class 300 (XS/XH)

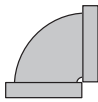

Fig. 1161- Straight
Fig. 1161R- Reducing
90° Elbow
Size Range:
Fig. 1161: 1/4" – 4" NPS
Fig. 1161R: 3/8" x 1/4"
thru 2" x 1/2" NPS

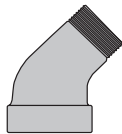

Fig. 1160
45° Street Elbow
Size Range: 1/2" – 2" NPS

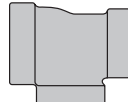

Fig. 1164R
Reducing Tee
Size Range: 3/8" x 3/8" x 1/4"
thru 3" x 3" x 2" NPS

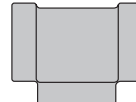

Fig. 1164
Straight Tee
Size Range:
1/4" – 4" NPS

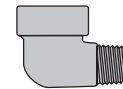

Fig. 1170
90° Street Elbow
Size Range:
1/4" – 3" NPS

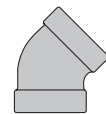

Fig. 1162
45° Elbow
Size Range:
1/4" – 4" NPS

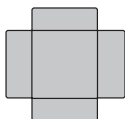

Fig. 1165
Cross
Size Range: 1/4" – 2" NPS



Fig. 1167
Reducer
Size Range: 3/8" x 1/4"
thru 4" x 3" NPS



Fig. 1166
Coupling
Size Range: 1/4" – 3" NPS



Fig. 1163
Cap
Size Range: 1/4" – 3" NPS



Fig. 390
Countersunk Plugs
Size Range: 1/2" – 3/4" NPS

Malleable Iron Unions – Class 150; 250; 300 – Pipe Fittings (Continued)

Copper or Copper Alloy to Iron

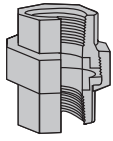

Fig. 463
Class 150 Union
150 Lb. WSP; 300 Lb. WOG, Non-Shock
Size Range: 1/8" – 3" NPS

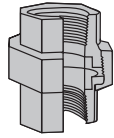

Fig. 554
Class 250 Union
250 Lb. WSP; 500 Lb. WOG, Non-Shock
Size Range: 1/8" – 4" NPS

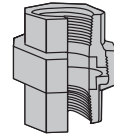

Fig. 459
Class 300 Union
300 Lb. WSP; 600 Lb. WOG, Non-Shock
Size Range: 1/8" – 4" NPS

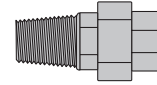

Fig. 551
Class 300 Union
(Male/Female)
300 Lb. WSP; 600 Lb. WOG, Non-Shock
Size Range: 1/2" – 2" NPS

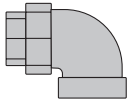

Fig. 552
Class 300 90° Elbow
Female Union
300 Lb. WSP
Size Range: 3/4" – 1" NPS

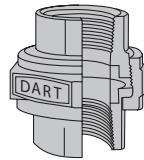

Fig. 832
Dart Union Bronze to
Bronze Seat Union
Size Range: 3/8" – 2" NPS

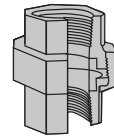

Fig. J-3300
Class 300 All Iron Union
Size Range: 1/4" – 3" NPS

Cast Iron Fittings

Cast Iron Threaded Fittings – Class 125 (Standard)

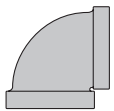

Fig. 351
90° Elbow
Size Range: 1/4" – 8" NPS

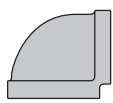

Fig. 352
90° Reducing Elbow
Size Range:
1/2" x 1/4" thru 6" x 5"

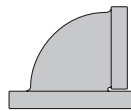

Fig. 371
90° Elbow
Flange & Screw
Size Range: 2 1/2" – 6" NPS

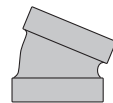

Fig. 356A
22 1/2° Elbow
Size Range:
3/4" – 2 1/2" NPS

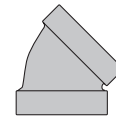

Fig. 356
45° Elbow
Size Range:
1/4" – 8" NPS

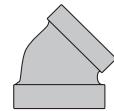

Fig. 356R
45° Reducing Elbow
Size Range:
1" x 1/2" NPS

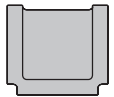

Fig. 358
Straight Tee
Size Range:
1/4" – 8" NPS

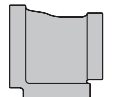

Fig. 359
Reducing Tee
Size Range:
1/2" x 1/2" x 1/2"
thru 6" x 6" x 5" NPS



Fig. 360
Straight Cross
Size Range:
1/2" – 6" NPS



Fig. 361
Reducing Cross
Size Range:
1" x 1" x 3/4" x 3/4"
thru 4" x 4" x 2" x 2" NPS



Fig. 366
Screwed Hex
Coupling
Size: 1" NPS



Fig. 367
Concentric
Reducer
Size Range: 3/4" x 1/2"
thru 8" x 6" NPS



Fig. 368
Eccentric Reducer
Size Range: 3/4" x 1/2"
thru 6" x 4" NPS



Fig. 383
Hex Bushing
Size Range: 1 1/2" x 1/4"
thru 10" x 8" NPS



Fig. 385
Face Bushing
Size Range: 3" x 2"
thru 4" x 3" NPS



Fig. 387
Square Head
Plug (Cored)
Size Range: 3/4" – 4" NPS



**Fig. 380–Solid
Fig. 389–Cored
Bar Plugs**
Size Range:
4" – 8" NPS



Fig. 487
Flange Union Gasket
Type
Size Range:
1/2" – 8" NPS
(Assembled with Gaskets)



Fig. 388
Square Head
Plug (Solid)
Size Range:
1/2" – 3 1/2" NPS



Fig. 390
Countersunk Plugs
Size Range:
1" – 4" NPS



Fig. 381
Cap
Size Range:
2 1/2" – 8" NPS



Fig. 370
Locknut
Size Range:
2 1/2" – 4" NPS

Cast Iron Fittings – Pipe Fittings (Continued)

Cast Iron Flanged Fittings – Class 125 (Standard)

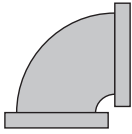

Fig. 801
90° Straight Elbow
Size Range: 1½" – 12" NPS

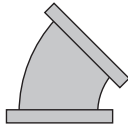

Fig. 802
45° Straight Elbow
Size Range: 1½" – 12" NPS

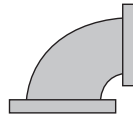

Fig. 803
90° Taper
Reducing Elbow
Size Range:
2½" x 2" thru 12" x 10" NPS

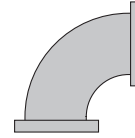

Fig. 804– Straight
Fig. 804R– Reducing
Long Radius Elbow
Size Range:
Fig. 804: 2" – 12" NPS
Fig. 804R: 4" x 3" thru 10" x 8"

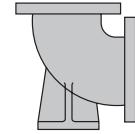

Fig. 805
Base Elbow
Size Range: 3" – 12" NPS

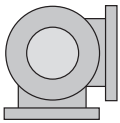

Fig. 810
Side Outlet Elbow
Size Range: 4" – 8" NPS

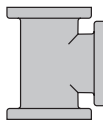

Fig. 811
Straight Tee
Size Range: 1½" – 12" NPS

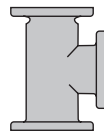

Fig. 812
Reducing Tee
Size Range: 3" x 2" x 3"
thru 12" x 12" x 10"

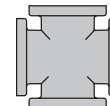

Fig. 821
Cross
Size Range: 2" – 10" NPS

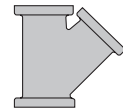

Fig. 823
Lateral
Size Range: 2" – 8" NPS



Fig. 825
Concentric Reducer
Size Range: 2" x 1½"
thru 12" x 10" NPS



Fig. 826
Eccentric Reducer
Size Range: 3" x 2"
thru 12" x 10" NPS

Iron Flanges – Class 125 (Standard)



Fig. 1011
Cast Iron
Companion Flange
Size Range: Fig. 1011
¾" x 3⅞" thru 12" x 19" NPS



Fig. 1016
Reducing
Companion Flange
Size Range:
1" x 5" thru 8" x 19" NPS

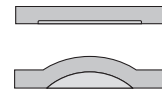

Fig. 1018
Cast Iron Blind Flange
Size Range:
1" x 4¼" thru 12" x 19" NPS

Iron Flanges – Class 250 (Extra Heavy)



Fig. 1021
Cast Iron
Blind Flange
Size Range:
1½" x 6⅞" thru 8" x 15" NPS



Fig. 1025
Cast Iron
Companion Flange
Size Range:
1¼" x 5¼" thru 8" x 15" NPS



Fig. 1030
Cast Iron
Companion Flange
Size Range:
2" x 8¼" thru 4" x 11" NPS

Pipe Nipples – Pipe Fittings (Continued) Seamless/Welded – Black & Galvanized



Seamless Pipe Nipples

Std. Sch. 40,
XH Sch. 80,
Sch. 160, XXH
Size Range: 1/8" thru 6"

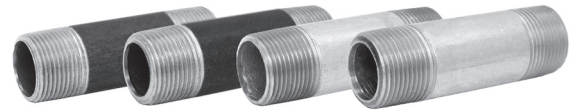

Welded Pipe Nipples

Std. Sch. 40, XH Sch. 80
Size Range: 1/8" thru 6"

Steel Fittings

Steel Pipe Couplings



Fig. 336

Standard, Full & Half
Size Range: 1/8" – 6" NPS



Fig. 337

Extra Strong (XS), Full & Half
Size Range: 1/8" – 6" NPS



Fig. 346

Standard, Right & Left
Size Range: 1/2" – 2" NPS



Fig. 347

Extra Strong (XS),
Right & Left
Size Range: 1/3" – 2" NPS



Fig. 348

API Line Pipe Coupling
Size Range: 1/8" – 12" NPS



Fig. 379

Shallow Well Coupling
Size Range: 1/4" – 2" NPS



Fig. 349

Water Well Reamed and
Drifted Coupling
Size Range: 1/4" – 12" NPS



Fig. 350

#9 Drive Coupling
Size Range: 1/4" – 2" NPS

Merchant Steel Bushings, Caps & Plugs



Hex Bushing

Size Range: 1/4" x 1/8"
thru 1" x 3/4" NPS



Countersunk Plug

(Square & Hex Socket)
Size Range: 1/8" – 2" NPS



Flush Bushing

Size Range: 1/4" x 1/8"
thru 1/2" x 3/8" NPS

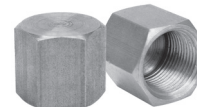

Cap

Size Range: 1/8" – 3/4" NPS



Solid Square Head Plug

Size Range: 1/8" – 2" NPS

Cast Iron Fittings – Pipe Fittings (Continued)

Cast Iron Threaded Fittings – Class 250 (Extra Heavy)

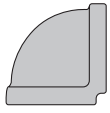

Fig. 421 90° Elbow
Size Range: 1/4" – 3" NPS

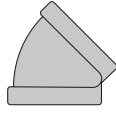

Fig. 424 45° Elbow
Size Range: 1/2" – 2 1/2" NPS

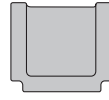

Fig. 425 Tee
Size Range: 1/2" – 4" NPS

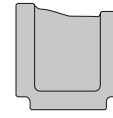

Fig. 426 Reducing Tee
Size Range: 3/4" x 3/4" x 1/2"
thru 2" x 2" x 1 1/2"

Cast Iron Threaded Safety Valve Discharge Elbow

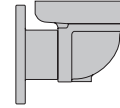

Fig. 1538
Screwed Cast Iron
Size Range: 2 1/2" – 4" NPS

Cast Iron Drainage Fittings

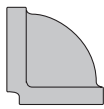

Fig. 701
90° Short Turn Elbow
Size Range: 1 1/2" – 4" NPS

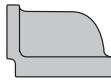

Fig. 701R 90° Reducing
Short Turn Elbow
Sizes: 1 1/2" x 1 1/4" & 2" x 1 1/2"
NPS

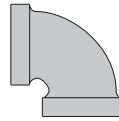

Fig. 702
90° Long Turn Elbow
Size Range: 1 1/2" – 4" NPS

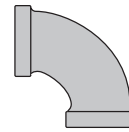

Fig. 702A
90° Extra Long
Turn Elbow
Sizes: 1 1/2" & 2" NPS

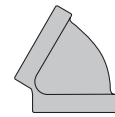

Fig. 703
60° Short Turn Elbow
Size: 1 1/2" NPS



Fig. 705
45° Short Turn Elbow
Size Range: 1 1/2" – 4" NPS



Fig. 706
45° Long Turn Elbow
Size: 1 1/2" NPS



Fig. 707
22 1/2° Elbow
Sizes: 1 1/2" & 2" NPS



Fig. 708 1 1/4° Elbow
Sizes: 1 1/2" & 2" NPS

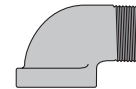

Fig. 718 90° Street Elbow
Sizes: 1 1/2" & 2" NPS

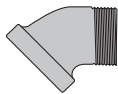

Fig. 719 45° Street Elbow
Sizes: 1 1/2" & 2" NPS

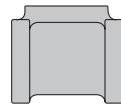

Fig. 722 Tee
Sizes: 1 1/2" & 2" NPS



Fig. 723 Reducing Tee
Size: 2" x 2" x 1 1/2" NPS

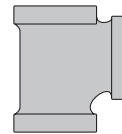

Fig. 726 Sanitary Tee
90° Short Turn
Size Range: 1 1/2" – 4" NPS

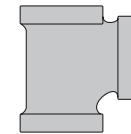

Fig. 727 Sanitary Tee
90° Reducing Short Turn
Sizes: 2" x 2" x 1 1/2" &
2" x 1 1/2" x 1 1/2"

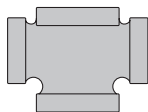

Fig. 729 Sanitary Tee
90° Reducing Double Short
Turn
Size: 2" x 1 1/2" NPS

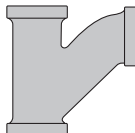

Fig. 730
Y-Branch
90° Long Turn
Sizes: 1 1/2" & 2" NPS

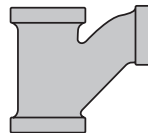

Fig. 731
Y-Branch 90° Reducing
Long Turn
Size: 2" x 2" x 1 1/2" NPS

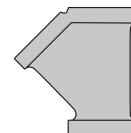

Fig. 734
45° Y-Branch
Sizes: 1 1/2" – 4" NPS

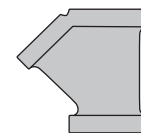

Fig. 735
45° Reducing Y-Branch
Sizes: 2" x 2" x 1 1/2"
& 4" x 4" x 3"

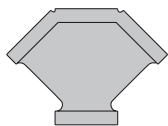

Fig. 736
45° Double Y-Branch
Size: 1 1/2" NPS

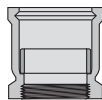

Fig. 744
Tucker Connection
Size Range: 1 1/2" – 4" NPS



Fig. 753
Coupling
Size: 1 1/2" NPS

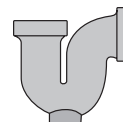

Fig. 752
P-Trap
Size Range: 1 1/2" – 3" NPS

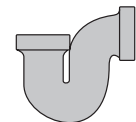

Fig. 754
Bath P-Trap
Sizes: 1 1/2" & 2" NPS

Forged Steel Fittings – Pipe Fittings (Continued)

Class 2000 Threaded

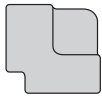

Fig. 2101 90° Elbow
Size Range: 1/4" - 4" NPS



Fig. 2102 45° Elbow
Size Range: 1/4" - 4" NPS

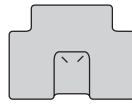

Fig. 2103 Tee
Size Range: 1/4" - 4" NPS

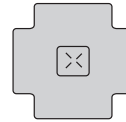

Fig. 2104 Cross
Size Range: 1/4" - 4" NPS

Class 3000 Threaded

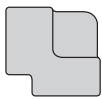

Fig. 2111 90° Elbow
Size Range: 1/8" - 4" NPS



Fig. 2112 45° Elbow
Size Range: 1/8" - 4" NPS

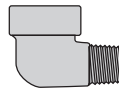

Fig. 2113 90° Street Elbow
Size Range: 1/8" - 2" NPS

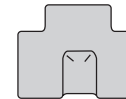

Fig. 2114 Tee
Size Range: 1/8" - 4" NPS

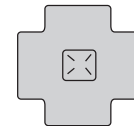

Fig. 2115 Cross
Size Range: 1/8" - 4" NPS

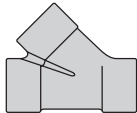

Fig. 2116 Lateral
Size Range: 1/2" - 2" NPS

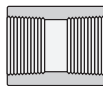

Fig. 2117 Coupling
Size Range: 1/8" - 4" NPS

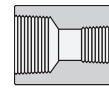

Fig. 2118
Reducing Coupling
Size Range:
1/4" x 1/8" - 4" x 1 1/2" NPS



Fig. 2119
Half Coupling
Size Range: 1/8" - 4" NPS



Fig. 2120 Pipe Cap
Size Range: 1/8" - 4" NPS

Class 6000 Threaded

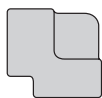

Fig. 2131 90° Elbow
Size Range: 1/8" - 4" NPS



Fig. 2132 45° Elbow
Size Range: 1/2" - 3" NPS

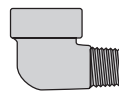

Fig. 2133 90° Street Elbow
Size Range: 1/2" - 1 1/2" NPS



Fig. 2134 Tee
Size Range: 1/4" - 3" NPS
(4" POA)

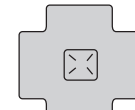

Fig. 2135 Cross
Size Range: 1/2" - 3" NPS
(1/4" POA)

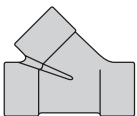

Fig. 2136 Lateral
Size Range: 1/2" - 1 1/2" NPS

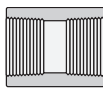

Fig. 2137 Coupling
Size Range: 1/8" - 4" NPS

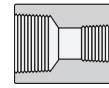

Fig. 2138
Reducing Coupling
Size Range: 1/4" x 1/8"
- 4" x 2" NPS



Fig. 2141 Half Coupling
Size Range: 1/4" - 2" NPS
(1/8" POA)



Fig. 2143 Pipe Cap
Size Range: 1/2" - 3" NPS
(1/8" - 3/8", 4" POA)

Class 3000 Socket Weld

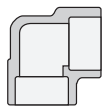

Fig. 2150 90° Elbow
Size Range: 1/8" - 4" NPS

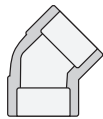

Fig. 2151 45° Elbow
Size Range: 1/8" - 4" NPS

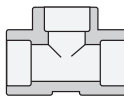

Fig. 2152 Tee
Size Range: 1/8" - 4" NPS

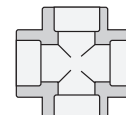

Fig. 2153 Cross
Size Range: 1/2" - 3" NPS
(1/8" - 3/8" POA)

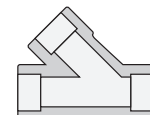

Fig. 2158 Lateral
Size Range: 1/2" - 2" NPS



Fig. 2154 Couplings
Size Range: 1/8" - 4" NPS



Fig. 2156
Reducing Coupling
Size Range:
1/4" x 1/8" - 4" x 2" NPS



Fig. 2155 Half Coupling
Size Range: 1/2" - 4" NPS
(1/8" - 3/8" POA)



Fig. 2157 Pipe Cap
Size Range: 1/8" - 4" NPS

Forged Steel Fittings – Pipe Fittings (Continued)

Class 6000 Socket-Weld

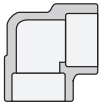

Fig. 2170 90° Elbow
Size Range: ½" – 4" NPS

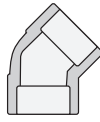

Fig. 2171 45° Elbow
Size Range: ½" – 4" NPS

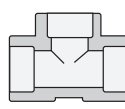

Fig. 2172 Tee
Size Range: ½" – 4" NPS

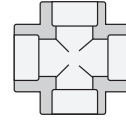

Fig. 2173 Cross
Size Range: ½" – 2" NPS

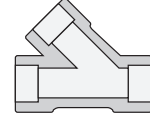

Fig. 2178 Lateral
Size Range: ½" – 2" NPS



Fig. 2174 Couplings
Size Range: ½" – 2" NPS
(2½" – 4" POA)



Fig. 2176
Reducing Coupling
Size Range: ¾" x ¼" – 4" x 2" NPS



Fig. 2175
Half Couplings
Size Range: ½" – 2" NPS
(2½" – 4" POA)



Fig. 2177
Pipe Caps
Size Range: ½" – 2" NPS
(2½" – 4" POA)

High Pressure Plugs & Bushings

Anvil High Pressure Plugs and Bushings satisfy the requirement of ASME B16.11 Class 2000, 3000, and 6000.

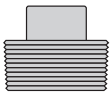

Fig. 2122
Plugs Square Head
Size Range: ½" – 4" NPS

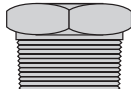

Fig. 2142
Plugs Hex Head
Size Range: ½" – 4" NPS

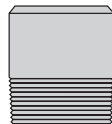

Fig. 2121
Plugs Round Head
Size Range: ½" – 2" NPS



Fig. 2139
Bushings Hex Head
Size Range: ¼" x ⅛"
– 4" x 1½" NPS



Fig. 2140
Bushings Flush
Size Range:
¼" x ⅛" – 2" x ¼"
(All sizes are POA)

Socket-Weld Reducer Inserts

Reducer inserts comply with MSS Standard SP-79. They enable standard socket-weld fittings to be used for making any combination of pipe line reductions quickly and economically. Socket-weld reducer inserts serve the same purpose as threaded reducing bushings with threaded fittings

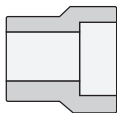

Fig. 2159
(Type 1)

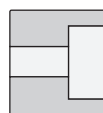

Fig. 2179
(Type 2)

Class 3000

For use with Schedule 40 & 80 Pipe

Type 1 – Reducer Insert: Size Range: ½" x ⅜" thru 3" x 2½" NPS

Type 2 – Reducer Insert: Size Range: ½" x ⅜" thru 3" x 2½" NPS

Class 6000

For use with Schedule 160 Pipe

Type 1 – Reducer Insert: Size Range: ¾" x ½" thru 2" x 1½" NPS

Type 2 – Reducer Insert: Size Range: ¾" x ½" thru 2" x 1½" NPS

Miscellaneous



When ordering, specify bolt size & length required.

Bolts are furnished in sizes:

¼", ⅝", ⅜", ⅞", 1", 1⅛", 1¼" (6.3, 7.9, 9.5, 11, 25, 29 and 32 mm)
in varying lengths.

Length of bolts are measured from under head to extreme point.

Floor & Ceiling Plates

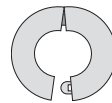

Fig. 1
with Springs

Fig. 2
with Set Screw
Stamped Steel for Copper Tube
Size Range:
¼" – 6" NPS

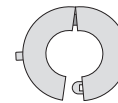

Fig. 10
with Springs

Fig. 13
with Set Screw
Stamped Steel for Pipe
Size Range:
¼" – 6" NPS

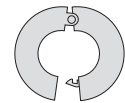

Fig. 20
with Springs
& exposed
Rivet Hinge

Stamped Steel for Pipe
Size Range:
22.5" – 6" NPS

Anvil Universal Anvilets – Pipe Fittings (Continued)

Universal Butt-weld Anvilets

Full & Reducing Sizes Class 3000 & 6000

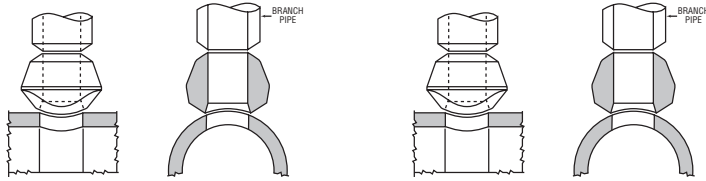

Schedule 160 & XXS

Size Range: 1/2" - 4" NPS

Standard Weight XS/XH

For Outlet Sizes: 1/8" - 24" NPS
Size Range: 1/8" - 24" NPS

Universal Flat Anvilets

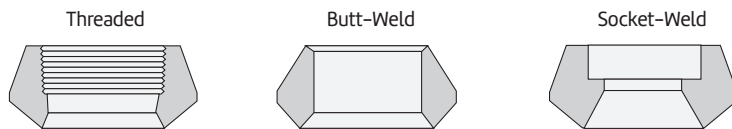

Class 3000

Threaded, Butt-weld & Socket-Weld
Size Range: 1/2" - 4" NPS (1/8" - 3/8" POA)

Universal Elbow Anvilets

Class 3000 & 6000 Butt-Weld, Threaded, and Socket-Weld

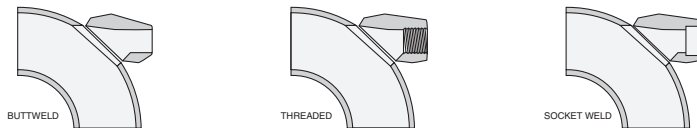

Class 3000

Threaded & Socket-Weld/Standard
& XS/XH Butt-weld
Size Range: 1/2" - 2" NPS

Class 6000

Threaded & Socket-Weld
Size Range: 1/2" - 1 1/2" NPS

Merit® Outlet Fittings

Merit 300 Tee-Let

Welding Outlet Fittings

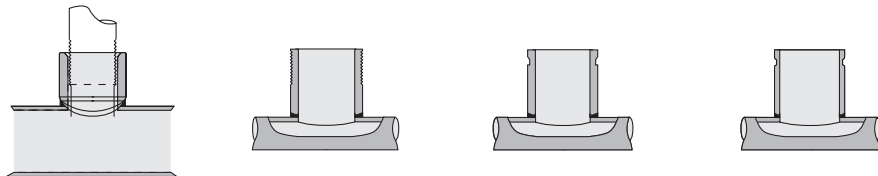

Merit 300

Female Thread
Size Range: 1/2" - 4"

Type B

Male Thread
Standard Weight
Size Range: 1" - 8"

Type C

Cut Groove
Standard Weight
Size Range: 1/4" - 8"

Type C/R

Roll Groove
Schedule 10
Size Range: 1/4" - 6"

Universal Socket-Weld Anvilets

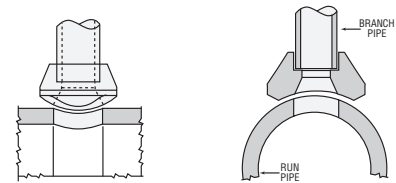

Class 3000

For Outlet Sizes: 1/2" - 4" NPS

Class 6000

For Outlet Sizes: 1/2" - 2" NPS

Universal Threaded Anvilets

Full & Reducing Sizes Class 3000 & 6000

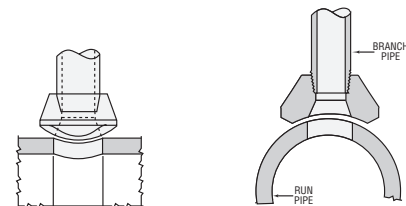

Class 3000

For Outlet Sizes: 1/8" - 4" NPS

Class 6000

For Outlet Sizes: 1/2" - 2" NPS

Universal Lateral Anvilets

Class 3000 & 6000 Butt-weld and Threaded

Lateral Anvilets provide a strong, readily attached 45° lateral outlet connection.

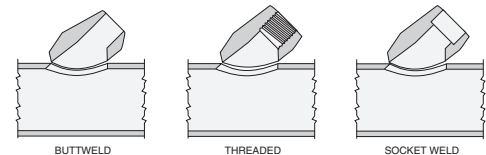

Class 3000

Standard/XS Butt-weld
Size Range: 1/2" - 2" NPS

Class 6000

Threaded/Standard
Size Range: 1/2" - 2" NPS

Eliminator

Adjustable Drop Nipples

Size Range: 1" x 1/2" thru 1" x 3/4"

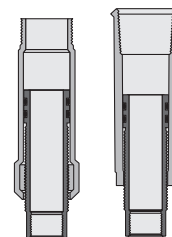

Type M

Type F

JB Smith Oil Country – Pipe Fittings (Continued)

Carbon Steel Swage Nipples



Concentric Swage Nipples
Size Range:
1/4" x 1/8" thru 1" x 3/4"
1/4" x 1/4" thru 8" x 6"



Eccentric Swage Nipples
Size Range:
1/4" x 1/8" thru 4" x 3 1/2"

Stainless Steel Swage Nipples



Stainless & Alloy Steel Swage Nipples
Size Range:
1/4" x 1/8" thru 4" x 3 1/2"

Carbon Steel Bull Plugs



Carbon Steel Bull Plugs
Size Range: 1/8" - 8"



Solid Refiner Plugs Black (Non-Plated) Carbon Steel
Size Range: 1/8" - 2"

Oil Country Fittings Tubing Swages & Casing Swages



Large End Upset Reduced to Regular or Upset
Size Range:
1" x 3/4" thru 4" x 3 1/2"



Large End Non-Upset Reduced to Upset
Size Range:
1" x 3/4" thru 4" x 3"



Swage Nipples Oil Country Tubing & Casing Non EUE Ends
Size Range: 1" - 4"



Tubing Nipples Standard Weight
Size Range: 1" - 4"



Tubing Nipples Extra Heavy Weight
Size Range: 1" - 4"

Oil Country Couplings Casing Couplings



API Casing Couplings Short Thread
Size Range: 4 1/2" - 20"



API Casing Couplings Long Thread
Size Range: 4 1/2" - 13 3/8"



Combination Couplings J-55
Size Range: 2" - 4"



Bell Nipple
Size Range: 4 1/2" - 8 5/8"



Adapter Nipples Seamless Sch. 40
Size Range: 3/4" - 12"

Oil Country Couplings Tubing Couplings



API Tubing Couplings
Size Range: 2" - 4"



Special Clearance Tubing Couplings
Size Range: 2" - 3"



Sub Tubing Couplings J-55
Size Range: 2" EUE x 2" Reg thru 4" EUE x 4" Reg

Oil Country Fittings Casing Nipples



Oil Country Casing Nipples
Size Range: 4 1/2" - 16"

Oil Country Fittings Chamber Vessels



Chambers/Pressure Vessels
Size Range: 2" - 8"

Oil Country Fittings Bull Plugs



Tubing Bull Plugs
Size Range:
3/4" EUE - 3" EUE



Casing Bull Plugs
Size Range:
4 1/2" - 10 3/4" API



API Bull Plug Female
Size Range:
3/4" EUE - 4" EUE

Oil Country Fitting Pumping Tee



Pumping Tee
Size Range: 2" 8RD EUE x 2" 8RD EUE x 2" 11 1/2" V REG - 3" 8RD EUE x 3" 8RD EUE x 3" 8V LP

Catawissa Unions – Pipe Fittings (Continued)

Hammer Unions

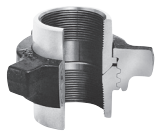

Fig. 100
Threaded Ends
1,000 psi cwp - 1,500 psi test
Size Range: 2" - 8"



Fig. 100C
Threaded Ends - Lug Union
1,000 psi cwp - 1,500 psi test
Size: 2"



Fig. 200
Threaded Ends
2,000 psi cwp - 3,000 psi test
Size Range: 1" - 6"

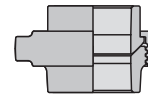

Fig. 200
Butt Weld Ends - Sch. 40
2,000 psi cwp - 3,000 psi test
Size Range: 1" - 6"



Fig. 200C
Threaded Ends - Lug Union
2,000 psi cwp - 3,000 psi test
Size Range: 1" - 2"



Fig. 206
Threaded Ends
2,000 psi cwp - 3,000 psi test
Size Range: 1" - 6"

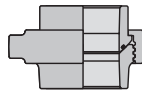

Fig. 206
Butt Weld Ends - Sch. 40
2,000 psi cwp - 3,000 psi test
Size Range: 2" - 6"



Fig. 211
Threaded Ends
Insulating Union
2,000 psi cwp - 3,000 psi test
Sizes: 1" & 2"



Fig. 300
Flat-Face Union
2,000 psi cwp - 3,000 psi test
Size Range: 1" - 4"



Fig. 301
Steam Service Union
3,000 psi cwp - 4,500 psi test
Size Range: 1" - 3"



Fig. 400
Threaded Ends
4,000 psi cwp - 6,000 psi test
Size Range: 2" - 4"

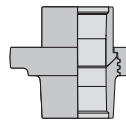

Fig. 400
Butt Weld Ends - Sch. 80
4,000 psi cwp - 6,000 psi test
Size: 2"

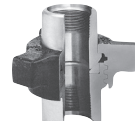

Fig. 600
Threaded Ends
6,000 psi cwp - 9,000 psi test
Size Range: 1" thru 4"



Fig. 602
Threaded Ends
6,000 psi cwp - 9,000 psi test
Size Range: 1" thru 4"

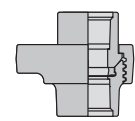

Fig. 602
Butt Weld Ends - Sch. 80
6,000 psi cwp - 9,000 psi test
Size Range: 2" thru 4"

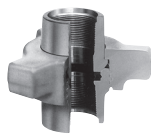

Fig. 607
Threaded Ends
Well Service Union
2,000 psi cwp - 3,000 psi test
Sizes: 1½" & 2"



Fig. 1002
Threaded Ends
10,000 psi cwp - 15,000 psi test
Size Range: 1" - 4"

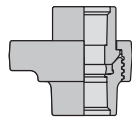

Fig. 1002
Butt Weld Ends - Sch. 160
10,000 psi cwp - 15,000 psi test
Size Range: 2" - 4"

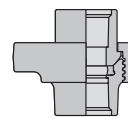

Fig. 1002
Butt Weld Ends - Sch. XXH
10,000 psi cwp - 15,000 psi test
Size Range: 2" - 4"



Fig. 1502
Threaded Ends
15,000 psi cwp - 22,500 psi test
Sizes: 2" & 3"

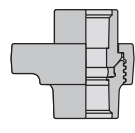

Fig. 1502
Butt Weld Ends - Sch. XXH
15,000 psi cwp - 22,500 psi test
Sizes: 2" & 3"

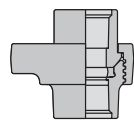

Fig. 1502
Butt Weld Ends - Sch. 160
15,000 psi cwp - 22,500 psi test
Sizes: 2" & 3"



Fig. 202
Blanking Cap Only
with O-Ring
Size: 4"



Fig. 31A
High Speed Union
3,000 psi cwp - 4,500 psi test
Size Range: 1" - 3"



Fig. 3L31A
Tri-Lug High Speed Union
3,000 psi cwp - 4,500 psi test
Size Range: 1" - 2"

Forged Steel Unions

Manufactured to MSS Standard Practice SP83 (Class 6000 by method of MSS SP83).

CLASS 3000
Fig. 2125 Threaded
Fig. 2126 Socket-Weld
Size Range: ½" - 3" NPS

CLASS 6000
Fig. 2127 Threaded
Fig. 2128 Socket-Weld
Size Range: ¼" - 2" NPS

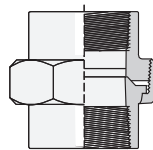

THREADED

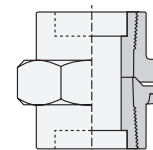

SOCKET WELD

Forged Steel Handle Bar Unions

CLASS 3000
Threaded
Size Range:
½" - 4" NPS

Pipe Hangers

Clevis Hangers and Shields



Fig. 65 (Afcon Fig. 372)
Light Duty
Adjustable Clevis
Size Range: 1/2" - 4"



Fig. CT-65
Light Duty
Adjustable Clevis
Size Range: 1/2" - 4"



Fig. 67
Pipe or Conduit Hanger
Size Range: 1/2" - 6"



Fig. 67F
Copper Tube Felt
Lined Hanger
Size Range: 1/2" - 6"



Fig. 250
MJ Hanger
Size Range: 2" - 6"



Fig. 260 (Afcon Fig. 371)
Adjustable
Clevis Hanger
Size Range: 1/2" - 30"



Fig. 260SS
Adjustable
Clevis Hanger
Size Range: 1/2" - 12"



Fig. 260 ISS
Clevis Hanger
with Insulation
Saddle System
Size Range: 2" - 16"



Fig. 300
Adjustable Clevis
for Insulated Lines
Size Range: 3/4" - 12"



Fig. 590
Adjustable Clevis
for Ductile or
Cast Iron
Size Range: 3" - 24"



Fig. 590SS
Adjustable Clevis
for Ductile or
C.I. Pipe
Size Range: 4" - 12"

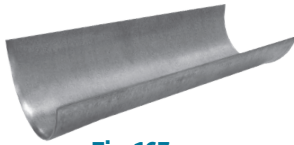

Fig. 167
Insulation Protection Shield
Size Range: 1/2" - 24" pipe with up
to 2" thick insulation



Fig. 168
Rib-Lok Shield
Size Range: 1/2" - 8" pipe or copper
tube with up to 2" thick insulation

Ceiling Plates and Flanges



Fig. 127
Plastic Ceiling Plate
Size Range: 3/8" and 1/2"



Fig. 128R
Rod Threaded, Ceiling Flange
Size Range: 3/8" and 1/2"



Fig. CT-128R
Rod Threaded Ceiling Flange
Size Range: 3/8" and 1/2"



Fig. 395
Cast Iron Ceiling Plate
Size Range: 1/2" - 8"



Fig. 153
Pipe Hanger Flange
Size Range: 3/8" - 3/4"



Fig. 610 (Afcon Fig. 610)
Ceiling Plate
Size: 3/8" rod

Ring Hangers



Fig. 69 (Afcon Fig. 300)
Adjustable Swivel Ring
Size Range: 1/2" - 8"



Fig. 69F
Adjustable Swivel
Ring Felt Lined
Size Range: 1/2" - 6"



Fig. 70 (Afcon Fig. 303)
Trapeze Pipe Hanger
Size Range: 1/2" - 4" trapeze pipe



Fig. CT-69
Adjustable Swivel Ring
Size Range: 1/2" - 4"



Fig. 104
Adjustable Swivel Ring,
Split Ring Type
Size Range: 3/4" - 8"



Fig. 108
Split Pipe Ring
Size Range: 3/8" - 8"



Fig. 138R
Extension Split Pipe Clamp
Size Range: 3/8" - 3"



Fig. CT-138R
Extension Split Tubing Clamp
Size Range: 1/2" - 2"

Pipe Hangers (Continued) Beam Clamps



Fig. 86 & 88
C-Clamp with Set
Screw and Lock Nut
Size Range: $\frac{3}{8}$ " - $\frac{3}{4}$ "



Fig. 95
C-Clamp with
Lock Nut
Sizes: $\frac{3}{8}$ " and $\frac{1}{2}$ "



Fig. 89
Retaining Clip
Size Range: $\frac{3}{8}$ " - $\frac{1}{2}$ "



Fig. 89X
Retaining Clip
Size Range: $\frac{3}{8}$ " - $\frac{3}{4}$ "



Fig. 92
Universal C-Type
Clamp Standard
Throat
Sizes: $\frac{3}{8}$ " and $\frac{1}{2}$ "



Fig. 93
(Afccon Fig. 100)
Universal C-Type
Clamp Wide Throat
Sizes: $\frac{3}{8}$ " and $\frac{1}{2}$ "



Fig. 94
Wide Throat Top
Beam C-Clamp
Sizes: $\frac{5}{8}$ " and $\frac{3}{4}$ "



Fig. 227 (Afccon Fig. 140)
Top Beam Clamp



Fig. 217
Adjustable Side
Beam Clamp
Size Range: 3" - $7\frac{5}{8}$ "

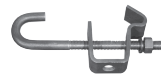

Fig. 14
Adjustable Side
Beam Clamp
Sizes: $\frac{3}{8}$ " - $\frac{5}{8}$ "



Fig. 133
Standard Duty Beam
Clamp
Size Range: 4" - 8"



Fig. 134
Heavy Duty Beam
Clamp
Size Range: 4" - 12"



Fig. 218
Malleable Beam
Clamp without
Extension Piece



Fig. 228
Universal Forged
Steel Beam Clamp



Fig. 292 & 292L
Beam Clamp with
Weldless Eye Nut

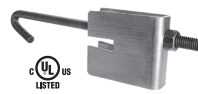

Fig. 226
(Afccon Fig. 142)
Truss Bracket

Pipe Clamps



Fig. 100
Extended Pipe Clamp
Size Range: $\frac{1}{2}$ " - 8"



Fig. 103
Offset Pipe Clamp
Size Range: $\frac{3}{4}$ " - 8"



Fig. 212 (Afccon Fig. 415)
Medium Pipe Clamp
Size Range: $\frac{1}{2}$ " - 30"



Fig. 212FP
Seismic Bracing Clamp
Size Range: $2\frac{1}{2}$ " - 12"



Fig. 216 (Afccon Fig. 420)
Heavy Pipe Clamp
Size Range: 3" - 42"



Fig. 224
Alloy Steel Pipe Clamp
Size Range: 4" - 16"

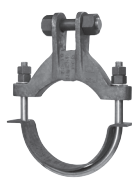

Fig. 246
Heavy Duty Alloy Steel
Pipe Clamp
Size Range: 10" - 24"



Fig. 295 (Afccon Fig. 425)
Double Bolt Pipe Clamp
Size Range: $\frac{3}{4}$ " - 36"



Fig. 295A
Alloy Double Bolt
Pipe Clamp
Size Range: $1\frac{1}{2}$ " - 24"



Fig. 295H
Heavy Duty Double Bolt
Pipe Clamp
Size Range: 6" - 36"

Riser Clamps



Fig. 40
Riser Clamp Standard
Size Range: 2" - 24"



Fig. 261 (Afccon Fig. 400)
Extension Pipe or Riser Clamp
Size Range: $\frac{3}{4}$ " - 24"



Fig. 261SS
Extension Pipe or Riser Clamp
Size Range: $\frac{1}{2}$ " - 8"



Fig. CT-121
Copper Tubing Riser Clamp
Size Range: $\frac{1}{2}$ " thru 4"

Pipe Hangers (Continued)

Concrete Inserts & Attachments



Fig. 152
Screw

Concrete Insert
Size Range: $\frac{3}{8}$ " - $\frac{7}{8}$ "

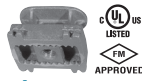

Fig. 282
Universal

Concrete Insert
Size Range: $\frac{3}{8}$ " - $\frac{7}{8}$ "



Fig. 281
Wedge Type

Concrete Insert
Size Range: $\frac{1}{4}$ " - $\frac{7}{8}$ "



Fig. 285
Light Weight

Concrete Insert
Size Range: $\frac{1}{4}$ " - $\frac{3}{4}$ "



Fig. 286

Iron Cross Design
Size Range: $\frac{3}{4}$ " - $1\frac{1}{2}$ "



Fig. 284

Metal Deck Hanger
Size Range: $\frac{3}{8}$ " - $\frac{3}{4}$ "



Fig. 52

Concrete Rod
Attachment Plate
Size Range: $\frac{3}{8}$ " - $1\frac{1}{4}$ "

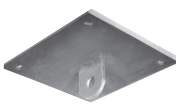

Fig. 47

Concrete Single
Lug Plate
Size Range: $\frac{1}{2}$ " - 2 "



Fig. 49

Concrete Clevis Plate
Size Range: $\frac{3}{8}$ " - $1\frac{3}{4}$ "

Stanchions & Supports



Fig. 62

Type A, B & C
Pipe Stanchion
Size Range: 2 " - 18 "



Fig. 63

Type A, B, C,
P (Afccon Fig. 772) & T
Pipe Stanchion
Size Range: $2\frac{1}{2}$ " - 42 "



Fig. 192

Adjustable Pipe
Saddle Support
Size Range: 2 " - 12 "



Fig. 220

Standard Pipe Stays
Size Range:
 $\frac{1}{2}$ " C x $\frac{3}{8}$ " IP - 2 " C



Fig. 221

Double Pipe Stays
Size Range: $\frac{1}{2}$ " C x $\frac{3}{8}$ " IP
- $\frac{3}{4}$ " C x $\frac{1}{2}$ " IP



Fig. 223

Extended Pipe Stays
Size Range: $\frac{1}{2}$ " C x $\frac{3}{8}$ " IP
- $1\frac{1}{4}$ " C x 1 " IP



Fig. 191

Adjustable Pipe
Saddle with U-Bolt
Size Range: 2 " - 12 "



Fig. 258

Stanchion Pipe
Saddle Support
Size Range: 4 " - 36 "



Fig. 259

Pipe Saddle Support
with U-Bolt
Size Range: 4 " - 36 "



Fig. 264
(Afccon Fig. 707)

Adjustable Pipe
Saddle Support
Size Range: $2\frac{1}{2}$ " - 36 "



Fig. 265
(Afccon Fig. 708)

Adjustable Pipe
Saddle Support with
U-Bolt
Size Range: 4 " - 36 "

Rods & Eye Rods



Fig. 142
(Afccon Fig. 920)

Coach Screw Rods
Machine Threaded on
Opposite End
Sizes: $\frac{3}{8}$ " and $\frac{1}{2}$ "



Fig. 146
(Afccon Fig. 650)

Continuous Thread
Sizes: $\frac{1}{4}$ " - $1\frac{1}{2}$ "



Fig. 140
(Afccon Fig. 660)

Machine Threaded
Rods Threaded on
Both Ends (Right Hand
Threads)
Sizes: $\frac{3}{8}$ " - 5 "



Fig. 253

Machine Threaded
Rods Threaded on
Both Ends
(Right & Left Hand Threads)
Sizes: $\frac{3}{8}$ " - 5 "



Fig. 148

Rod with Eye End
Size Range: $2\frac{3}{4}$ " - 5 "



Fig. 248 & 248L
(Afccon Fig. 680)

Threaded Eye Rod,
Not Welded
Size Range: $\frac{3}{8}$ " - $2\frac{1}{2}$ "



Fig. 248X

Linked Eye Rods
(Not Welded)
Size Range: $\frac{3}{8}$ " - $2\frac{1}{2}$ "



Fig. 278 & 278L
(Afccon Fig. 681)

Welded Eye Rod
Size Range: $\frac{3}{8}$ " - $2\frac{1}{2}$ "



Fig. 278X

Linked Eye Rods
Welded
Size Range: $\frac{3}{8}$ " - $2\frac{1}{2}$ "

Rod Couplings & Turnbuckles



**Fig. 135, 135i,
135E & 135R**

Straight or Reducing
Rod Coupling
Size Range: $\frac{1}{4}$ " - 1 "



Fig. 136 & 136R

Straight or Reducing
Rod Coupling
Size Range: $\frac{1}{4}$ " - 1 "



Fig. 114

Turnbuckle Adjuster
Size Range: $\frac{1}{4}$ " - $\frac{3}{4}$ "



Fig. 220

Standard Pipe Stays
Size Range:
 $\frac{1}{2}$ " C x $\frac{3}{8}$ " IP - 2 " C



Fig. 221

Double Pipe Stays
Size Range: $\frac{1}{2}$ " C x $\frac{3}{8}$ " IP
- $\frac{3}{4}$ " C x $\frac{1}{2}$ " IP



Fig. 223

Extended Pipe Stays
Size Range: $\frac{1}{2}$ " C x $\frac{3}{8}$ " IP
- $1\frac{1}{4}$ " C x 1 " IP



Fig. 191

Adjustable Pipe
Saddle with U-Bolt
Size Range: 2 " - 12 "



Fig. 258

Stanchion Pipe
Saddle Support
Size Range: 4 " - 36 "



Fig. 259

Pipe Saddle Support
with U-Bolt
Size Range: 4 " - 36 "



Fig. 264
(Afccon Fig. 707)

Adjustable Pipe
Saddle Support
Size Range: $2\frac{1}{2}$ " - 36 "



Fig. 265
(Afccon Fig. 708)

Adjustable Pipe
Saddle Support with
U-Bolt
Size Range: 4 " - 36 "



Fig. 230

Turnbuckle
Size Range: $\frac{3}{8}$ " - $2\frac{1}{2}$ "



Fig. 233

Turnbuckle
Size Range: $1\frac{1}{4}$ " - 5 "

Trapeze



Fig. 46

Universal Trapeze
Assembly



Fig. 45

Channel Assembly



Fig. 50

Equal Leg Angle for
Trapeze Assembly

Pipe Hangers (Continued)

Wall Brackets



Fig. 194 (Afccon Fig. 770)
Light Welded Steel Bracket



Fig. 195
Medium Welded Steel Bracket



Fig. 199
Heavy Welded Steel Bracket



Fig. 202
Iron Side Beam Bracket
Size Range: $\frac{3}{8}$ " - $\frac{5}{8}$ "



Fig. 206 (Afccon Fig. 556/560/565)
Steel Side Beam Bracket
Size Range: $\frac{3}{8}$ " - $\frac{5}{8}$ "



Fig. 207 (Afccon Fig. 553/555)
Threaded Steel Side Beam Bracket
Sizes: $\frac{3}{8}$ " and $\frac{1}{2}$ "



Fig. 550 (Afccon Fig. 550)
Revolver Swivel
Size: $\frac{3}{8}$ " rod



Fig. 551 (Afccon Fig. 551)
Revolver Bracket
Size: $\frac{3}{8}$ " rod

Swivel Attachments



Fig. 110R
Socket, Threaded Rod
Size Range: $\frac{1}{4}$ " - $\frac{7}{8}$ "



Fig. 157
Extension Piece
Size Range: $\frac{3}{8}$ " - $\frac{7}{8}$ "



Fig. 290 & 290L
Weldless Eye Nut
Size Range: $\frac{3}{8}$ " - $2\frac{1}{2}$ "



Fig. 299
Forged Steel Clevis
Size Range: $\frac{3}{8}$ " - 4"

Guides & Slides



Fig. 212
Medium Pipe Clamp
Size Range: 2" - 30"



Fig. 255
Pipe Alignment Guide
Size Range: 1" - 24" pipe and Insulation Thickness of 1" - 4"



Fig. CT-255
Copper Tubing Alignment Guide
Size Range: 1" - 4"



Fig. 256
Pipe Alignment Guide
Size Range: 1" - 24" pipe and Insulation Thickness of 1" - 4"



Fig. 257 & 257A
Structural Tee Slide Assembly
Size Range: All Sizes within Maximum Load Rating

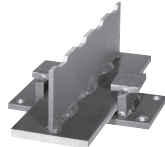

Fig. 436 & 436A
Fabricated Tee Slide Assembly
Size Range: All Sizes within Maximum Load Rating

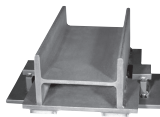

Fig. 439 & 439A
Structural "H" Slide Assembly
Size Range: 6" - 36"



Fig. 432
Special Clamp
Size Range: 2" - 24"

Welded Attachments

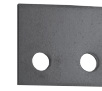

Fig. 54
Two Hole Welding Beam Lug
Size Range: $\frac{1}{2}$ " - $2\frac{1}{4}$ "



Fig. 55 & 55L
Structural Welding Lug
Size Range:
Fig. 55: $\frac{1}{2}$ " - $3\frac{3}{4}$ "
Fig. 55L: $\frac{1}{2}$ " - 2"

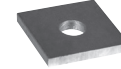

Fig. 60 (Afccon Fig. 962)
Steel Washer Plate
Size Range: $\frac{3}{8}$ " - $3\frac{3}{4}$ "



Fig. 66
Welded Beam Attachment
Size Range: $\frac{3}{8}$ " - $3\frac{1}{2}$ "



Fig. 112 & 113
Brace Fitting Complete
Sizes: 1" and $1\frac{1}{4}$ "

AWWA



Fig. 590
Adjustable Clevis for Ductile or Cast Iron
Size Range: 3" - 24"



Fig. 590SS
Adjustable Clevis for Ductile or C.I. Pipe
Size Range: 4" - 12"



Fig. 595 (Afccon Fig. 850) & 594
Socket Clamp for Ductile Iron or Cast Iron Pipe & Socket Clamp Washer
Size Range: 4" - 24" pipe



Fig. 600 & 599
Socket Clamp for Ductile Iron or Cast Iron Pipe & Socket Clamp Washer
Size Range: 4" - 24" pipe

Hardware & Accessories



Fig. 291
Clevis Pin with Cotter Pins
Size Range: $\frac{1}{2}$ " - 4"



Machine Bolts and Hex Nuts

Pipe Hangers (Continued)

U-Bolts & Straps



Fig. 120
Light Weight
U-Bolt
Size Range:
1/2" - 10"



Fig. 137 & 137S
Standard
U-Bolt
Size Range:
1/2" - 36"



Fig. 137C
Plastic Coated
U-Bolt
Size Range:
1/2" - 8"



Fig. 137SS
Stainless Steel
U-Bolt
Size Range:
1/2" - 12"



Fig. 126
One-Hole
Clamp
Size Range:
3/8" - 4"



Pipe Strap - Square
Size Range:
1/2" - 6" pipe



Fig. 244
Pipe Strap - Round
Size Range:
1/2" - 6" pipe



(Afcon Fig. 500)
Strap Short
Size Range: 1/2" - 4"



Fig. 266
Light Duty Two Hole
Pipe Strap
Size Range: 3/8" - 4"

CPVC



Fig. 69
(Afcon Fig. 300)
Adjustable
Swivel Ring
Size Range: 1/2" - 8"



Fig. 184 (Afcon Fig. 515)
Double Offset
Hanger & Restrainer
Size Range: 3/4" - 1"



Fig. 185 (Afcon Fig. 513)
One Hole Pipe Strap
Size Range: 3/4" - 2"



Fig. 186
(Afcon Fig. 510)
Two Hole Pipe Strap
Size Range: 3/4" - 2"



Fig. 187 (Afcon Fig. 511)
Two Hole 90° Side
Mount Strap
Size Range: 3/4" - 1"



Fig. 188
Two Hole Standoff Strap
Size Range: 3/4" - 2"



Fig. 188R (Afcon Fig. 514)
Two Hole Standoff & Restrainer
Size Range: 3/4" - 2"

Snubbers



Fig. 3306 & 3307
Hydraulic Shock &
Sway Suppressor
(Snubber)
Size Range: Seven
Standard Sizes with
Load Ratings from 350
to 120,000 (LBS).



Fig. 312
Tapered Pin
Size Range: 3/8" - 2 1/2"

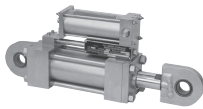

**Fig. 200 & C-200 /
Fig. 201 & C-201**
Hydraulic Shock &
Sway Suppressor
(Snubber)
Size Range: Nine
standard sizes with load
ratings from 3,000 (LBS)
to 128,000 (LBS).



Snubber Fluid
Size Range: 3/8" - 2 1/2"

Sway Strut Assembly



**Fig. 211, C-211,
640, C-640**
Sway Strut Assembly



Fig. 222 & C-222
Mini-Sway Strut
Assembly

Spring Hangers



Fig. 82 & C-82
Short Spring



Fig. B-268 & C-268
Standard Spring

Triple Spring,
Triple Spring-CR



Fig. 98 & C-98
Double Spring

Quadruple Spring,
Quadruple Spring-CR

Constant Supports



Model R 80-V
Vertical Constant
Support

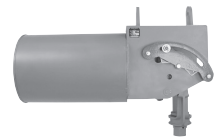

Model R 81-H
Horizontal Constant
Support

Vibration Control & Sway Brace



Fig. 296, 297, 298, 301, 302 & 303
Sway Brace
Size Range: Pre-Loads from 50 to 1,800 Pounds &
maximum forces from 200 to 7,200 Pounds.

Pipe Hangers (Continued)

Pipe Rolls & Saddles



Fig. 171
Single Pipe Roll
Size Range: 1" - 30"



Fig. 175
Roller Chair
Size Range: 2" - 30" pipe



Fig. 177
Adjustable Pipe Roll Support
Size Range: 1" - 30"



Fig. 178
Spring Cushion Hanger



Fig. 181
Adjustable Steel Yoke Pipe Roll
Size Range: 2½" - 24"



Fig. 271
Pipe Roll Stand
Size Range: 2" - 42"



Fig. 274, 274P & 275
Adjustable Pipe Roll Stand
Size Range: 2" - 42"



Fig. 277
Pipe Roll & Base Plate
Size Range: 2" - 24"

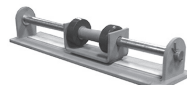

Fig. 75LL
Longitudinal & Lateral Roller

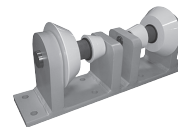

Fig. 76CP
Non-Conductive Roller

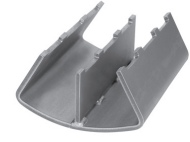

Fig. 160 to 166A
Pipe Covering Protection Saddle
Size Range: ¾" - 36"

Seismic Braces



Fig. AF001
(Anvil Fig. 770 & Afcon Fig. 001/020)
Q Brace Clamp
Size Range: 1" - 6"
Service Pipe



Fig. AF035
(Afcon Fig. 035)
Model K Brace Clamp
Size Range: 1" - 12"
Service Pipe



Fig. AF075 (Afcon Fig. 075)
Sway Brace Swivel Attachment
Size Range: 1" - 2"
Sch. 40 Brace Pipe

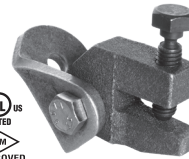

Fig. AF076 (Afcon Fig. 076)
Sway Brace Swivel Attachment
Size Range: 1" - 2"
Sch. 40 Brace Pipe



Fig. AF077
(Afcon Fig. 077)
Sway Brace Swivel Attachment
Size Range: 1" - 1¼"
Sch. 40 Brace Pipe



Fig. AF085 (Afcon Fig. 085)
Joist Adapter
Size Range: ½" - 1¼"
Joist Gap



Fig. AF086
(Afcon Fig. 086)
Adjustable Structural Attachment
Size Range: Flange Thickness up to ½" thick (UL), up to ¾" thick (FM)



Fig. AF087
(Afcon Fig. 087)
Structural Brace Attachment
Size Range: Flange Thickness up to ½" thick (UL), up to ¾" thick (FM)

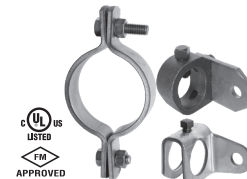

Fig. AF411, AF074, AF078
(Afcon Fig. 411, 074, 078)
Longitudinal Seismic Clamp & Brace Attachments
Size Range: 1" - 10"
Service Pipe



Fig. AF771
(Anvil Fig. 771)
Sway Brace Swivel Attachment
Size Range: 1" and 1¼"
Brace Pipe

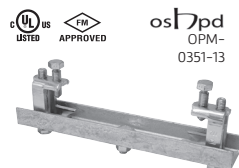

Fig. AF772 (Anvil Fig. 772)
Adjustable Steel Beam Attachment
Size Range: 4" - 15"
Beam Widths



Fig. AF775 (Anvil Fig. 775)
Longitudinal & Lateral Seismic Clamp
Size Range: 2½" - 8"
Service Pipe



Fig. AF776 (Anvil Fig. 776)
Brace Clamp
Size Range: 2½" - 8"
Service Pipe

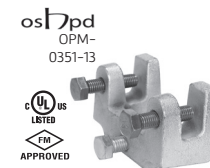

Fig. AF778 (Anvil Fig. 778)
Universal Structural Brace Attachment
Size Range: up to ¾"
Flange Thickness



Fig. AF779
(Anvil Fig. 779 & Afcon Fig. 080)
Multi-Connector Adapter
Size Range: up to 12"
Service Pipe

Pipe Hangers (Continued)

Seismic Restraints



Fig. AF090
(Anvil Fig. 89X
& Afcon Fig. 160)
Restraining Strap
Size Range: $\frac{3}{8}$ " - $\frac{3}{4}$ "
Threaded Rod



Fig. AF090R
(Afcon Fig. 162)
Retrofit Restraining Strap
Size Range: $\frac{3}{8}$ " and $\frac{1}{2}$ "
Threaded Rod

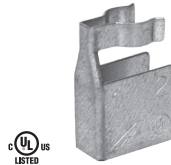

Fig. AF310
(Afcon Fig. 310)
Surge Restrainer
Size Range: 1" - 2" Fig. 69,
Swivel Ring Hanger



Fig. AF773
(Anvil Fig. 773)
Surge Restrainer
Size Range: $\frac{3}{4}$ " thru 2" Fig. 69,
Swivel Ring Hanger



Fig. AF777
(Anvil Fig. 777
& Afcon Fig. 615)
Swivel Attachment
Size Range: $\frac{3}{8}$ " and $\frac{1}{2}$ " Rod



Channels

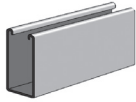

AS 100
Channel
Size: 1 7/8" x 3 3/4" x 12 GA.

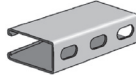

AS 100EH
Channel with Elongated Holes
Size: 1 7/8" x 3 3/4" x 12 GA.
9/16" x 1 1/8" Elongated Holes on 2" Centers.

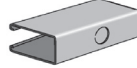

AS 100KO
Channel with Knock Outs
Size: 1 7/8" x 3 3/4" x 12 GA.
7/8" Knock Outs on 6" Centers.

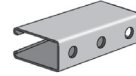

AS 100H
Channel with Holes
Size: 1 7/8" x 3 3/4" x 12 GA.
9/16" Holes on 1 7/8" Centers.

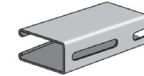

AS 100S
Channel with Long Slots
Size: 1 7/8" x 3 3/4" x 12 GA.
1 3/32" x 3" Slots on 4" Centers

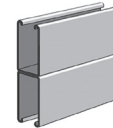

AS 100BTB
Welded Channel
Size: 1 7/8" x 6 1/2" x 12 GA.
Two Pcs. AS 100 Welded Back-to-Back.

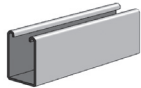

AS 150
Channel
Size: 1 5/8" x 2 7/16" x 12 GA.

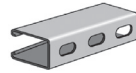

AS 150EH
Channel with Elongated Holes
Size: 1 5/8" x 2 7/16" x 12 GA.
9/16" x 1 1/8" Elongated Holes on 2" Centers.

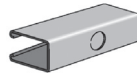

AS 150KO
Channel with Knock Outs
Size: 1 5/8" x 2 7/16" x 12 GA.
1 1/8" Knock Outs on 6" Centers.

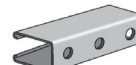

AS 150H
Channel with Holes
Size: 1 5/8" x 2 7/16" x 12 GA.
9/16" Holes on 1 7/8" Centers.

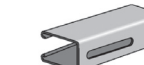

AS 150S
Channel with Long Slots
Size: 1 5/8" x 2 7/16" x 12 GA.
1 3/32" x 3" Slots on 4" Centers.

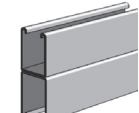

AS 150BTB
Welded Channel
Size: 1 5/8" x 4 7/8" x 12 GA.
Two Pcs. AS 150 Welded Back-to-Back.

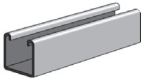

AS 200
Channel
Size: 1 7/8" x 1 7/8" x 12 GA.

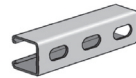

AS 200EH
Channel with Elongated Holes
Size: 1 7/8" x 1 7/8" x 12 GA.
9/16" x 1 1/8" Elongated Holes on 2" Centers.

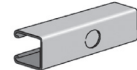

AS 200KO
Channel with Knock Outs
Size: 1 7/8" x 1 7/8" x 12 GA.
7/8" Knock Outs on 6" Centers.

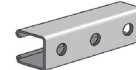

AS 200H
Channel with Holes
Size: 1 7/8" x 1 7/8" x 12 GA.
9/16" Holes on 1 7/8" Centers.

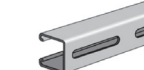

AS 200S
Channel with Long Slots
Size: 1 7/8" x 1 7/8" x 12 GA.
1 3/32" x 3" Slots on 4" Centers.

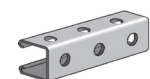

AS 200H3
Channel with Holes on all Three Sides
Size: 1 7/8" x 1 7/8" x 12 GA.
9/16" Holes on all three sides are on 1 7/8" Centers.

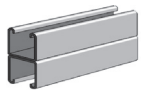

AS 200BTB
Welded Channel
Size: 1 7/8" x 3 1/4" x 12 GA.
Two Pcs. AS 200 Welded Back-to-Back.

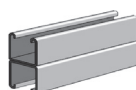

AS 200EH BTB
Welded Channel
Size: 1 7/8" x 3 1/4" x 12 GA.
Two Pcs. AS 200EH Welded Back-to-Back.
9/16" x 1 1/8" Elongated Holes on 2" Centers.

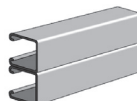

AS 200STS
Welded Channel
Size: 1 7/8" x 3 1/4" x 12 GA.
Two Pcs. AS 200 Welded Back-to-Back.

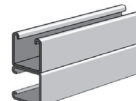

AS 200BTS
Welded Channel
Size: 1 7/8" x 3 1/4" x 12 GA.
Two Pcs. AS 200 Welded Side-to-Back.

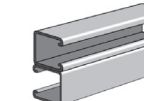

AS 200STSR
Welded Channel
Size: 1 7/8" x 3 1/4" x 12 GA.
Two Pcs. AS 200 Welded Side-to-Opposite Side.

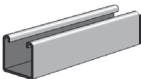

AS 210
Channel
Size: 1 7/8" x 1 7/8" x 14 GA.

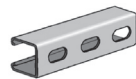

AS 210EH
Channel with Elongated Holes
Size: 1 7/8" x 1 7/8" x 14 GA.
9/16" x 1 1/8" Elongated Holes on 2" Centers.

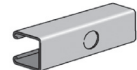

AS 210KO
Channel with Knock Outs
Size: 1 7/8" x 1 7/8" x 14 GA.
7/8" Knock Outs on 6" Centers.

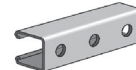

AS 210H
Channel with Holes
Size: 1 7/8" x 1 7/8" x 14 GA.
9/16" Holes on 1 7/8" Centers.



AS 210S
Channel with Long Slots
Size: 1 7/8" x 1 7/8" x 14 GA.
1 3/32" x 3" Slots on 4" Centers.

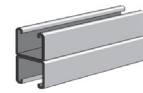

AS 210BTB
Welded Channel
Size: 1 7/8" x 3 1/4" x 14 GA.
Two Pcs. AS 210 Welded Back-to-Back.

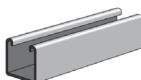

AS 300
Channel
Size: 1 7/8" x 1 3/8" x 12 GA.

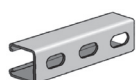

AS 300EH
Channel with Elongated Holes
Size: 1 7/8" x 1 3/8" x 12 GA.
9/16" x 1 1/8" Elongated Holes on 2" Centers.



AS 300KO
Channel with Knock Outs
Size: 1 7/8" x 1 1/8" x 12 GA.
7/8" Knock Outs on 6" Centers.

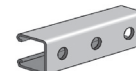

AS 300H
Channel with Holes
Size: 1 5/8" x 1 3/8" x 12 GA.
9/16" Holes on 1 7/8" Centers.

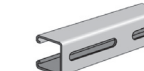



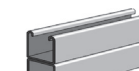





AS 300S
Channel with Long Slots
Size: 1 5/8" x 1 3/8" x 12 GA.
1 3/32" x 3" Slots on 4" Centers.

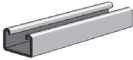

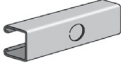
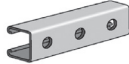
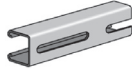
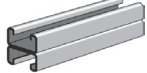

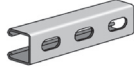
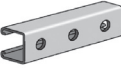
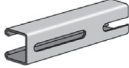
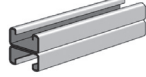

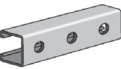
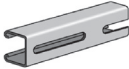
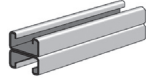

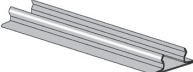
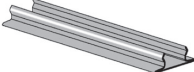



AS 300BTB
Welded Channel
Size: 1 5/8" x 2 3/4" x 12 GA.
Two Pcs. AS 300 Welded Back-to-Back.

Anvil-Strut® (Continued)



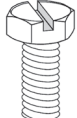

Channels (Continued)

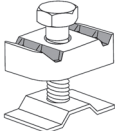
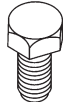
 AS 400 Channel Size: 1 5/8" x 1" x 12 GA.	 AS 400EH Channel with Elongated Holes Size: 1 5/8" x 1" x 12 GA. 9/16" x 1 1/8" Elongated Holes on 2" Centers.	 AS 400KO Channel with Knock Outs Size: 1 5/8" x 1" x 12 GA. 7/8" Knock Outs on 6" Centers.	 AS 400H Channel with Holes Size: 1 5/8" x 1" x 12 GA. 9/16" Holes on 1 7/8" Centers.	 AS 400S Channel with Long Slots Size: 1 5/8" x 1" x 12 GA. 1 3/32" x 3" Slots on 4" Centers.	 AS 400BTB Welded Channel Size: 1 5/8" x 2" x 12 GA. Two Pcs. AS 400 Welded Back-to-Back.
 AS 500 Channel Size: 1 5/8" x 1 3/16" x 14 GA.	 AS 500EH Channel with Elongated Holes Size: 1 5/8" x 1 3/16" x 14 GA. 9/16" x 1 1/8" Elongated Holes on 2" Centers.	 AS 500H Channel with Holes Size: 1 5/8" x 1 3/16" x 14 GA. 9/16" Holes on 1 7/8" Centers.	 AS 500S Channel with Long Slots Size: 1 5/8" x 1 3/16" x 14 GA. 1 3/32" x 3" Slots on 4" Centers.	 AS 500BTB Welded Channel Size: 1 5/8" x 1 3/16" x 14 GA. Two Pcs. AS 500 Welded Back-to-Back.	
 AS 520 Channel Size: 1 5/8" x 1 3/16" x 12 GA.	 AS 520EH Channel with Elongated Holes Size: 1 5/8" x 1 3/16" x 12 GA. 9/16" x 1 1/8" Elongated Holes on 2" Centers.	 AS 520H Channel with Holes Size: 1 5/8" x 1 3/16" x 12 GA. 9/16" Holes on 1 7/8" Centers.	 AS 520S Channel with Long Slots Size: 1 5/8" x 1 3/16" x 12 GA. 1 3/32" x 3" Slots on 4" Centers.	 AS 520BTB Welded Channel Size: 1 5/8" x 1 3/16" x 12 GA. Two Pcs. AS 520 Welded Back-to-Back.	
 AS 560 Channel Size: 1 5/8" x 1 3/16" x 16 GA.	 AS 560EH Channel with Elongated Holes Size: 1 5/8" x 1 3/16" x 16 GA. 9/16" x 1 1/8" Elongated Holes on 2" Centers.	 AS 707 Metal Raceway Closure Strip For All 1 5/8" Width Channels. (10' Length)	 AS 707P Metal Painted Closure Strip For All 1 5/8" Width Channels. (10' Length)		

Channel Hardware

 AS 3281 Double Conveyor Adjusting Nut Use with all 1 5/8" wide channel	 AS 83 Hexagon Nut	 Fig. 135 Rod Coupling	 Fig. 146 Continuous Threaded Rod
 AS 209 Flat Washer	 AS 203 Linked Eyelet with Stud	 AS 211 Lock Washer	 AS 230 Fender Washer
 AS 6075 Slotted Hex Head Machine Screw	 AS 6108 Square Nut	 AS 3500 Seismic Rod Stiffener	 AS 6024 Hex Head Cap Screw

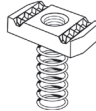
Channel Nuts

 AS NS - Clamping Nut without Spring Use with all 1 5/8" wide channel	 AS SS - Clamping Nut with Short Spring Use with AS 400 and AS 500
 AS RS - Clamping Nut with Regular Spring Use with AS 200, AS 210 and AS 300	 AS LS - Clamping Nut with Long Spring Use with AS 100 & AS 150
 ASTG - Top Grip Nut with Spring on Top Use with all 1 5/8" wide channel	 AS 517 Stud Nut with RS Spring

Anvil-Strut® (Continued)

Clamps & Accessories

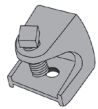

AS 85
Rod or Insulator Support



Fig. 86
Clamp with Lock Nut



Fig. 93
Top Beam "C" Clamp
Size Range: 3/8" - 1/2"



Fig. 94
Top Beam "C" Clamp
Size Range: 5/8" - 3/4"



Fig. 95
Clamp with Lock Nut

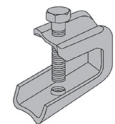

AS 135X
Light Duty Beam Clamp

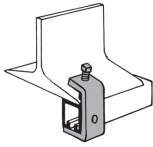

AS 684
Beam Clamp

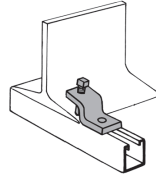

AS 685
Beam Clamp

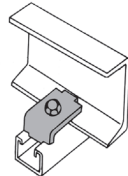

AS 686
Beam Clamp

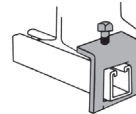

AS 855
Angular "C" Beam Clamp
AS 855 1 - Use with AS 200 and AS 210.
AS 855 2 - Use with AS 500.



AS 858
Heavy Duty Suspension Rod Beam Clamp
Safety Anchor Strap
AS 871 sold separately.

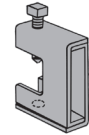

AS 865
Wide Throat Heavy Duty Beam Clamp
Safety Anchor Strap
AS 871 sold separately.



AS 871
Safety Anchor Strap
(For Heavy Duty Beam Clamps)

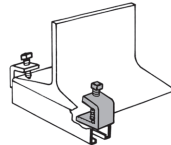

AS 907
"I" Beam Clamp
Includes Cup Point Set Screw.

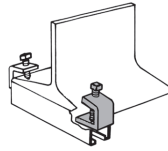

AS 998
"I" Beam Clamp
Includes Set Screw.

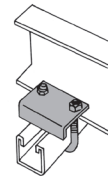

AS 2651
Beam Clamp

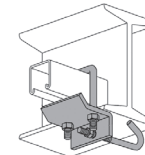

AS 2656
"U" Bolt Beam Clamp with Hook

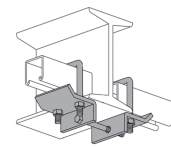

AS 2657
Double "U" Bolt Beam Clamp

Splice Clevis

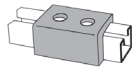

AS 631
Two Hole Splice Clevis
Use with AS 200 & AS 210.

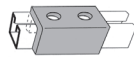

AS 644
Two Hole Splice Clevis
Use with AS 500 & AS 520.

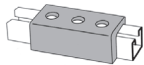

AS 629
Three Hole Splice Clevis
Use with AS 200 & AS 210.



AS 645
Three Hole Splice Clevis
Use with AS 500 & AS 520.



AS 616
Four Hole Splice Clevis
Use with AS 200 & AS 210.

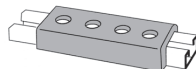

AS 646
Four Hole Splice Clevis
Use with AS 500.

Plates

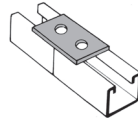

AS 601
Two Hole Splice Plate

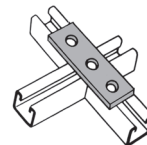

AS 602
Three Hole Splice Plate

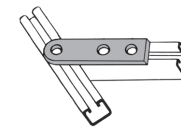

AS 617
Three Hole Swivel Plate

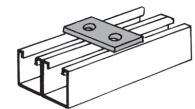

AS 620
Two Hole Connecting Plate

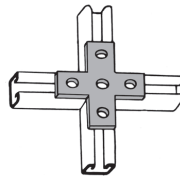

AS 712
Cross Plate

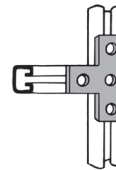

AS 714
"T" Plate

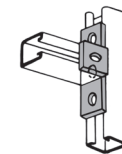

AS 715
"T" Plate - 90°

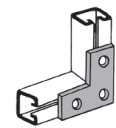

AS 718
Flat Angle Plate

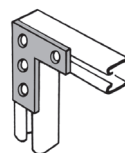

AS 719
Four Hole Corner Plate

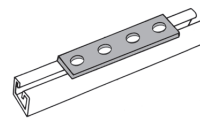

AS 888
Four Hole Splice Plate

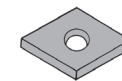

AS 619
Square Washer

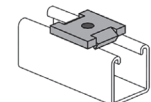

AS 2504
Square Washer with Channel Guide

Anvil-Strut® (Continued)

Angle Fittings and Connectors (Continued)

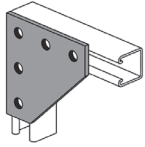

AS 2190
Flat Corner Connector

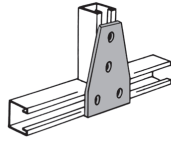

AS 747
Symmetrical Four Hole Connector

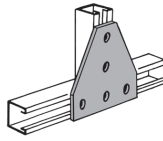

AS 854
Flat Connector

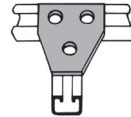

AS 925
Symmetrical Three Hole Joint Connector

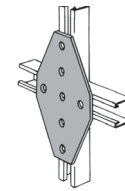

AS 2112
Cross Connector

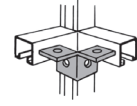

AS 665
Four Hole Double Corner Connector

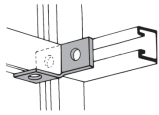

AS 720
RH & LH Angle Plate Connector

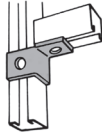

AS 922 RH & LH
Two Hole Single Corner Angle Connector

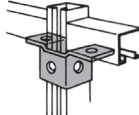

AS 923
Five Hole Two Angle Connector

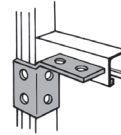

AS 2128 RH & LH
Six Hole Corner Connector

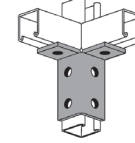

AS 666
Six Hole Double Corner Connector

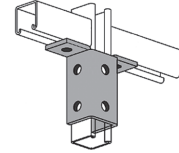

AS 821
Eight Hole Double Angle Connector

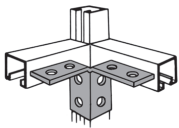

AS 667
Eight Hole Double Corner Connector

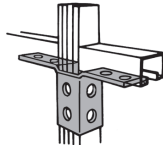

AS 913
Ten Hole Two Angle Clevis Connector

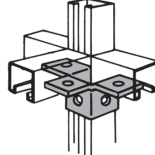

AS 668
Six Hole Three Angle Connector

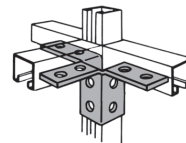

AS 669
Twelve Hole Three Angle Clevis Connector

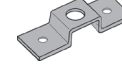

AS 2560 & AS 2561
Conduit Connector Fitting Assembly

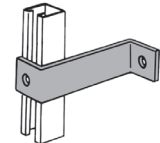

AS 3060
Offset Connector

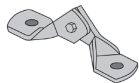

AS 9402
Two Hole Hinge Connector

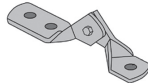

AS 9403
Three Hole Hinge Connector

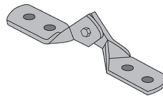

AS 9404
Four Hole Hinge Connector

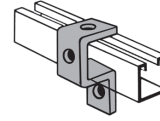

AS 677
Cup Support for Standard Single Strut
Use with AS 200 and AS 210.

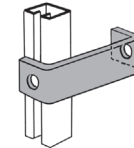

AS 993
Inside Clevis

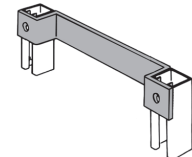

AS 2401 thru AS 2403
Ladder Rung

Post Bases

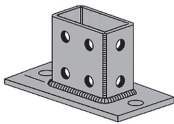

AS 2064
Double Column Post Base
Use with AS 100, AS 200BTB, AS 200STS, AS 200BTS and AS 200STR Channel.

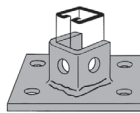

AS 3013
Single Column Post Base
Use with AS 200 and AS 210 Channel.

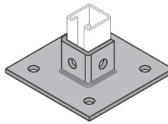

AS 3013 SQ
Single Column Post Base
Use with AS 200 and AS 210 Channel.

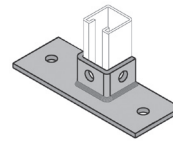

AS 3013 FL
Single Column Post Base
Use with AS 200 and AS 210 Channel.

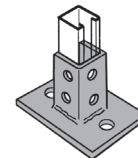

AS 3025
Post Base
Use with AS 200 and AS 210 Channel.

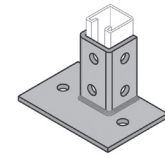

AS 3025 FL
Post Base
Use with AS 200 and AS 210 Channel.

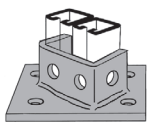

AS 3029
Double Column Post Base
Use with all 3/4" Channels.

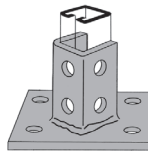

AS 3033
Post Base
Use with AS 200 and AS 210 Channel.

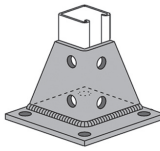

AS 3040
Post Base
Use with AS 200 and AS 210 Channel.

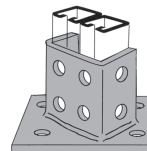

AS 3064
Double Column Post Base
Use with all 3/4" Channels.

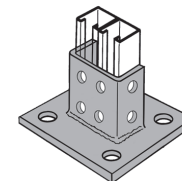

AS 3064 SQ
Double Column Post Base
Use with all 3/4" Channels.

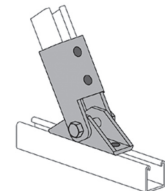

AS 9400
Adjustable Base

Anvil-Strut® (Continued)

"U" Supports

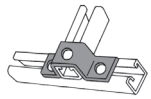

AS 613
"U" Support
Use with AS 200, AS 210
and AS 500BTB.

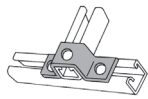

AS 679
"U" Support
Use with AS 100, AS
200BTB and AS 210BTB.

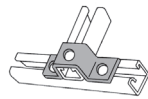

AS 710
"U" Support
Use with AS 300.

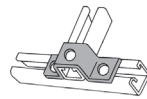

AS 929
"U" Support
Use with AS 500 & AS 520.

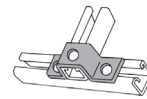

AS 978
"U" Support
Use with AS 400.

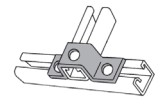

AS 2119
"U" Connector

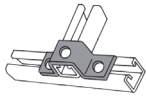

AS 2648
"U" Support
Use with AS 150.

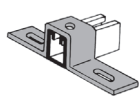

AS 687
Slotted "U" Support
Use with AS 200 & AS 210.

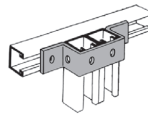

AS 721
"U" Support
Use with AS 100, AS
200BTB and AS 210BTB.

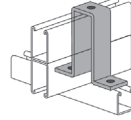

AS 678
Three Hole "U" Support
Use with AS 150BTB.

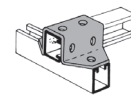

AS 733
Six Hole "U" Support
Use with AS 200 & AS 210.

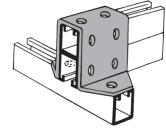

AS 735
Eight Hole "U" Support
Use with AS 200BTB.

"Z" Supports

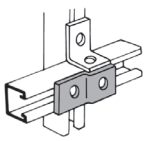

AS 609
Two Hole Offset
"Z" Support

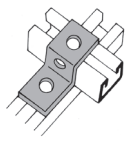

AS 611
"Z" Support
Use with AS 200, AS
210 and AS 500BTB.

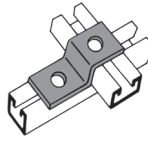

AS 612
"Z" Support
Use with AS 400.

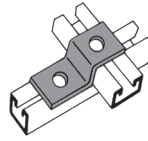

AS 711
"Z" Support
Use with AS 300.

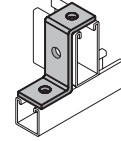

AS 756
"Z" Support
Use with AS 100, AS
200BTB & AS 210BTB.

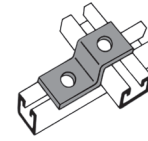

AS 928
"Z" Support
Use with AS 500 &
AS 520.

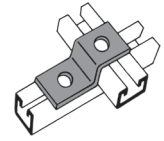

AS 2601
"Z" Support
Use with AS 150.

Angle Fittings and Connectors

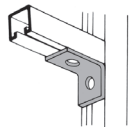

AS 603
Two Hole End Angle

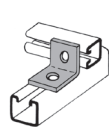

AS 604
Two Hole Corner Angle

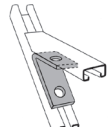

AS 624
Two Hole Closed Angle
Connector

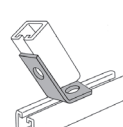

AS 633
Two Hole Open Angle
Connector



AS 763, AS 764
Slotted Adjustment
Corner Angle

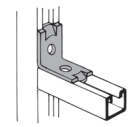

AS 806
Two Hole Angle with
Impressions on
Both Legs

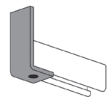

AS 921
One Hole Angle

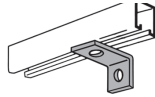

AS 2144
Corner Angle

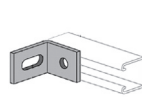

AS 2520
Two Hole
Adjustment Angle



AS 2545
Slotted 90° Angle

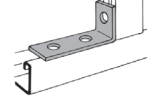

AS 605
Three Hole
Corner Angle

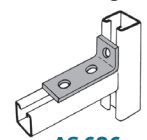

AS 606
Three Hole
Corner Angle

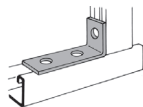

AS 745
Three Hole Corner
Angle

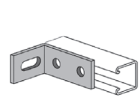

AS 3049
Two Hole Slotted 90°
Corner Connector

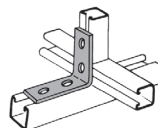

AS 607
Four Hole Corner Angle

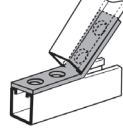

AS 781
Four Hole Open Angle
Connector

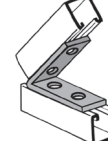

AS 793
Four Hole Closed Angle
Connector

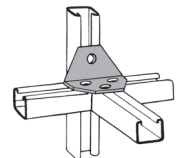

AS 614
Four Hole Joint Corner
Connector

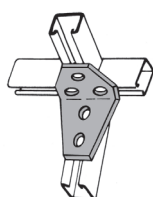

AS 615
Four Hole Shelf Joint
Angle Connector

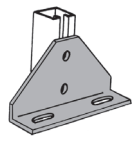

AS 689
Adjustable Double
Slotted Corner
Connector

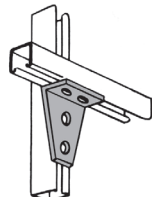

AS 748
Four Hole Corner Joint
Connector

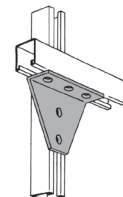

AS 927
Five Hole Corner
Connector

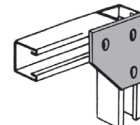

AS 744
Flat Corner Connector

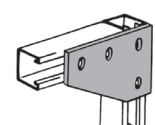

AS 750
Four Hole Corner
Connector

Anvil-Strut® (Continued)

Brackets

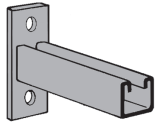

AS 651
Reversible Strut
Bracket

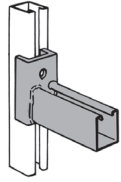

AS 661 T1
Strut Bracket
(Slot Up)

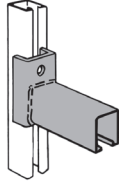

AS 661 T2
Strut Bracket
(Slot Down)

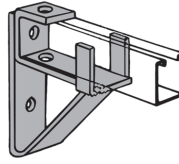

AS 708
Single Channel
Bracket Support
Use with AS 200, AS 210
and AS 500BTB.

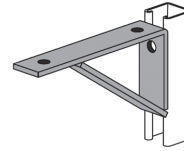

AS 732
Shelf Bracket

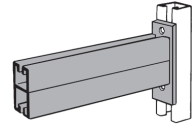

AS 809
Double Channel
Bracket

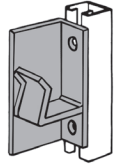

AS 825 RH/LH
Pipe Axle Support

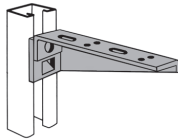

AS 838 RH/LH
6" thru 30" Shelf
Bracket

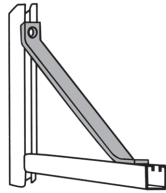

AS 926
Strut Brace

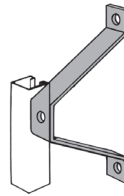

AS 2404 thru AS 2408
Wall Ladder Bracket

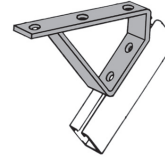

AS 2421
45° Stair Tread
Support

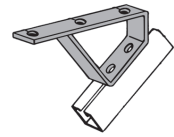

AS 2422
34½° Stair Tread
Support

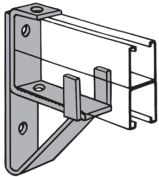

AS 3164
Double Channel
Bracket Support
Use with all 3 1/4"
Channels.

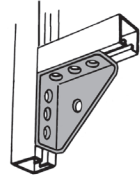

AS 3373
Universal Angle
Bracket



AS 2627
Spacer Clevis

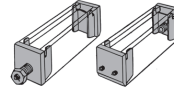

AS 2654 & AS 2654A
Column Attachment

Pipe and Conduit Supports

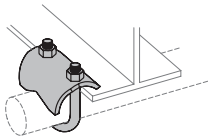

AS 51
Right Angle Pipe or
Conduit Clamp



Fig. 67
Pipe or Conduit
Hanger



Fig. 69
Swivel Ring Hanger



Fig. 137
"U" Bolt with Nuts
Long Tangent

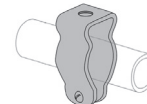

AS 270
Conduit Clamp

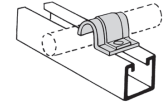

AS 1450
One Hole Clamp for
O.D. Tubing

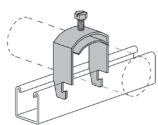

AS 3101 thru AS 3115
One Piece Cable
and Conduit Clamp

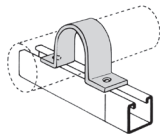

AS 3126
Hold Down Clamp

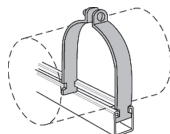

AS 1000
EMT Conduit Clamps
Offered in
Pre-Assembled only.

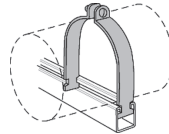

AS 1100
Rigid Steel
Conduit Clamps
Offered in
Pre-Assembled only.

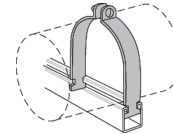

AS 1200
O.D. Tubing Clamp
Offered in
Pre-Assembled only.

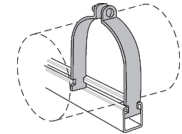

AS 1300
Universal Pipe Clamp
Offered in
Pre-Assembled only.

Trolleys & Accessories



AS 2521
Two Wheel Trolley
Use with AS 200 Channel.

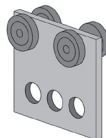

AS 2522
Four Wheel Trolley
Use with AS 200 Channel.

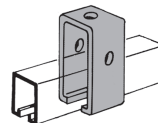

AS 2528
Trolley Beam Standard Support
Use with AS 200 and AS 210 Channel.

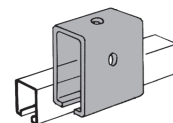

AS 2528-1
Trolley Beam Joint Support
Use with AS 200 and AS 210 Channel.

Anvil-Strut® (Continued)

Pipe and Conduit Supports (Continued)

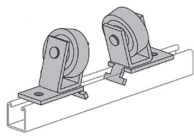

AS 815
(6" to 18" Pipe)
Double Roller Pipe Support

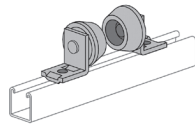

AS 1901
(1" to 8" Pipe)
Pipe Roller Support

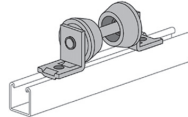

AS 1902
(1" to 8" Pipe)
Pipe Roller Support

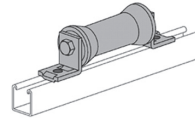

AS 1911
(2" to 14" Pipe)
Pipe Roller Support

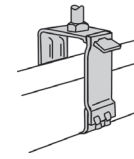

AS 2631
Swing Gate
Fixture Hanger
Use with AS 200, AS 210,
AS 300, AS 400 and
AS 500 Channels.

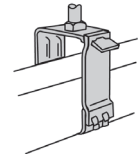

AS 2631D
Swing Gate
Fixture Hanger
Use with AS 100, AS 150,
AS 200BTB and
AS 210BTB Channels.

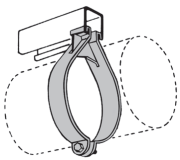

AS 3138
Parallel Pipe Clamp

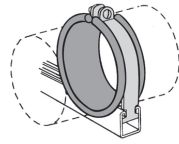

AS 3792
Cushion Strip

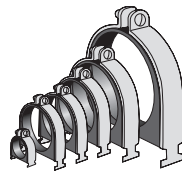

AS 0040D thru AS 106P
Cushion Clamp Assembly

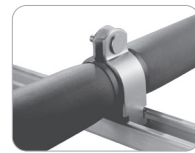

**Klo-Shure®
Strut-Mounted**
Insulation Couplings
with Strut Clamp

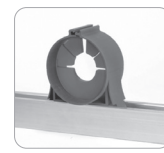

**Klo-Shure®
Strut-Mounted**
Insulation Couplings
with Non Metallic
Strut Clamp

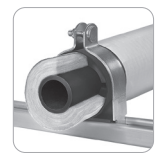

**Klo-Shure®
Strut-Mounted**
Insulation Couplings
for Fiberglass
Insulation

Concrete Inserts



Fig. 152
Screw Concrete Insert



Fig. 285
Light Weight
Concrete Insert

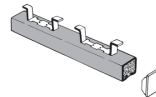

AS 349
Continuous
Concrete Insert
with or without Closure Strip
and End Cap Installed.

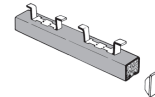

AS 449
Continuous
Concrete Insert
with or without Closure Strip
and End Cap Installed.

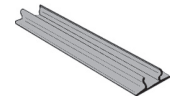

AS 6151
Plastic Closure Strip

End Caps

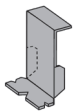

AS 653
Type "B" End
Cap Anchor
Use with AS 349 Insert.

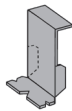

AS 654
Type "B" End
Cap Anchor
Use with AS 449 Insert.



AS 655 & AS 656
Type "A" End Cap
Use with AS 200
Channel. Use with AS
300 Channel and AS
349 Insert.



AS 901 & AS 902
Type "A" End Cap
Use with AS 100 and
AS 400 Channel.



AS 930
Type "A" End Cap
Use with AS 500
Channel.



AS 2580
Type "A" End Cap
Use with AS 150
Channel.



AS 2511
End Cap with
Knockout
AS 25111 - Use with AS 100.
AS 25112 - Use with AS 200
and AS 210.
AS 25113 - Use with AS 300.

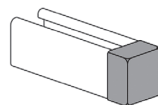

AS 6153
Safety End Cap
AS 61531 - Use with AS 100.
AS 61532 - Use with AS 200
and AS 210.
AS 61533 - Use with AS 300.
AS 61535 - Use with AS 500.

- Introduction
- Couplings
- Outlets
- Fittings
- Valves & Accessories
- High Pressure
- CTS Copper System
- DI-Electric Nipples
- Plan-End Fittings
- HDPE Couplings
- Socket-It® Fittings
- Stainless Steel Method
- Roll Groovers
- Installation & Assembly
- Special Coatings
- Design Services
- Technical Data
- Master Format 3 Part Specs.
- Pictorial Index

Fig./Model	Description	Page
64	CTS SlideLOK® Rigid Coupling	271-272; 356-357
70	SlideFLEX® Flexible Coupling	26-27; 348-349
70G	Butterfly alve	157-158
74	SlideLOK® Ready for Installation Coupling	24-25; 346-347
90G	Grooved-End Check Valve	175-176
92BPC	DZR Brass Ball Valve with Bypass	205-206
92HS	Stainless Steel Braided Hose	211-212
92ST	DZR Brass Ball Valve with Strainer	203-204
92UN	DZR Brass Union Body with Air Vent and Test Point	209-210
99IBV	Ball Valve with Nut for 9900V Series Valves	207-208
400G	Grooved-End Silent Check Valve	177-178
601	45° CTS Elbow	276, 277
610	90° CTS Elbow	276, 277
617	Transition Coupling for Joining IPS to Copper Tubing Systems	273-274; 358
618	CTS Reducing Tee (GR x GR x Cup)	276, 279
619	CTS Tee	276, 278
621	CTS Reducing Tee (GR x GR x GR)	276, 279
650	CTS Concentric Reducer (GR x GR)	276, 280
652	CTS Concentric Reducer (GR x Cup)	276, 280
660	CTS Cap	276, 278
758G	Grooved-End "Wye" Strainer	231-232
768G	Grooved-End "Wye" Strainer	233-234
770	Rigid Coupling	149-152
1007	Roll Groover	339-340
3006	Roll Groover	341-342
3007	Roll Groover	339-340
6084	CTS Copper Flange Adapter	275
6700	CTS Copper Butterfly alve	281-283
7000	Lightweight Coupling	39-41; 354
7001	Flexible Coupling	28-30; 350
7001-2	Flexible Coupling	31-32; 351-352
7003	Hingelok® Coupling	44-45; 359
7004	Coupling	257-258; 368
7004EG	High Pressure Coupling with EG® Gasket	259-260; 369
7005	Roughneck® Coupling	288-289; 365
7010	Reducing Coupling	46-47; 360
7011	Standard Coupling	33-34; 353
7012	Gruvlok Flange	50-52; 361-363
7013	Gruvlok Flange	53-57
7022	Weld Ring Gruv-Ring Coupling	35-38
7042	Outlet Coupling	61-63; 364
7043	Branch Outlet	72-73; 366
7045	Clamp-T®, FPT Branch	64-67; 365
7046	Clamp-T®, Groove Branch	68-70; 365
7047	Clamp-T®, Cross	71
7048	Clamp-T®, Cross	71
7049	Clamp-T®, Cross	71
7050	90° Elbow	74-77
7050-3D	90° Long Radius Elbow	137-140
7050-5D	90° Long Radius Elbow	141-144
7050-6D	90° Long Radius Elbow	145-148
7050DR	90° Drain Elbow	129-131
7050EG	High Pressure 90° LR Elbow	266-267
7050LR	90° Long Radius Elbow	78-81

Fig./Model	Description	Page
7050LRP	Plain End 90° Long Radius Elbow	296-297
7050P	Plain End 90° Elbow	290-291
7050RF	Reducing Base Support Elbow (GR x FL)	113-115
7051	45° Elbow	74-77
7051-3D	45° Long Radius Elbow	137-140
7051-5D	45° Long Radius Elbow	141-144
7051-6D	45° Long Radius Elbow	169-172
7051EG	High Pressure 45° LR Elbow	145, 266-267
7051LR	45° Long Radius Elbow	78-81
7051LRP	Plain End 45° Long Radius Elbow	296-297
7051P	Plain End 45° Elbow	290-291
7052	22½° Elbow	74-77
7052-3D	22½° Long Radius Elbow	137-140
7052-5D	22½° Long Radius Elbow	141-144
7052-6D	22½° Long Radius Elbow	145-148
7053	11¼° Elbow	78-81
7053-3D	11¼° Long Radius Elbow	137-140
7053-5D	11¼° Long Radius Elbow	141-144
7053-6D	11¼° Long Radius Elbow	169-172
7055	90° Adapter Elbow (GR x MPT)	113-115
7056	45° Adapter Elbow (GR x MPT)	113-115
7057-3D	60° Long Radius Elbow	137-140
7057-5D	60° Long Radius Elbow	141-144
7057-6D	60° Long Radius Elbow	145-148
7058-3D	30° Long Radius Elbow	137-140
7058-5D	30° Long Radius Elbow	141-144
7058-6D	30° Long Radius Elbow	145-148
7060	Tee	82-84
7060EG	High Pressure Tee	268-269
7060P	Plain End Tee	290-291
7061	Reducing Tee Standard	85-88
7061P	Plain End Reducing Tee	294-295
7062	Bullhead Tee Specialty Tee (GR x GR x FPT)	129-131
7063	Tee w/ Threaded Branch	89-91
7064	Reducing Tee w/ Threaded Branch	92-95
7065	Standpipe Tee (GR x GR x FPT)	129-131
7066	Tee Wye	109-112
7067	Reducing Tee Wye	109-112
7068	Cross	123-125
7068P	Plain End Cross	292-293
7069	45° Lateral	105-108
7069P	Plain End 45° Lateral	292-293
7070	45° Reducing Lateral	105-108
7071	True Wye	109-112
7071P	Plain End 90° True Wye	292-293
7072	Concentric Reducer (GR x GR)	102-104
7072GF	Concentric Reducer (GR x Flange)	116-119
7073	Eccentric Reducer	96-98
7074	Cap	123-125
7075	Bull Plug	123-125
7075P	Plain End Bull Plug	296-297
7076	Concentric Reducer (GR x THD)	109-112
7077	Swaged Nipple (GR x GR)	99-101
7077P	Plain End Swaged Nipple	300-301
7078	Swaged Nipple (GR x THD)	99-101
7079	Swaged Nipple (GR x BEV)	99-101
7080	Adapter Nipple (GR x GR)	126-128

Fig./Model	Description	Page
7080P	Adapter Nipple (Plain x GR)	298-299
7081	Adapter Nipple (GR x MPT)	126-128
7081P	Adapter Nipple (Plain x THD)	298-299
7082	Adapter Nipple (GR x BEV)	126-128
7082P	Adapter Nipple (Plain x BEV)	298-299
7084	Flange Nipple (GR x #150 FL)	120-122
7084P	Flange Nipple (Plain x #150 FL)	294-295
7085	Flange Nipple (GR x #300 FL)	120-122
7085P	Flange Nipple (Plain x #300 FL)	294-295
7086	HOSE Nipples (GR x Hose)	126-128
7087	Female Thread Adapter (GR x FPT)	113-115
7088	Di-Electric Nipple (GR x THD)	284-285
7089	Di-Electric Nipple (GR x GR)	284-285
7090	Di-Electric Nipple (THD x THD)	284-285
7091	DI-LOK® Nipple (CTS GR x IPS GR)	286-287
7097	Eccentric Reducer	96-98
7100	Sock-It® 90° Elbow	310-311
7101	Sock-It® 90° Reducing Elbow	312-313
7103	Sock-It® Straight Tee	314-315
7105	Sock-It® Reducing Outlet Tee	318-319
7106	Sock-It® Reducing Tee	320-321
7107	Sock-It® Coupling	316-317
7240	Expansion Joint	58-60
7250	Suction Diffuser	235-237
7260	Tee Strainer	229-230
7305	HDPE Coupling	302-304; 370-371
7307	HDPE Transition Coupling	305-306; 372
7312	HDPE Flange Adapter	307-309; 373
7377	Double Groove Coupling	263-265; 370
7400	Rigidlite® Coupling	42-43; 355
7001SS	Stainless Steel Flexible Coupling	322-323
7401	RigidLOK® Coupling	19-21; 346
7401-2	RigidLOK® Coupling	31-32; 351-352
7450	90° Short Pattern Elbow	132-134
7460	Short Pattern Tee	135-136
7500	Ball Valve	169-172
7662EG	High Pressure Header Tee	268-269
7700	Butterfly valve Epoxy	149-152
7788	Gruvlok Flange Adapter	48-49
7800	Check Valve	179-181
7050SS	Stainless Steel 90° Elbow	326-327
7051SS	Stainless Steel 45° Elbow	326-327
7060SS	Stainless Steel Tee	326-327
7061SS	Stainless Steel Reducing Tee	326, 328
7072SS	Stainless Steel Concentric Reducer	327, 331
7073SS	Stainless Steel Eccentric Reducer	326, 332
7074SS	Stainless Steel Cap	326, 329
7084SS	Stainless Steel Flange Adapter (Groove x Class 150)	326, 330
8100	Low Profile Butterfly valve	165-166
8000GR	Butterfly valve	153-156
	Grooved End Stainless Steel Butterfly valve	153-156
ABV-9900V	Straight DZR Brass Automatic Balancing Valve Series	207-208
ABV-S-9909	Straight DZR Brass Automatic Balancing Valve (Solder)	184-187

Fig./Model	Description	Page
ABV-T-9907	Straight DZR Brass Automatic Balancing Valve (Threaded)	184-187
AF-21-FF	Flex Connector (FL x FL)	251-252
AF-21-GF	Flex Connector (GR x FL)	249-250
AF-21-GG	Flex Connector (GR x GR)	247-248
AF-21-RFF	Reducing Flex Connector (FL x FL)	253-254
AF-21-RGF	Reducing Flex Connector (GR x FL)	255-256
B333	Large Diameter Butterfly valve with Gear Operator	162-164
B480	Grooved End Stainless Steel Butterfly valve	333-336
8100	Low Profile Butterfly valve	165-166
B8200L	PVC Butterfly valve (Spline x Spline)	167-168
BV435	Grooved End Stainless Steel Ball Valve	337-338
BV835	Grooved End Ball Valve with Lever Handle and Gear Operator	173-174
CB800	Circuit Balancing Valves	217-226
CSV-9520AB	DZR Brass On/Off Terminal Low Lead Balancing Valve Series	196-200
CSV-S-9529AB	DZR Brass On/Off Terminal Low Lead Balancing Valve (Solder)	196-200
CSV-T-9527AB	DZR Brass On/Off Terminal Low Lead Balancing Valve (Threaded)	196-200
CV890	Dual Disc Check Valve	182-183
-	Flanged Seal Rings	56-57
FTV-A	Tri-Service Valve (Angle)	227-228; 375-377
FTV-S	Tri-Service Valve (Straight)	227-228; 375-377
GAV-15	Automatic Air Vent	243-244
GAV-30	Automatic Air Vent	245-246
GBV-A	Balancing Valve (Angle)	213-216
GBV-G	Balancing Valve (Straight)	213-216
MBV-9510	Fixed Orifice Double Regulating valve Series	188-191
MBV-S-9519	Fixed Orifice Double Regulating valve (Solder)	192-195
MBV-T-9517	Fixed Orifice Double Regulating Valve (Threaded)	188-191
MBV-9510AB	Fixed Orifice Double Regulating Low Lead Valve Series	192-195
MBV-S-9519AB	Fixed Orifice Double Regulating Low Lead Valve (Solder)	188-191
MBV-T-9517AB	Fixed Orifice Double Regulating Low Lead Valve (Threaded)	192-195
S810	Suction Diffuser	238-242
	Shop-Gruv	343

About ASC Engineered Solutions

ASC Engineered Solutions is defined by quality—in its products, services and support. With more than 1,400 employees, the company's portfolio of precision-engineered piping support, valves and connections provides products to more than 4,000 customers across industries, such as mechanical, industrial, fire protection, oil and gas, and commercial and residential construction. Its portfolio of leading brands includes ABZ Valve®, AFCON®, Anvil®, Anvil EPS, Anvil Services, Basic-PSA, Beck®, Catawissa, Cooplet®, FlexHead®, FPPI®, Gruvlok®, J.B. Smith, Merit®, North Alabama Pipe, Quadrant®, SCI®, Sharpe®, SlideLOK®, SPF® and SprinkFLEX®. With headquarters in Commerce, CA, and Exeter, NH, ASC also has ISO 9001:2015 certified production facilities in PA, TN, IL, TX, AL, LA, KS, and RI.



asc-es.com

Building connections that last™

ASC-CAT-Gruvlok-Products-Submittal-Catalog-v03 | 02.23

