



THE CUBE

OI-6000-X-X-X-L-X-C

OI-6000-X-X-X-GL-X-C

Non-Explosion-Proof

Ambient Air

Wire Powered

Toxic Gas

Detector



OPERATION MANUAL REV 1.0

CAUTION

CAUTION: FOR SAFETY REASONS, THIS EQUIPMENT MUST BE OPERATED AND SERVICED BY QUALIFIED PERSONNEL ONLY. READ AND UNDERSTAND THE INSTRUCTION MANUAL COMPLETELY BEFORE OPERATING OR SERVICING.

DANGER

DANGER: OTIS INSTRUMENTS INC. OI-6000-X-X-X-X-X-C IS AN AMBIENT AIR TOXIC GAS SENSOR ASSEMBLY AND ONLY MONITORS IN THE IMMEDIATE VICINITY OF THE SENSOR HOUSING. A SITE SURVEY IS REQUIRED IN ORDER TO DETERMINE THE BEST PLACEMENT AND QUANTITY OF SENSOR ASSEMBLIES. IMPROPER INSTALLATION CAN LEAD TO AN UNDETECTABLE GAS LEAK WHICH COULD RESULT IN PERSONAL INJURY OR LOSS OF LIFE.

TABLE OF CONTENTS

1	PRODUCT OVERVIEW.....	1
1.1	INTRODUCTION	1
1.2	PRODUCT SPECIFICATIONS	2
1.3	SYSTEM DIAGRAMS.....	3
1.3.1	EXTERNAL SYSTEM DIAGRAM	3
1.3.2	INTERNAL SYSTEM DIAGRAM.....	4
1.3.3	ASSEMBLY DIAGRAM.....	5
2	INSTALLATION AND START-UP.....	6
2.1	PRODUCT PLACEMENT	6
2.2	PRODUCT MOUNTING	7
2.3	WIRING CONFIGURATIONS	7
2.3.1	OPENING THE ENCLOSURE.....	8
2.3.2	CONNECTING POWER	8
2.3.3	CONNECTING 4-20 mA OUTPUT	10
2.3.4	CONNECTING RS-485	12
2.3.5	CONNECTING PIEZO ALARM.....	14
2.3.6	CONNECTING THE FAULT TERMINAL	15
2.3.7	CONFIGURING THE LIGHT COLORS AND PIEZO ALARM ACTIVATION	16
2.3.8	CLOSING THE ENCLOSURE	17
2.4	SYSTEM START-UP	17
2.5	NORMAL OPERATING MODE.....	18
3	PRODUCT SETTINGS AND CONFIGURATION	19
3.1	ALARM TEST	19
3.1.1	PERFORMING THE ALARM TEST	20
3.2	NETWORK ID.....	20
3.3	SYSTEM INFORMATION	21
3.4	NULL/CALIBRATION TIMER INFORMATION	21
3.5	UNIT INFORMATION	22
3.6	BACKGROUND SETTING.....	22
3.7	LATCHING AND NON-LATCHING ALARM SETTINGS.....	23
3.7.1	ALARM 1: LATCHING/NON-LATCHING SETTING.....	23
3.7.2	ALARM 2: LATCHING/NON-LATCHING SETTING.....	24
3.8	CALIBRATION METHOD	24
3.9	MODBUS ADDRESS SETTING	25
3.10	MODBUS BAUD SETTING.....	26
3.11	4-20 mA OFFSET SETTINGS	27
3.11.1	ZERO OFFSET SETTING	27
3.11.2	FULL-SCALE OFFSET SETTING	28
3.12	DISPLAY SCREEN CONTRAST SETTING	28
3.13	RETURN TO FACTORY DEFAULT SETTINGS	29
3.14	RESET NULL & CALIBRATION VALUES	31

4	OPERATION SETTINGS	32
4.1	POWERING THE DEVICE	32
4.1.1	POWERING OFF	32
4.1.2	POWERING ON	32
4.2	SENSOR CALIBRATION	33
4.2.1	NULLING THE SENSOR (AUTO NULL)	33
4.2.2	CALIBRATING THE SENSOR (MANUAL CAL)	35
4.2.3	CALIBRATING THE SENSOR (AUTO CAL)	36
4.3	SENSOR ALARM SETTINGS	38
4.3.1	SENSOR LOW ALARM SETTING	38
4.3.2	SENSOR LOW ALARM RISE/FALL SETTING	39
4.3.3	SENSOR HIGH ALARM SETTING	39
4.3.4	SENSOR HIGH ALARM RISE/FALL SETTING	40
4.4	SENSOR RADIO ADDRESS	40
4.5	MANUAL RESET FOR ACTIVATED LATCHING ALARMS	41
5	PRODUCT MAINTENANCE.....	42
5.1	SCHEDULED MAINTENANCE.....	42
5.2	SENSOR REPLACEMENT	43
5.3	PRODUCT TROUBLESHOOTING	44
5.4	PRODUCT REPLACEMENT PARTS AND ACCESSORIES	45
APPENDIX A: INTRODUCTION TO 4-20 MA CURRENT LOOP SIGNALS		47
APPENDIX B: MODBUS COMMUNICATIONS.....		49
APPENDIX C: MODBUS REGISTER MAP		51
APPENDIX D: PRODUCT WARRANTY STATEMENT		53
APPENDIX E: INFORMATION ABOUT RMA SERVICE REPAIRS		55
APPENDIX F: INFORMATION ABOUT RMA RETURNS FOR CREDIT		57

1 PRODUCT OVERVIEW

1.1 INTRODUCTION

The Otis Instruments, Inc. (Otis) GEN II Model OI-6000-X-X-X-L-X-C and OI-6000-X-X-X-GL-X-C (OI-6000) Non-Explosion-Proof Ambient Air Toxic Gas Detectors are designed to detect a wide range of toxic gases in potentially hazardous environments. These OI-6000 features non-intrusive magnetic switches that allow for complete system configuration, regular calibration, and product maintenance to be performed in the field, without opening the enclosure and breaking the seal of the enclosure. Non-intrusive interface with these OI-6000 is made possible by use of the Otis Magnetic Tool included in the purchase of the device. The OI-6000 display screen will always show the present concentration of gas being detected by the sensor assembly. These OI-6000 also feature an integrated piezo alarm and LED lighting system. The piezo alarm is configurable to activate on LOW alarm, HIGH alarm, FAULT conditions, or be entirely disabled. The “L” model LED lighting can be configured with a choice of 4 different colors of lighting per each alarm level and fault condition, or all colors the same for every condition. The “GL” model features GREEN LED lighting only, with different flash rates per alarm level and fault condition.

This document is an operation manual containing diagrams and step-by-step instructions for the proper and safe installation, start-up, configuration and settings, normal operation, and product maintenance of the OI-6000.

In this manual, the instructions reference the use of push-buttons, located on the front panel of the device. In certain environments, the activation of the non-intrusive magnetic switches, through the use of the Otis Magnetic Tool, will replace the directive of the button-press actions. To apply the Otis Magnetic Tool, hold the tool to the side of the device enclosure adjacent to the push-button that you wish to activate. When the magnetic switch is toggled, an on-screen indicator will appear on the display screen, signifying that a connection was made.



NOTICE

This document should be read in its entirety before the initial operation of the product.

Should a question arise during the use of the product, this document will serve as a first reference for the end-user. For inquiries beyond the information and instructions provided within this manual, contact the sales representative of this product for assistance.

1.2 PRODUCT SPECIFICATIONS

System Specifications	
Operating Voltage	+12 to +35 VDC
Current Draw	300 mA Maximum
Operating Temperature Range	-20°C to +54°C
Humidity Range	0% to 98% Relative Humidity, Noncondensing
Measurement Range	Varies based on gas type
Response Time	Varies based on gas type
Protection	Power Electromagnetic Interference (EMI) Filter 4-20 mA Surge Suppression RS-485 Modbus Surge Suppression
Display	Transflective (sunlight-readable) 102x64 LCD Screen LED Back-Light
Interface	3 Push-Buttons (MENU, ADD, SUB) 3 Magnetic Switches for Non-Intrusive Calibration LOW and HIGH Alarm Indicator LEDs

Outputs	
Wired (Analog)	4-20 mA (3-Wire)
Wired (Digital)	RS-485 Modbus RTU
WireFree (Optional)	GEN II 900 MHz or GEN II 2.4 GHz
Integrated LED Lighting System	L - Configurable for different colors per alarm and fault condition GL – Green LEDs with different flash rates per alarm and fault condition
Piezo Buzzer	98 dB at 30 cm

Mechanical Specifications	
Enclosure Materials	Polycarbonate Device Enclosure with Clear Lid
Sensor Housing Materials	Black Polypropylene Plastic with Stainless Steel Mesh Screen
Product Dimensions	6.56" T x 6.44" W x 4.98" D
Product Weight	5 lbs.

1.3 SYSTEM DIAGRAMS

Refer to the following diagrams for identification of the external and internal system components that may be referred to in this manual.

1.3.1 EXTERNAL SYSTEM DIAGRAM

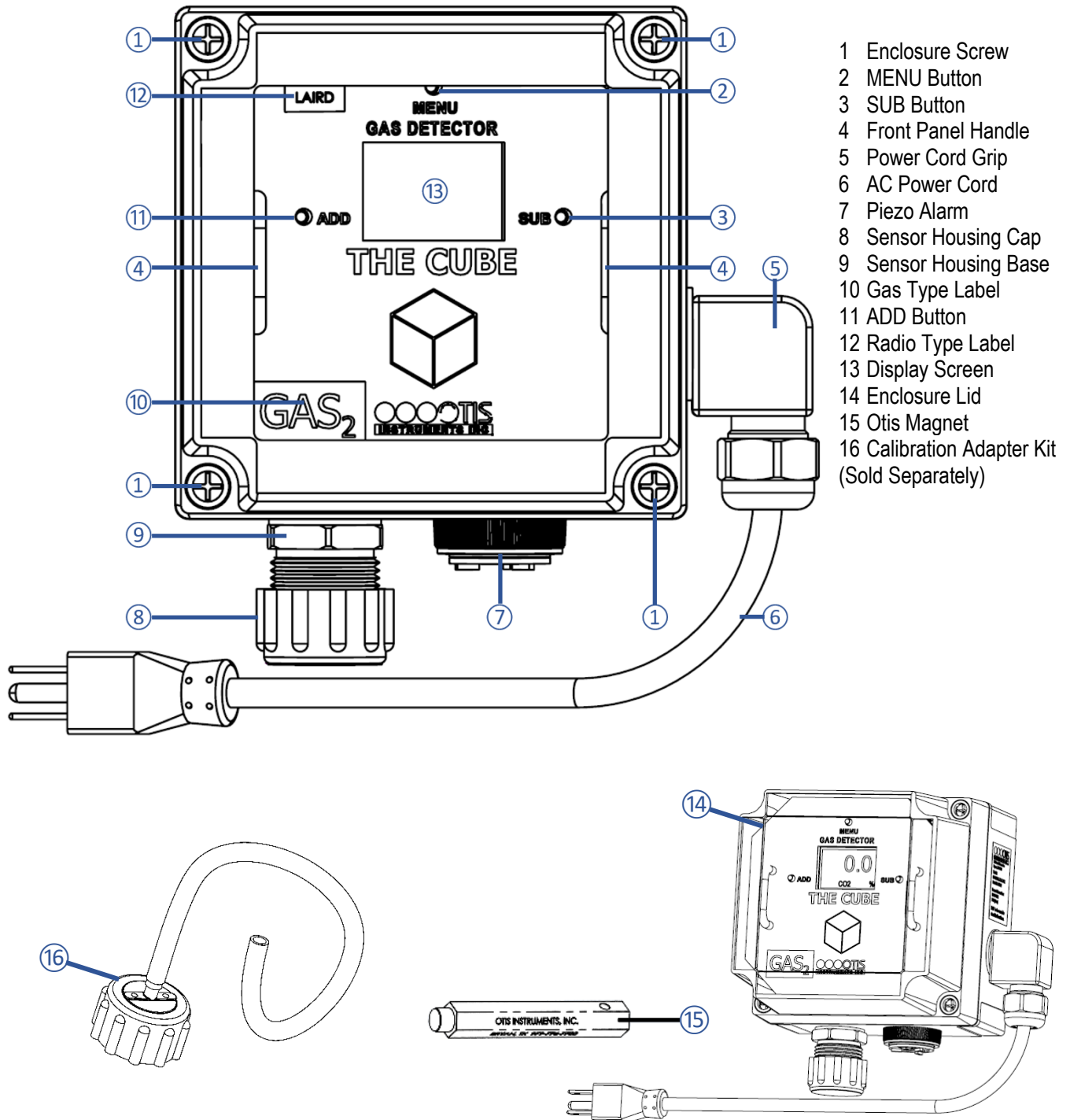

1.3.2 INTERNAL SYSTEM DIAGRAM

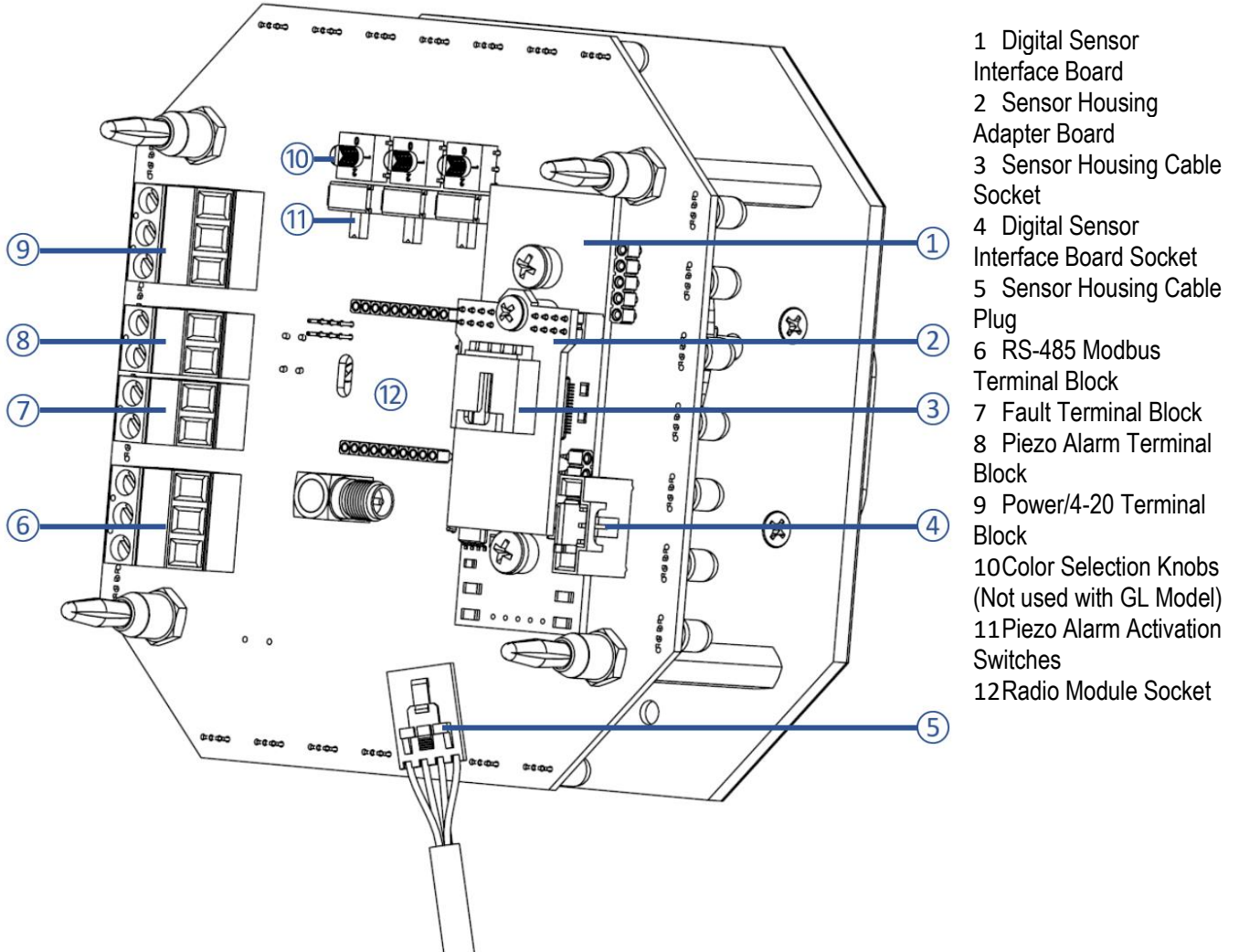

- 1 Digital Sensor Interface Board
- 2 Sensor Housing Adapter Board
- 3 Sensor Housing Cable Socket
- 4 Digital Sensor Interface Board Socket
- 5 Sensor Housing Cable Plug
- 6 RS-485 Modbus Terminal Block
- 7 Fault Terminal Block
- 8 Piezo Alarm Terminal Block
- 9 Power/4-20 Terminal Block
- 10 Color Selection Knobs (Not used with GL Model)
- 11 Piezo Alarm Activation Switches
- 12 Radio Module Socket

1.3.3 ASSEMBLY DIAGRAM

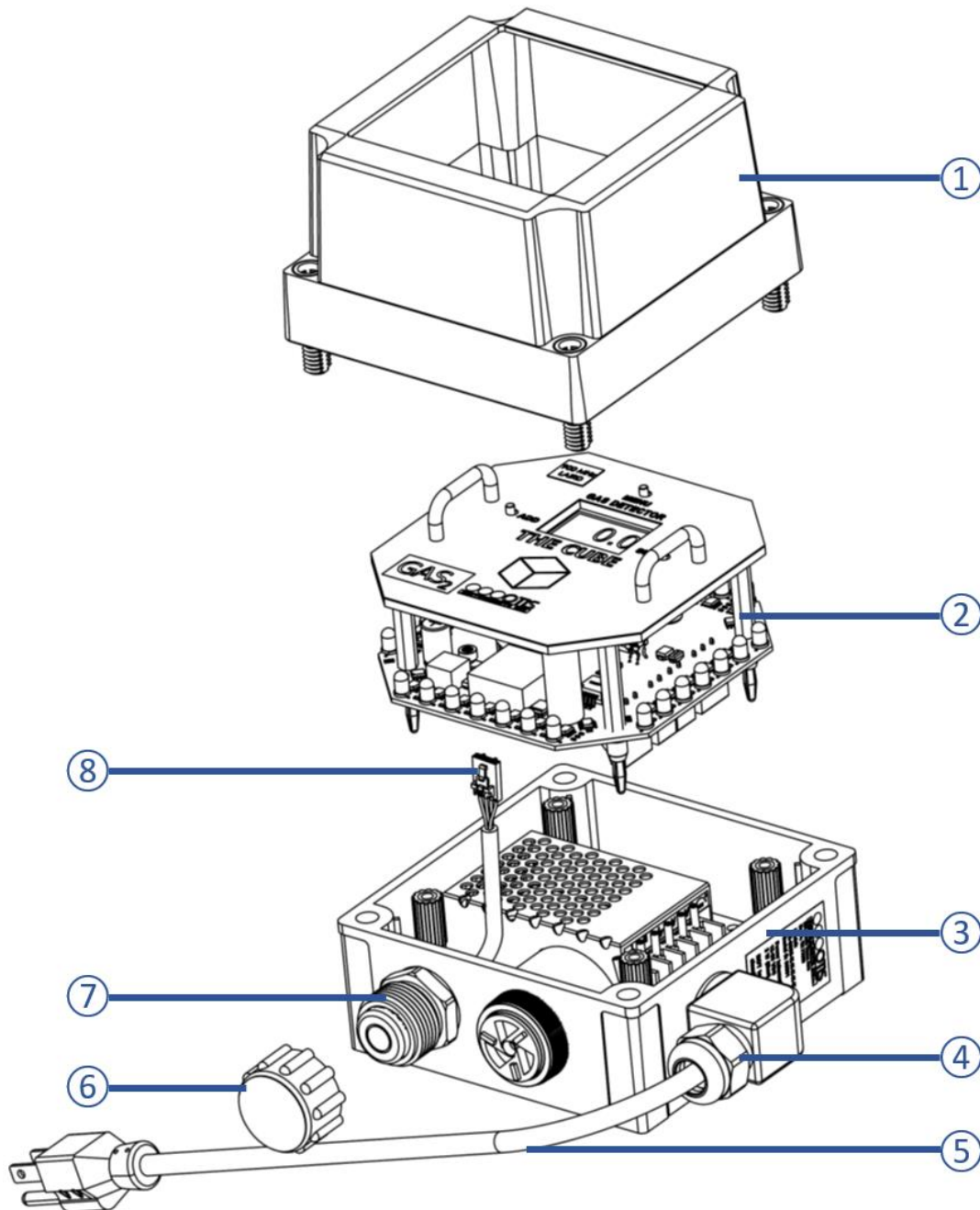

- 1 Enclosure Lid
- 2 Internal System
- 3 Enclosure Base
- 4 Power Cord Grip
- 5 AC Power Cord (If equipped with an AC Power Supply)
- 6 Sensor Housing Cap
- 7 Sensor Housing Base with Element
- 8 Sensor Housing Plug

2 INSTALLATION AND START-UP

2.1 PRODUCT PLACEMENT

The installation instructions, and any other information supplied by Otis, provide only basic guidelines relating to the properties of toxic gas and the effects of environmental conditions on the OI-6000 device. Sensor placement should be determined in consultation with the site safety personnel, as well as those knowledgeable of: (1) the site/facility where the equipment is being installed and (2) the potentially present gas types and their dispersion. Otis strongly recommends that the end-user consults with the appropriate third party Health, Safety and Environmental (HSE) and Industrial Hygiene (IH) professionals to determine the final quantity and placement of your gas detection devices.

The primary purpose of the OI-6000 is to provide an early warning of the accumulation of toxic gas, in order to minimize hazards to people and property. Proper placement of the device is paramount to achieving this goal.

The following general guidelines should be considered when determining the placement of the OI-6000:

- Units with a radio installed should be placed greater than 6.5 Feet/2 Meters away from a monitor in order to ensure reliable communications
- The unit shall be placed such that the position of the sensor housing is pointing downward to the ground.
- Avoid installing the unit in a location where airborne particles could cover or coat the sensor head.
- The unit should be placed in an area that will produce the highest gas concentration. Enclosed corners and stopping points of moving devices are two areas susceptible to a buildup of toxic gas.
- In order to provide an accurate representative sample of a room, care should be taken to avoid locating the unit near a room entrance, fresh air intake vent, or vehicle/generator exhaust point.
- The unit should be placed as close as physically possible to the source of the potential toxic gas leak.
- In consideration of possible ignition points, the unit should be placed between the potential leak source and ignition point.
- Consider placing the unit in a seldom used area, such as a warehouse, storage area, or other unfrequented location.
- Consider accessibility for regular calibration and other required maintenance.
- When monitoring a ventilated gas cylinder storage area, the unit should be placed near the air return vent.
- When monitoring an outdoor or open-air area, the unit should be placed near the air intake of the HVAC system of the building.
- When monitoring for the potential presence of multiple toxic gas types, the unit should be calibrated for the least cross-sensitive toxic gas.



NOTICE

These guidelines are **ONLY** intended as a general directive for the placement of the OI-6000. This information should **NOT** serve as a complete list when considering all potential parameters for the proper location of the unit. It is **STRONGLY** advised that a third party Certified Industrial Hygienist, or other Certified Safety Professional, conduct a site survey and annotate the location and quantity of detection devices that should be installed for **EVERY** installation of **EVERY** site.

2.2 PRODUCT MOUNTING

It is recommended to mount the unit to a solid structure (such as a concrete wall, steel column, or angle iron) where a minimum of vibration will be transmitted to the unit. Alternately, a pole may be used along with a strap or a U-bolt, as long as it is rigid and of sufficient strength. Wooden structures are not recommended for mounting, as they trap moisture (which could affect sensor performance) and their mounting rigidity degrades over time (screws/bolts weaken and fall out or corrode).

Any style of bolt or screw may be used as long as it is steel and meets or exceeds the following:

- Maximum #8 screw (length varies with user need)
- Flat washers for bolts/nuts/screws
- Minimum Grade 5 (or better)
- Corrosion protection for all hardware (paint, galvanize, zinc plating, etc.)

2.3 WIRING CONFIGURATIONS

The OI-6000 has several basic wiring configurations, dependent upon the desired usage and functionality intended by the end-user. All OI-6000 units require +12 to +35 Volts of wired DC power to operate. Data communication from the device, through either the 4-20 output or the RS-485 Modbus connection, to an external location are optional. Consult the subsequent sections of wiring instructions for pertinent information and guidelines pertaining to the installation of your device.



CAUTION

- ◆ **VERIFY** that the power source is disabled before beginning the following wiring steps or performing any maintenance inside the device enclosure.
- ◆ The internal components can be static sensitive. Use caution when opening the enclosure and handling internal components.
- ◆ **DO NOT** use any metal objects or tools to remove the terminal board from the internal system.
- ◆ **VERIFY** that the label and color combination of the control board terminal exactly matches the corresponding label and color combination of the power terminal.



WARNING

- ◆ When securing the lid onto the device, tighten the enclosure lid screws by hand **ONLY**. Overtightening of the lid by use of hand-tools could result in damage to the O-ring, potentially compromising the moisture seal, resulting in an unsafe environment.

OI-6000 Terminal Block Wire Gauges

Terminal Block	Wire Gauge
Power/4-20 Terminal	
Piezo Terminal	Min: 26 AWG
Fault Terminal	Max: 14 AWG
Modbus Terminal	

AWG: American Wire Gauge

2.3.1 OPENING THE ENCLOSURE

If the OI-6000 you are installing has the AC power supply simply plug the supplied cord into a standard wall outlet. If you have the DC model perform the following steps to supply power to the OI-6000.

To prepare the OI-6000 for installation, you must first open the device, exposing the control board and its components for wiring.

1. Remove the enclosure lid, unscrewing the captive screws from the device enclosure base. Set aside.
2. Gripping the front panel handles, lift the internal system out of the enclosure and rest it against the rim of the enclosure opening.
3. Locate the power cord grip on the right edge of the enclosure.



NOTICE

Disconnecting the sensor connector plug from the sensor housing will allow for the complete removal of the internal system from the device enclosure. Disconnecting the internal system may provide ease in accessing the control board terminals for wiring. If this step is performed, it is essential that all connections are rejoined before returning the internal system back into the enclosure.

2.3.2 CONNECTING POWER

To provide power to the OI-6000, you will need to connect the power cable from the sensor terminal block on an Otis monitor, or alternate user supplied power source, to the OI-6000 power terminal block located on the back of the control board. Refer to the following instructions for how to wire your device:

On the GEN II Model OI-6000 Detector:

1. Feed the power wires through the power cord grip and into the enclosure.
2. Locate the power terminal block on the control board and complete the following:
 - a. Connect the power (WHITE) wire to the "+12 to +35 VDC" terminal.
 - b. Connect the ground (BLACK) wire to the "GND" terminal.

On the Otis Monitor:

1. Open the enclosure lid.
2. Using your thumb and forefinger, loosen the front panel thumbscrews that secure the internal system into the enclosure.
3. Open the internal system, exposing the internal hardware.

4. Feed the power wires through a cord grip and into the enclosure.
5. Locate the sensor terminal block on the control board and complete the following:
 - a. Connect the power (WHITE) wire to the “+12 to +35 VDC” terminal.
 - b. Connect the ground (BLACK) wire to the “GND” terminal.

OTIS MONITOR SENSOR TERMINALS		OI-6000 POWER TERMINALS	
+12 to +35 VDC	WHITE	+12 to +35 VDC	WHITE
GND	BLACK	GND	BLACK
4-20 mA		4-20 mA	

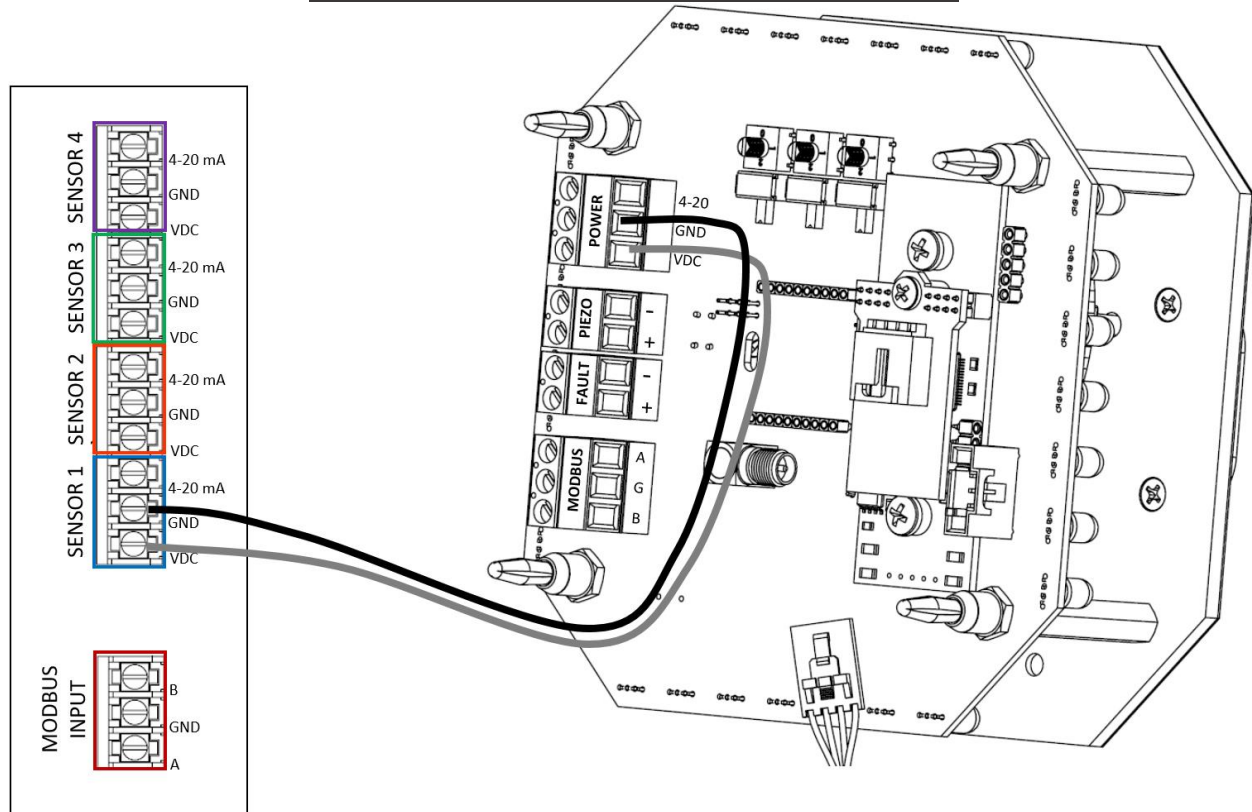

NOTICE

Wiring power to the device is the **ONLY** requirement for the OI-6000 to operate. With the provision of power, the unit will function normally, indicating the presence of toxic gas at the sensor and providing the gas level reading on the display screen. To utilize the added functionality of the device, additional wiring is necessary. If an Otis Monitor is not used, the OI-6000 can be powered from any +12 to +35 VDC power supply that is capable of supplying at least 250 mA.

2.3.3 CONNECTING 4-20 mA OUTPUT

To utilize the 4-20 mA wired data output feature of the OI-6000, you will need to connect the signal cable from your Otis Monitor sensor terminal block to the OI-6000 power terminal block located on the control board. Refer to the following instructions for how to wire your device:

On the GEN II Model OI-6000 Detector:

1. Feed the signal wire through the power hub and into the enclosure.



NOTICE

The power and signal wires may be conjoined as a 3-wire cable, incorporating the power (WHITE), ground (BLACK), and signal (GREEN) wires all into one jacketed cable.

2. Locate the power terminal block on the control board and complete the following:
 - a. Connect the signal (GREEN) wire to the “4-20 mA” terminal.

On the Otis Monitor:

1. Feed the signal wire through the power hub and into the enclosure.
2. Locate the sensor terminal block on the control board and complete the following:
 - a. Connect the signal (GREEN) wire to the “4-20 mA” terminal.

OTIS MONITOR SENSOR TERMINAL		OI-6000 POWER TERMINAL	
+12 to +35 VDC	WHITE	+12 to +35 VDC	WHITE
GND	BLACK	GND	BLACK
4-20 mA	GREEN	4-20 mA	GREEN

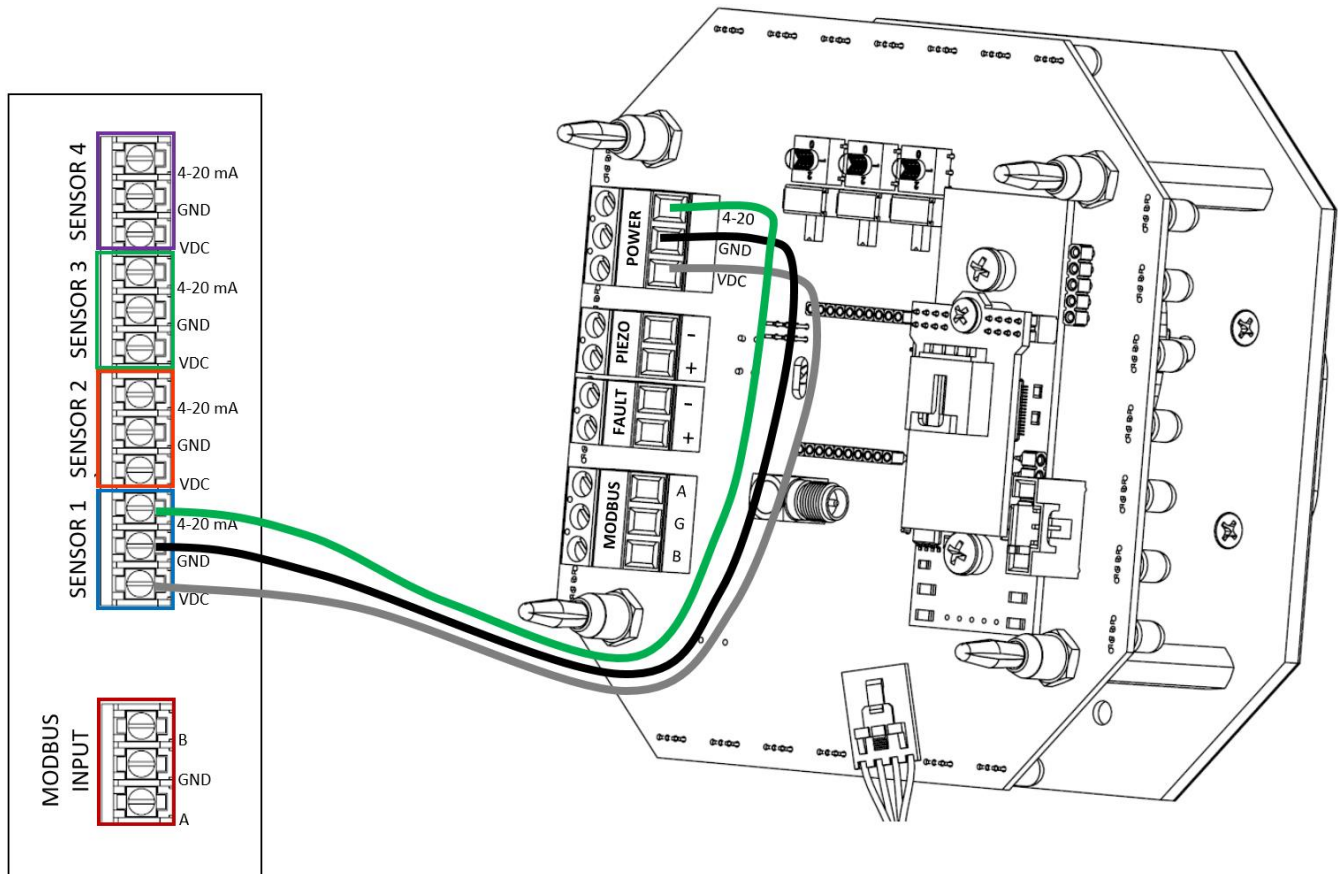

2.3.4 CONNECTING RS-485

The OI-6000 supports Modbus RTU over a RS-485 link. To integrate your device with RS-485 Modbus data communications, you will need to connect the Modbus cable from your Otis Monitor RS-485 input terminal block to the OI-6000 RS-485 output terminal block located on the control board of the unit. Refer to the following instructions for how to wire your device:

On the GEN II Model OI-6000 Detector:

1. Feed the RS-485 cable through the power hub and into the enclosure.
2. Locate the RS-485 output terminal block on the control board and complete the following:
 - a. Connect the RS-485 B (BROWN) wire to the “B” terminal.
 - b. Connect the ground (WHITE) wire to the “GND” terminal.
 - c. Connect the RS-485 A (YELLOW) wire to the “A” terminal.

On the Otis Monitor:

1. Feed the RS-485 cable through the power hub and into the enclosure.
2. Locate the RS-485 input terminal block on the control board and complete the following:
 - a. Connect the RS-485 B (BROWN) wire to the “B” terminal.
 - b. Connect the ground (WHITE) wire to the “GND” terminal.
 - c. Connect the RS-485 A (YELLOW) wire to the “A” terminal.

OTIS MONITOR RS-485 TERMINAL		OI-6000 RS-485 TERMINAL	
A	YELLOW	A	YELLOW
GND	WHITE	GND	WHITE
B	BROWN	B	BROWN

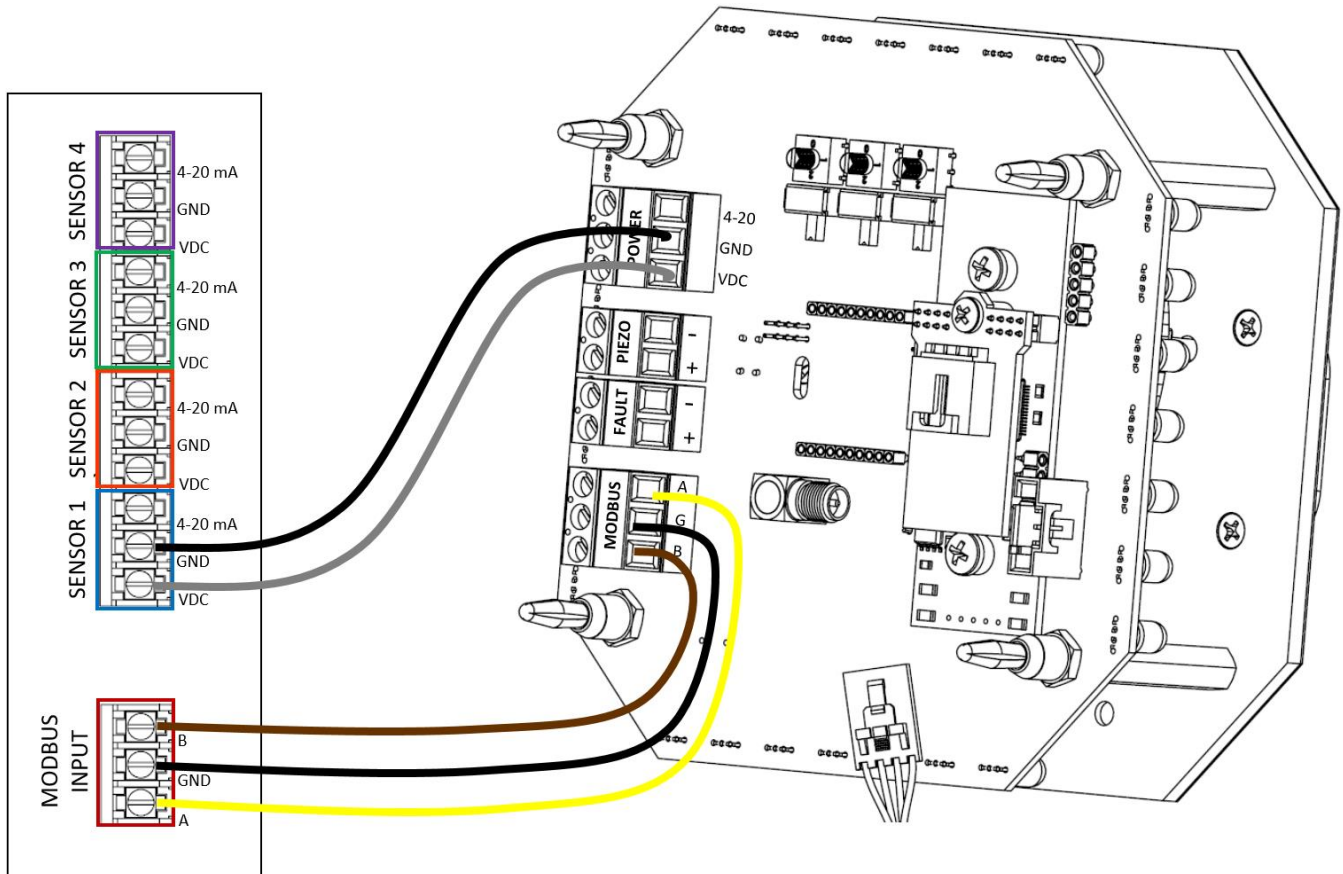

NOTICE

If an Otis Monitor is not used, the OI-6000 can be connected to a Programmable Logic Controller (PLC) for RS-485 Modbus data communications. For integration and setup, refer to the Modbus Register Map found in Appendix C of this manual.

2.3.5 CONNECTING PIEZO ALARM

The OI-6000 comes with the piezo alarm already wired from the factory. The following instructions should be used if the piezo needs to be replaced due to damage in the field.



NOTICE

The piezo alarm output can alternately be used as a wet contact relay output. The maximum current that can be drawn from the piezo alarm terminal is 500 mA, the voltage will match the DC voltage supplied to the unit.

On the OI-6000 Detector:

1. The new piezo alarm is shipped with wires attached from the factory. Locate the piezo terminal block on the control board and complete the following:
 - a. Connect the power (RED) wire to the “+” terminal.
 - b. Connect the ground (BLACK) wire to the “-“terminal.

OI-6000 PIEZO TERMINAL		PIEZO ALARM	
+	RED	+	RED
-	BLACK	-(CONST)	
		-(PULSE)	BLACK

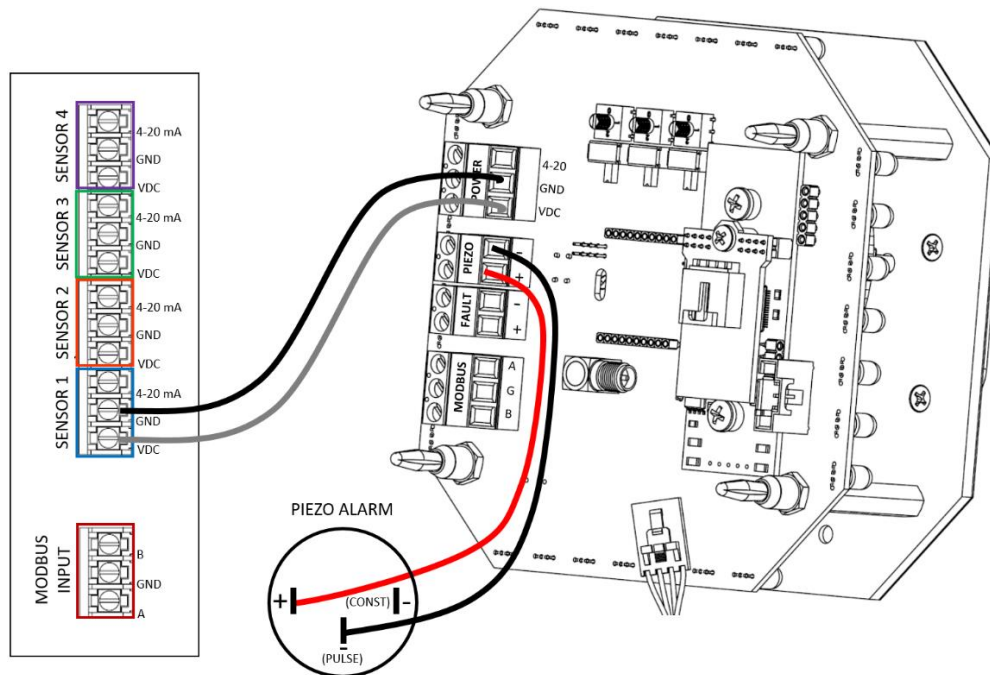

2.3.6 CONNECTING THE FAULT TERMINAL

The fault terminal is used to provide indication of a device failure. The fault terminal is shipped configured as a normally-closed (NC), or fail-safe, configuration, terminating power to the external fault device when prompted, this behavior cannot be changed. The fault terminal is a wet-contact, requiring only the power and ground wires of the external fault device to be wired during installation. Refer to the following instructions for how to wire your device:

On the external fault device (light/horn):

1. Locate the power (RED) and ground (BLACK) wires on the alarming device.

On the GEN II Model OI-6000 Detector:

1. Feed the alarming device wires through the power hub and into the enclosure.
2. Locate the fault terminal block on the control board and complete the following:
 - a. Connect the external fault device power (RED) wire to the “+” terminal.
 - b. Connect the external fault device ground (BLACK) wire to the “-” terminal.

EXTERNAL FAULT DEVICE		OI-6000 FAULT TERMINAL	
PWR	RED	+	RED
GND	BLACK	-	BLACK

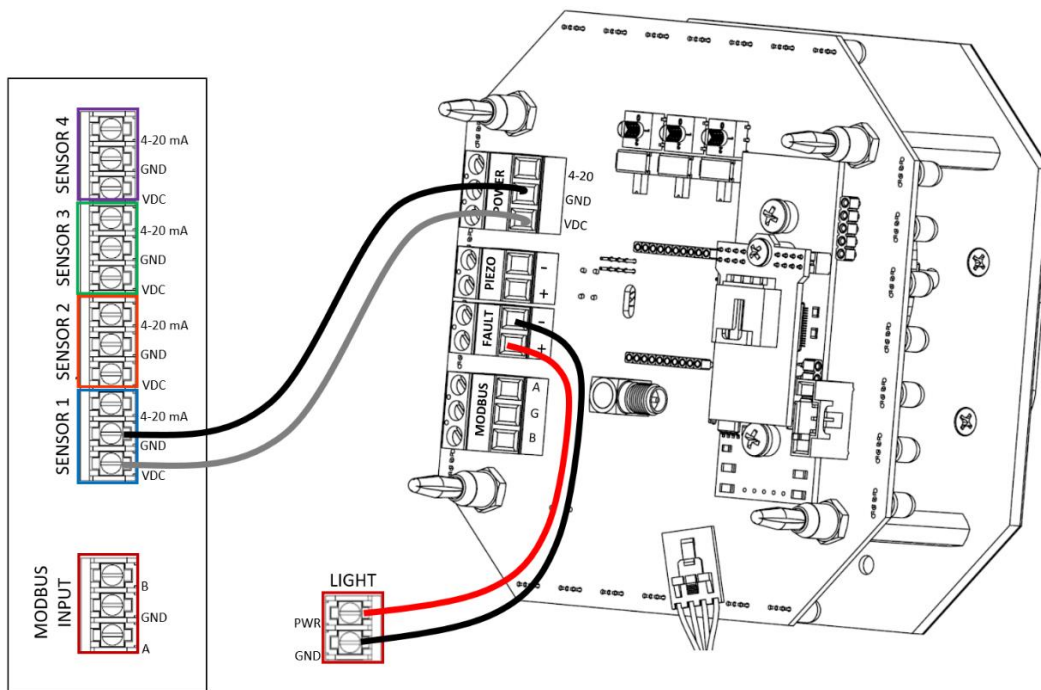

2.3.7 CONFIGURING THE LIGHT COLORS AND PIEZO ALARM ACTIVATION

The integrated LED light ring and piezo alarm allow this OI-6000 to be a fully contained sensor assembly with alarms. On the “L” model the color of the LEDs for each Alarm and Fault event are configurable from 1 of 4 color choices, the “GL” model only has green LEDs with a different flash rate per alarm and fault condition. The piezo alarm is configurable to activate for each of the alarm and fault conditions, all of the alarm and fault conditions, or none of the alarm and fault conditions. From the factory the light colors and piezo alarm activation come configured for the following values on the “L” model:

- Alarm 1 – Amber, no Piezo Alarm
- Alarm 2 – Red, Piezo Alarm
- Fault – White, no Piezo Alarm

To configure the alarm or fault colors and piezo alarm operation differently please refer to the following instructions.

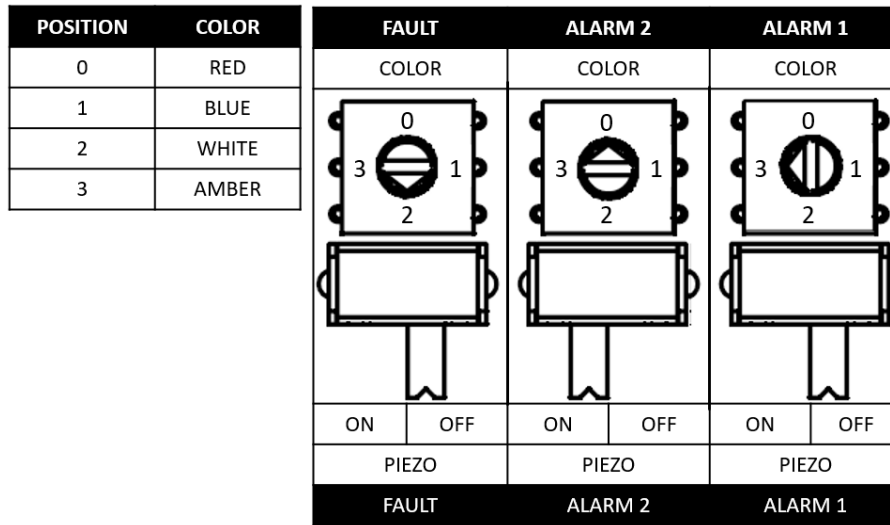

Each twist knob has a triangle shape that points to one of four positions, each number corresponds to the color detailed in the chart to the left of the knobs. The slide switches below the twist knobs allow for having the piezo alarm activate or not for each alarm and fault condition when they occur and have a choice of ON and OFF. ON means that the piezo will be active when that specific condition occurs, OFF means the piezo will not activate when that condition occurs.



NOTICE

The alarm set points, and whether the alarm activate on a rising or falling gas level, are detailed further in this manual. These knobs and switches only affect the color of the lighting and if the piezo is active when those conditions occur.

2.3.8 CLOSING THE ENCLOSURE

1. Place the internal system back into the device enclosure, matching each mounting post to its corresponding eyelet anchored within the base of the enclosure.
2. Using the front panel handles, gently push to seat the internal system into the mounting posts.



NOTICE

The front panel handles on the OI-6000 function **ONLY** as thumb-holds for ease in removal of the internal system from the base of the enclosure.

3. Verify that the sealing ring, seated at the opening of the device enclosure, is correctly in place.
4. Affix the enclosure lid back onto the device, tightly screwing the captive screws into the enclosure base.

2.4 SYSTEM START-UP

After the enclosure is closed and power is applied, the unit will start automatically and begin its 1-minute warmup period. During warmup, the display will show a countdown of the time remaining until the system start-up is complete. The Otis logo and the unit information will also show on the display screen during start-up.

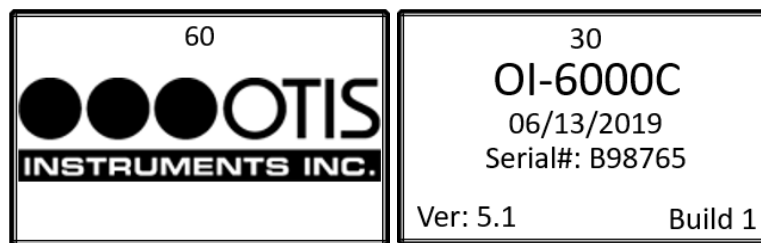

At the end of the countdown, the device will be in normal operating mode.

2.5 NORMAL OPERATING MODE

During normal operating mode, the OI-6000 continuously samples the air and updates the measured concentration of the target gas on the display screen. The display, when in normal operation, appears as shown below.

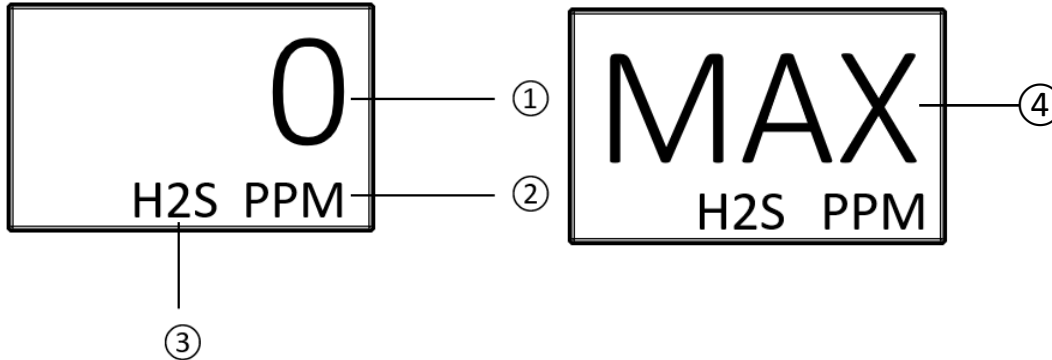

- 1 Measured gas concentration (reading)
- 2 Gas concentration unit of measure
- 3 Sensor element gas type
- 4 Readings above full scale show as **MAX** and the 4-20 output is set to 25 mA

In the event of a device failure, the unit will alternate between the normal operating screen and a fault screen on the display, in 5 second intervals, until the fault has been cleared, or is corrected. The fault code, located in the bottom-left corner of the display, appears on both screens. The unit continuously registers that the system is in fault, so that even with at-a-glance instrument checks in the field, it can be seen. When the fault is corrected, the unit will return to normal operating mode.

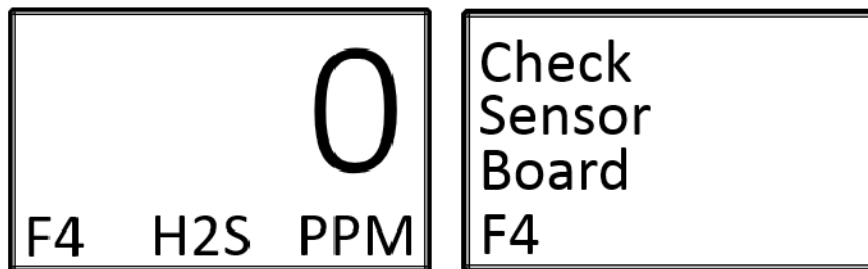

For a list of the fault codes and warning symbols of the OI-6000, and their associated meaning, refer to the Product Troubleshooting section of this manual.

Both system menus are accessible from the normal operating mode. To access the product settings and configuration menu, **press and hold** the **MENU** button, for approximately 6 seconds, until the menu is activated and open on the display screen. To access the operation settings menu from the normal operating screen, press the **MENU** button once and the menu will open and show on the display.



NOTICE

After 5 minutes of no interaction with the device, the unit will automatically return to normal operating mode.

3 PRODUCT SETTINGS AND CONFIGURATION

The product settings and configuration menu allows the end-user to tailor the device settings to meet their required specifications and/or site conditions.

The product settings and configuration menu consist of the following screens:

- Alarm Test
- Network ID
- System Information
- Null/Calibration Timers
- Unit Info
- Background Setting
- Alarm 1: Latching/Non-Latching Setting
- Alarm 2: Latching/Non-Latching Setting
- Calibration Method
- RS-485 Modbus Address Setting
- RS-485 Modbus Baud Setting
- 4-20 mA Offset Settings
 - Zero Offset Setting
 - Full-Scale Offset Setting
- Display Screen Contrast Setting
- Return to Factory Default Settings
- Reset Null and Calibration Values Only

While the device is in normal operating mode, **press and hold** the **MENU** button, for approximately 6 seconds, until the product settings and configuration menu is activated and open on the display screen.

3.1 ALARM TEST

The alarm test simulates a gas level reading, indicating the presence of a toxic gas at the sensor. The alarm test is used to ensure the proper functionality of the relay settings on the Otis monitor. The test can also be used to simulate emergency/safety drills onsite.



NOTICE

The triggering of alarms from the detector will also simulate low and high level alarm relays at the monitor. Monitors cannot distinguish between real and simulated data received. When the monitor relays are triggered, alarming devices will perform as intended, initiating emergency procedures as if a harmful or toxic gas was actually present. To prevent this from occurring, set the monitor to calibration mode before performing the relay test. Calibration mode of the monitor will allow the transmission of the data, without the activation of the monitor relays. Consult the Sensor Calibration section of this manual for instructions on how to perform this procedure.

It is recommended that an alarm test be conducted **EVERY** 30 days, alongside the maintenance and calibration of the detector.

3.1.1 PERFORMING THE ALARM TEST

The alarm test gas level reading can be increased or decreased in increments of 5% of the sensor scale, up to 100% of the sensor scale.

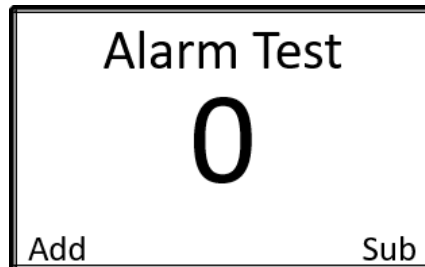

1. Press the **ADD** button until the low and high alarm levels are reached and the monitor relay(s) are triggered to light all visual alarm(s) and sound all audio alarm(s).
2. Once all monitor relays have been tested and the test is complete, press the **SUB** button to return the relay test reading back to zero and to deactivate the monitor alarm(s).
3. Press the **MENU** button to advance to the System Information screen.

3.2 NETWORK ID

The Network ID is used to synchronize the communication between the Otis Monitor and Sensor Assembly:

- There are 52 networks available with the GEN II 900 MHz radio.
- There are 78 networks available with the GEN II 2.4 GHz radio.
- The monitor and sensor assembly must have the same Network ID in order to communicate.

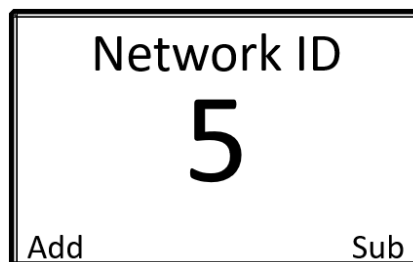

1. Press the **ADD** or **SUB** button until the Network ID matches the value being used on the Primary Monitor.
2. Press the **MENU** button to advance to the System Information screen.



NOTICE

This page will not appear if no radio module is installed. Please skip to section 3.3 SYSTEM INFORMATION.

3.3 SYSTEM INFORMATION

The system information screen allows the end-user to view the following information:

- The status of the radio link (Only present if radio module is installed)
- The scale of the sensor element.
- The supply voltage of the sensor unit.
- The voltage value the sensor was reading when nulled in Volts.
- The current voltage value the sensor element is reading in Volts.

This screen is for informational purposes only.

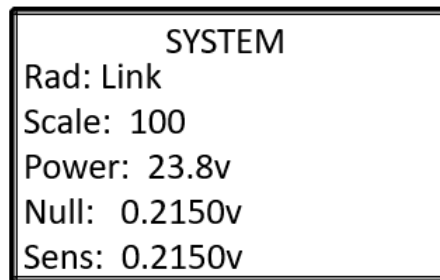

1. Press the **MENU** button to advance to the Null/Calibration Time Information screen.

3.4 NULL/CALIBRATION TIMER INFORMATION

The null/calibration time information screen allows the end-user to view the following information:

- The days since the sensor assembly was last nulled, only updates while the unit is turned on.
- The days since the sensor assembly was last calibrated, only updates while the unit is turned on.
- The calibration number of the sensor, used for diagnostic purposes.

This screen is for informational purposes only.

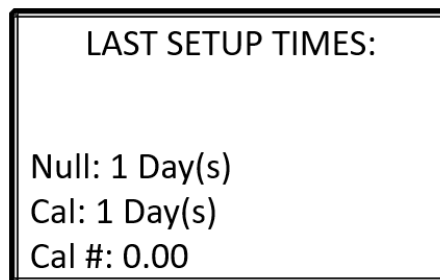

1. Press the **MENU** button to advance to the Unit Information screen.

3.5 UNIT INFORMATION

The unit information screen allows the end-user to view the following information:

- The number of missed radio transmissions to the monitor (Only present if radio module installed)
- The date of manufacture of the sensor assembly.
- The serial number of the sensor assembly.

This screen is for informational purposes only.

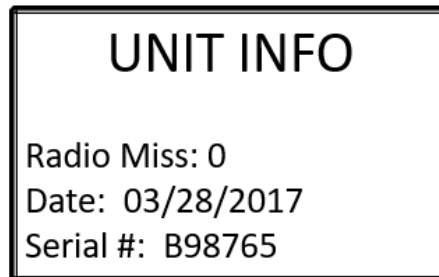

1. Press the **MENU** button to advance to the Background setting screen.

3.6 BACKGROUND SETTING

The background setting is the gas reading at which the radio transmission changes from once every minute to once every five seconds. The background setting is adjustable so that if there is a consistent level of gas always present the sensor will not increase the radio transmission rate.

- The default background level is 4% of the sensor element scale.
- The minimum that the background can be set to is 1% of the sensor element scale.
- The maximum that the background can be set to is 100% of the sensor element scale.

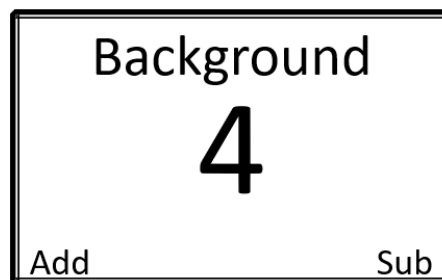

1. Press the **ADD** or **SUB** button until the Background is set to the desired level.
2. Press the **MENU** button to advance to the Alarm 1 latching/non-latching setting screen.

3.7 LATCHING AND NON-LATCHING ALARM SETTINGS

Alarm 1 and Alarm 2 can be set to latching or non-latching. Alarms set to non-latching will automatically deactivate when the detected gas level falls below the corresponding alarm setting. Conversely, latching alarms, once activated, **MUST** be manually reset at the device, regardless of the change in gas detection level readings.

The factory default settings on the OI-6000 for Alarm 1 and Alarm 2 are non-latching. During installation and setup, Alarm 1 and Alarm 2 are commonly customized as the following:

Common Alarm 1 and Alarm 2 Settings		
Relay	Alarm Setting	Latching/Non-Latching
Alarm 1	Low	Non-Latching
Relay 2	High	Latching

3.7.1 ALARM 1: LATCHING/NON-LATCHING SETTING

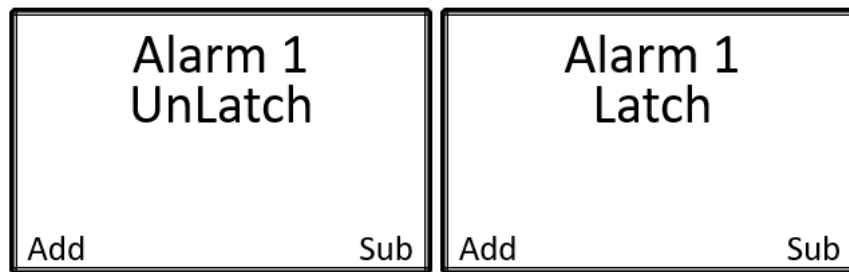

1. Use the **ADD** and **SUB** buttons to toggle between the “UnLatch” and “Latch” options.
2. Press the **MENU** button to select the desired setting and to advance to the Alarm 2 latching/non-latching setting screen.



NOTICE

- ◆ For non-latching alarms, the alarms will **NOT** deactivate until the gas level reading at the sensor has fallen 10% below the alarm set-point.
- ◆ For latching alarms, the gas level reading **MUST** be below the alarm set-point before the alarm can be deactivated.

3.7.2 ALARM 2: LATCHING/NON-LATCHING SETTING

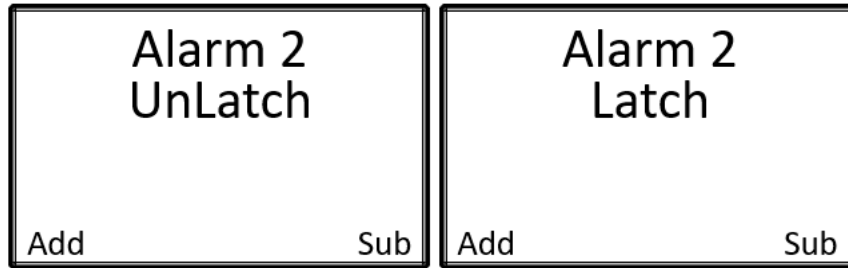

1. Use the **ADD** and **SUB** buttons to toggle between the “UnLatch” and “Latch” options.
2. Press the **MENU** button to select the desired setting and to advance to the calibration method setting screen.

3.8 CALIBRATION METHOD

The calibration method selection allows you to choose how you calibrate the sensor element. Manual calibration is the default method for all gas types.

- Manual calibration lets you use the **ADD** and **SUB** buttons during calibration to match the reading shown on the screen to the value of the gas being applied.
- Auto calibration will set the reading, after a predetermined amount of time, during calibration to the value entered during the auto calibration setup process.

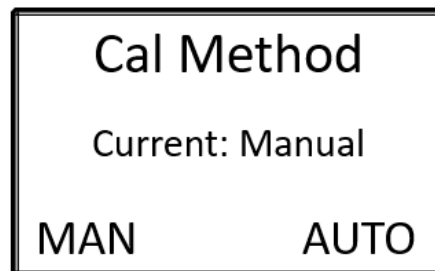

1. Use the **ADD** button to select manual calibration and the **SUB** button to select auto calibration.
2. Press the **MENU** button to advance to the Modbus Address Setting screen.

3.9 MODBUS ADDRESS SETTING

Modbus is the leading industrial open control protocol. Modbus is available in several different types, depending upon the media over which it is transmitted. Like most communication protocols, Modbus uses a master/client type behavior. The master sends a poll request for information to the client, the client decodes the request, and then sends a response with the requested data back to the master.

A Modbus message includes a Modbus address, commonly referred to as a unit ID. The Modbus address is used to identify the server address in RS-485 networks. Each server is assigned an address and listens for messages which contain this number in the Modbus address field.

The OI-6000 uses the original Modbus RTU over the RS-485 link. RS-485 Modbus has 255 addresses, ranging from 1 to 255. Eight of the addresses are used for internal system settings, leaving addresses 1 to 247 available for your device.

The RS-485 Modbus communication parameters used in Otis devices is 8 data bits, no parity, and 1 stop bit; these parameters are fixed and cannot be changed. The floating point data values are presented with the least significant bytes first.

When using Modbus over a RS-485 network, the communication parameters **MUST** be set correctly for all devices. For multiple devices using Modbus, ensure that no two units are assigned the same address. A duplication of addresses could cause errors in the transmission of data. Modbus addresses can be assigned sequentially or another appropriate address scheme for the specific network setup.

The factory default setting on the OI-6000 for the Modbus address setting is 1.

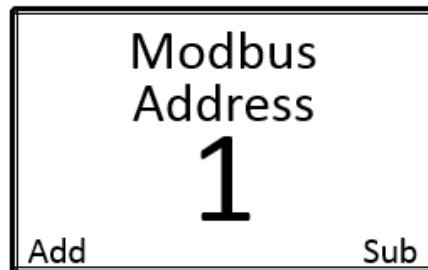

1. Use the **ADD** and **SUB** buttons to increase and decrease the Modbus address number, respectively.
2. Press the **MENU** button to select the desired setting and to advance to the Modbus baud setting screen.

3.10 MODBUS BAUD SETTING

The baud rate is the speed of data transmitted within the Modbus system, measured in bits per second (bps). For successful communication, the baud rate setting of the OI-6000 **MUST** match the baud rate setting on the attached Otis Monitor, or other Modbus device.

All Otis devices have factory default Modbus baud settings of 9600 bps. The RS-485 Modbus communication parameters used in all Otis devices are 8 data bits, no parity bit, and 1 stop bit (8-N-1) these parameters are fixed and cannot be changed. Some devices come with different Modbus baud rates. Check with your system administrator to determine if a different Modbus baud setting is needed for your system.

The pre-set Modbus baud setting available for the OI-6000 are the following:

- 110 bps
- 300 bps
- 1200 bps
- 2400 bps
- 4800 bps
- 9600 bps
- 19200 bps

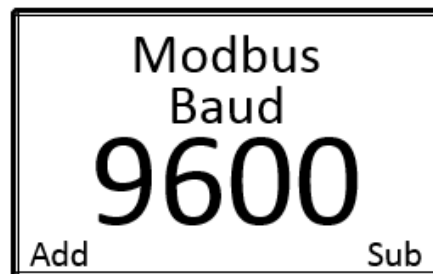

1. Use the **ADD** and **SUB** buttons to scroll through the available Modbus baud options.
2. Press the **MENU** button to select the desired setting and to advance to the 4-20 mA offset settings screen.

3.11 4-20 mA OFFSET SETTINGS

Setting the 4-20 mA offset allows the end-user to calibrate the sensor's analog output. Upon installation of the device, if the detected gas reading on OI-6000 does not correspond to the reading on the Otis Monitor, or other monitoring device, the zero offset (4 mA) and the full-scale offset (20 mA) can be adjusted on the unit.

Overtime, as electronic components suffer from normal wear and tear, the circuits will tend to drift. This drift can cause variances in the amount of current output by the sensor, or in the current measurement by the monitor. If at any time the reading on the OI-6000 no longer matches the reading on the monitoring device, the 4-20 mA offset will need to be recalibrated.

The factory default settings on the OI-6000 for the 4-20 mA offset are 4.00 mA for the zero offset and 20.00 mA for the full-scale offset.

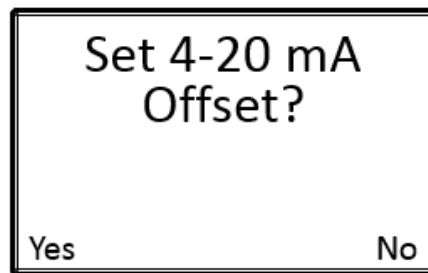

1. Press the **ADD** button to select "Yes" to set the 4-20 mA offset and to advance to the zero offset setting screen. If you do not wish to set the 4-20 mA offset, press the **SUB** button to select "No" to advance to the display screen contrast setting screen.

3.11.1 ZERO OFFSET SETTING

If "Yes" is selected to set the 4-20 mA offset:

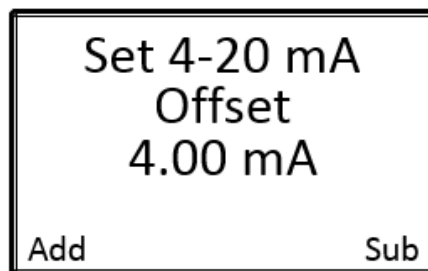

1. Use the **ADD** and **SUB** buttons to increase and decrease the zero offset on the unit, respectively, until the **Otis Monitor** reads 0 %/PPM, depending on the gas type being detected.
2. Press the **MENU** button to save the desired setting and to advance to the full-scale offset setting screen.

3.11.2 FULL-SCALE OFFSET SETTING

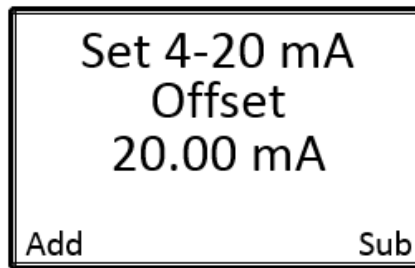

1. Use the **ADD** and **SUB** buttons to increase and decrease the full-scale offset, respectively, until the **Otis Monitor** reads the full scale value for that channel.
2. Press the **MENU** button to save the desired setting and to advance to the display screen contrast setting screen.

3.12 DISPLAY SCREEN CONTRAST SETTING

The display screen contrast is the difference in luminance or color that makes the displayed images distinguishable. Due to varying external elements, such as extreme sunlight, the brightness of the display screen may need to be adjusted for optimum viewing.

The factory default setting on the OI-6000 for the display screen contrast is 29, approximately 45% of the contrast scale. The contrast setting ranges from 1 to 64.



NOTICE

Setting the contrast too low will cause the display image to become faint or indistinguishable, especially when the unit is located in areas with full-sun. The resulting field of view could be misinterpreted as an error within the device. Be sure to verify that the selected contrast is within an appropriate range of viewing.

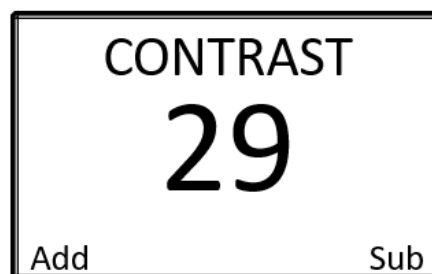

3. Use the **ADD** and **SUB** buttons to brighten and dim the contrast, respectively.
4. Press the **MENU** button to select the desired setting and to advance to the return to factory default settings screen.

3.13 RETURN TO FACTORY DEFAULT SETTINGS

Returning the OI-6000 to its factory default settings will reset all customization of the device, including the null and calibration settings of the sensor element.

OI-6000 Product and Configuration Factory Default Settings	
Configuration	Setting
Relay Test	--
Network ID	5
System Information	--
Null/Calibration Timer	*Cleared*
Unit Information	--
Background Setting	4% of sensor scale
Alarm 1: Latching/Non-Latching	UnLatch
Alarm 2: Latching/Non-Latching	UnLatch
Calibration Method	Manual
RS-485 Modbus Address Setting	1
RS-485 Modbus Baud Setting	9600 bps
4-20 mA Zero Offset Setting	4.00 mA
4-20 mA Full-Scale Offset Setting	20.00 mA
Contrast	--

OI-6000 Operation Factory Default Settings	
Configuration	Setting
Sensor Element Null	*Cleared*
Sensor Element Calibration	*Cleared*
Sensor Assembly Low Alarm Setting	10% of Sensor Scale
Sensor Assembly Low Alarm Rise/Fall Setting	Rise
Sensor Assembly High Alarm Setting	15% of Sensor Scale
Sensor Assembly High Alarm Rise/Fall Setting	Rise

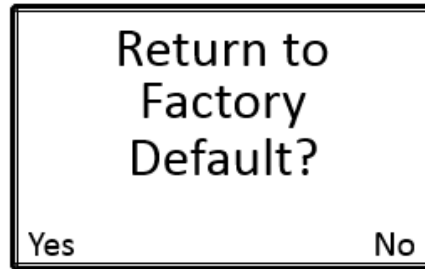

1. Press the **ADD** button to select "Yes" to return the device to its factory default settings and to advance to the return to factory default settings confirmation screen. If you do not wish to return the device to its factory default settings, press the **SUB** button to select "No" to continue to the Reset Null & Cal Only screen.

If "Yes" is selected to return the device to its factory default settings:

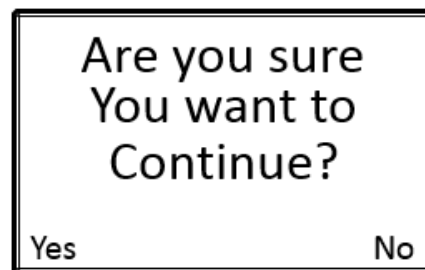

1. Press the **ADD** button to select "Yes" to confirm that you want to reset the device to its factory default settings and to return the device to normal operating mode. If you do not wish to continue to return the device to its factory default settings, press the **SUB** button to select "No" to continue to the Reset Null & Cal Only screen.



NOTICE

If the OI-6000 is reset to the factory default settings, the configuration steps **MUST** be repeated and the device **MUST** then be nulled and calibrated for proper operation of the device.

3.14 RESET NULL & CALIBRATION VALUES

Resetting the null and calibration settings of the sensor element will allow the currently stored null and calibration values to be reset without having to reconfigure all of the other operational settings like with the Return to Factory Defaults option.



1. Press the **ADD** button to select "Yes" to reset the Null and Calibration values and to advance to the Reset Null & Cal Only confirmation screen. If you do not wish to reset the null and calibration values, press the **SUB** button to select "No" to leave the product settings and configuration menu and to return the device to normal operating mode.

If "Yes" is selected to reset the null and calibration values:

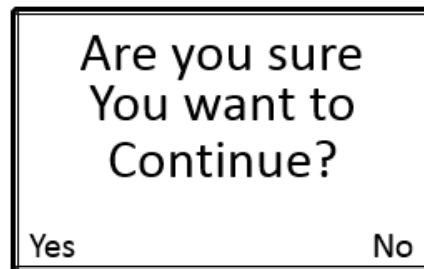

2. Press the **ADD** button to select "Yes" to confirm that you want to reset the Null and Calibration values and to return the device to normal operating mode. If you do not wish to continue to reset the Null and Calibration values, press the **SUB** button to select "No" to leave the product settings and configuration menu and to return the device to normal operating mode.



NOTICE

If the OI-6000 stored Null and Calibration values are reset the device **MUST** be nulled and calibrated for proper and safe operation of the device.

4 OPERATION SETTINGS

At the time of installation, when the power is first applied to the OI-6000, the unit is automatically powered on and begins the startup sequence. During the 1-minute warmup, the display will show a countdown of the time remaining until the system start-up is complete. The Otis logo and the unit information will also flash on the display screen and, at the end of the countdown, the device will be in normal operating mode.

4.1 POWERING THE DEVICE

4.1.1 POWERING OFF

Powering off the device stops the operation of the unit. The product settings and configuration, as well as the operation settings, including the null and calibration of the sensor, will be unaffected.

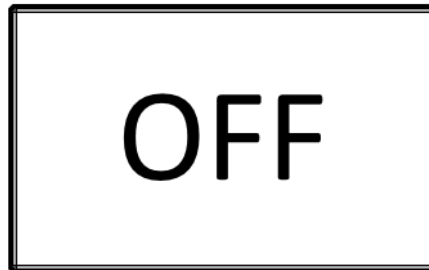

1. **Press and hold** the **SUB** button for approximately 6 seconds, until “OFF” shows on the display screen.

The display screen will continue to show “OFF” for the duration of time that the unit is powered off, as long as long as uninterrupted power is supplied to the unit.

4.1.2 POWERING ON

Powering on the device begins the operation of the unit, automatically initiating the system start-up cycle and 1-minute warmup period. The OI-6000 will be in normal operating mode at the completion of the system start-up.

1. **Press** the **ADD** button once to turn the unit on.

4.2 SENSOR CALIBRATION

Calibration is the process of evaluating and adjusting the precision and accuracy of measurement equipment. Although Otis calibrates every device at the factory, for best accuracy, the detector **SHOULD** be calibrated in the environment where it is installed.

It is imperative that the calibration occur as part of the installation process, and then **EVERY** thirty (30) days thereafter. Days since last calibration should **NEVER** exceed ninety (90) days. Otis recommends that you calibrate your device regularly to ensure proper functionality and a safe work environment.

4.2.1 NULLING THE SENSOR (AUTO NULL)

The first step of calibration is nulling the sensor, sometimes referred to as “setting the zero” or “zeroing the sensor.” The nulling process **MUST** be performed in known clean air, with no contaminants or hazardous gasses present. If air quality cannot be guaranteed, a bottle of zero air will be required to properly null the sensor.



1. While the product is in normal operating mode, press the **MENU** button to activate the operation settings menu.

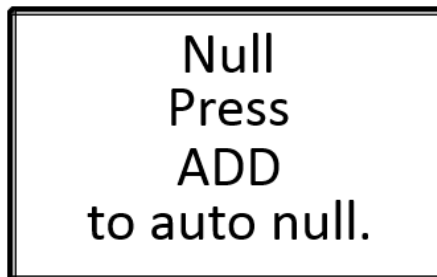

2. Press the **ADD** button to begin the null process and advance to the clean air confirmation screen.

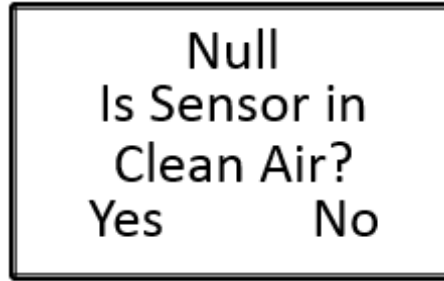

3. Press the **ADD** button to select “Yes” to confirm that the sensor is in clean air and to begin nulling the sensor. If the sensor is not in clean air, press the **SUB** button to select “No” to discontinue the null process and to return to the previous screen.



NOTICE

If “**Yes**” is selected at this point, the null process cannot be stopped without disconnecting the power from the unit.

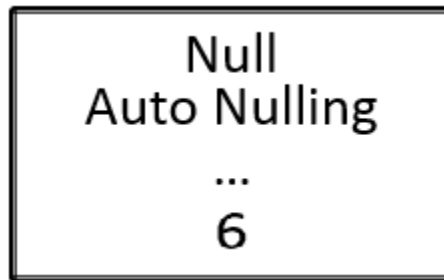

4. The unit will automatically begin the 6-second null process. During null, the display will show a countdown of the time remaining until the process is complete.

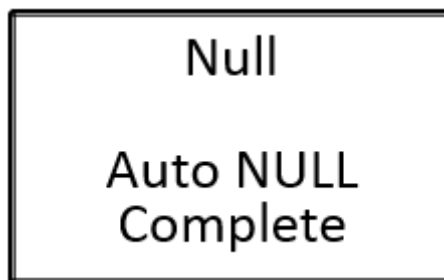

5. When null process is complete, press the **MENU** button to advance to the calibration screen.

4.2.2 CALIBRATING THE SENSOR (MANUAL CAL)

You should **ONLY** perform the calibration of the sensor after the null process has been completed. For best results, use 50% of the sensor scale of your target gas in an air balance with a flow rate of 0.25 to 0.5 LPM. The screen below will appear upon entering calibration mode. If Auto Cal was chosen during the **Product Settings and Configuration** section please skip to section 4.2.3.

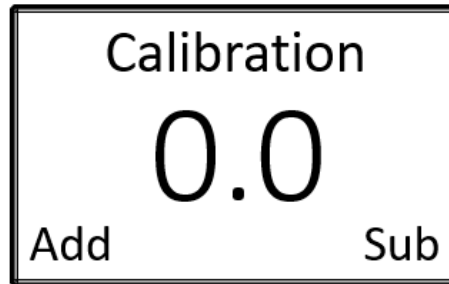

1. Unscrew and remove the sensor housing cap from the assembly.
2. Affix a Calibration Adapter Kit (sold separately) to the sensor housing of the device.
3. Affix a regulator to the calibration gas bottle.
4. Attach the tubing on the Calibration Adapter Kit to the regulator on the calibration gas bottle.
5. Ensure that the gas is flowing and watch the reading increase. When the reading stabilizes, approximately 1 minute, use the **ADD** and **SUB** buttons to adjust the reading on the screen to match the applied calibration gas concentration.

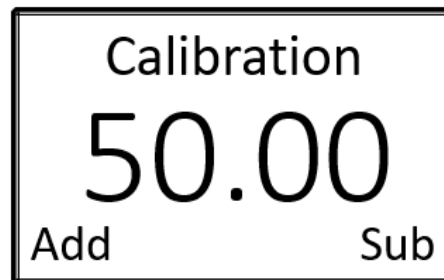

NOTICE

If the sensor responds extremely slow, or does not respond to the applied gas, it may indicate a failed sensor element. The sensor element will need to be replaced before completing the null and calibration process.

6. When calibration is complete, detach the Calibration Adapter Kit from the sensor housing and reattach the sensor housing cap. Press the **MENU** button to advance to the Low Alarm Setting screen.

4.2.3 CALIBRATING THE SENSOR (AUTO CAL)

You should **ONLY** perform the calibration of the sensor after the null process has been completed. For best results, use 50% of the sensor scale of your target gas in an air balance with a flow rate of 0.25 to 0.5 LPM.

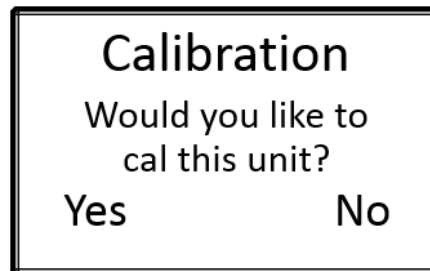

1. Press the **ADD** button to select “Yes” to begin the calibration process and to advance to the calibration confirmation screen. If you do not wish to calibrate the sensor, press the **SUB** button to select “No” to advance to the sensor radio address setting screen.

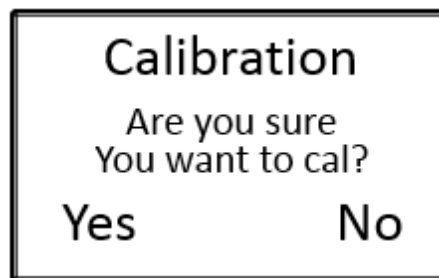

2. Press the **ADD** button to select “Yes” to confirm that you want to calibrate the sensor and to continue to the concentration setting screen. If you do not wish to continue to calibrate the sensor, press the **SUB** button to select “No” to advance to the sensor radio address setting screen.

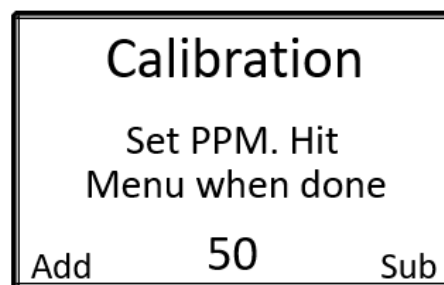

3. Use the **ADD** and **SUB** buttons to adjust the concentration to the calibration gas being used. Press the **MENU** button to save the gas concentration setting and to advance to the calibration start screen.
4. Affix a Calibration Adapter Kit (sold separately) to the sensor housing of the device.
5. Affix a regulator to the calibration gas bottle.

6. Attach the tubing on the Calibration Adapter Kit to the regulator on the calibration gas bottle.

Calibration
Apply gas then
hit menu button

7. Ensure that the gas is flowing and press the **MENU** button to begin calibrating the sensor, the unit will automatically begin the calibration process, the amount of time on the timer will vary based on the gas type. During calibration, the display will show a countdown of the time remaining until the process is complete.

Calibration
It will be caled
At the end of timer
120



NOTICE

Once the calibration countdown has started, the process cannot be stopped without disconnecting the power from the unit.

8. When calibration is complete, detach the Calibration Adapter Kit from the sensor housing and reattach the sensor housing cap. Press the **MENU** button to advance to the Low Alarm Setting screen.

Calibration
Unit is now caled
to 50 PPM.
Reading: 50

4.3 SENSOR ALARM SETTINGS

The OI-6000 has two alarm settings: LOW alarm and HIGH alarm. All alarm set-points are field adjustable up to 60% of the full scale gas concentration. The factory default setting on the OI-6000 for the LOW alarm is 10% of full scale and 15% of full scale for the HIGH alarm. The LOW alarm set-point should **NEVER** be programmed to a higher setting than the HIGH alarm set-point.

Both alarms are configurable to activate on either a rising or falling level of gas. Most gas types activate alarms on rising levels of gas. Oxygen is a special case and by default activates the LOW alarm when the detected gas concentration FALLS below the LOW alarm set-point and the HIGH alarm when the detected gas concentration RISES above the HIGH alarm set-point. The factory default setting for all other gas types is to activate when the detected gas RISES above the alarm set-point.

On the “L” model when the gas concentration detected at the sensor meets or exceeds the LOW alarm set-point, the LOW alarm LED color will illuminate and slow strobe, by default amber. When the gas level meets or exceeds the HIGH alarm set-point, the HIGH alarm LED color will illuminate and strobe faster, red by default and the piezo alarm will activate by default. The alarm LED color will not switch back to steady green until the gas level reading at the sensor has fallen 10% below the alarm set-points or until the alarm is manually reset at the device, dependent upon the relay latching/non-latching settings.

On the “GL” model when the gas concentration detected at the sensor meets or exceeds the LOW alarm set-point, the LED will have a slow strobe affect. When the gas level meets or exceeds the HIGH alarm set-point, the LED will have a faster strobe and the piezo alarm will activate by default. The LED will not switch back to constant green until the gas level reading at the sensor has fallen 10% below the alarm set-points or until the alarm is manually reset at the device, dependent upon the relay latching/non-latching settings.

4.3.1 SENSOR LOW ALARM SETTING

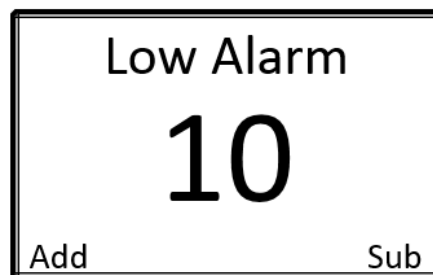

1. Use the **ADD** and **SUB** buttons to increase and decrease the LOW alarm set-point, respectively.
2. Press the **MENU** button to save the desired setting and to advance to the sensor LOW alarm rise/fall setting screen.

4.3.2 SENSOR LOW ALARM RISE/FALL SETTING



1. Use the **ADD** and **SUB** buttons to select between activation on a Rising or a Falling gas level, respectively.
2. Press the **MENU** button to save the desired setting and to advance to the sensor HIGH alarm setting screen.

4.3.3 SENSOR HIGH ALARM SETTING

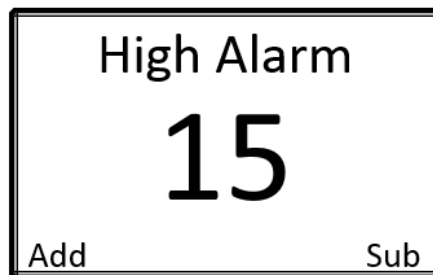

1. Use the **ADD** and **SUB** buttons to increase and decrease the HIGH alarm set-point, respectively.
2. Press the **MENU** button to save the desired setting and to advance to the sensor HIGH alarm rise/fall setting screen.

4.3.4 SENSOR HIGH ALARM RISE/FALL SETTING



1. Use the **ADD** and **SUB** buttons to select between activation on a Rising or a Falling gas level, respectively.
2. Press the **MENU** button to save the desired setting and to advance to setting the radio address (if you have a radio module installed), otherwise you will return to Normal Operating Mode.



NOTICE

- ◆ The alarms will **NOT** activate, even in the presence of gas, until you have exited the menu mode for approximately 1 minute.
- ◆ For non-latching alarms, the alarms will **NOT** deactivate until the gas level reading at the sensor has fallen 10% below the alarm set-point.

4.4 SENSOR RADIO ADDRESS

The OI-6000 radio address is adjustable from 1 to 255, each sensor assembly on the network needs a unique radio address in order to avoid a fault at the receiving monitor. The default radio address is 1.

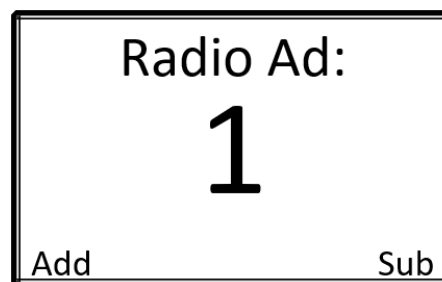

1. Use the **ADD** and **SUB** buttons to increase and decrease the sensor radio address, respectively.
2. Press the **MENU** button to save the desired setting and to exit the operation settings menu, and to return the device to normal operating mode.

4.5 MANUAL RESET FOR ACTIVATED LATCHING ALARMS

Alarms set to latching will not deactivate until the alarms are manually reset at the device. When latching alarms have been activated, refer to the following instructions for how to manually deactivate the alarms on your device:

1. Verify that the gas level reading is below the alarm level setting.
2. Press the **MENU** button to deactivate latching alarm(s).



NOTICE

- ◆ The gas level reading **MUST** be below the alarm level setting before the alarm can be deactivated.
- ◆ Press the **MENU** button **ONLY** once to deactivate the latching alarm(s). Pressing the **MENU** button more than once will activate and open the operation settings menu.

5 PRODUCT MAINTENANCE

5.1 SCHEDULED MAINTENANCE

Otis recommends that our equipment be calibrated a **MINIMUM** of every 90 days, and **STRONGLY** advise that calibration be performed every 30 days. Without knowing the specific application, sensor assembly location, gas exposure and other factors, the company recommends monthly calibrations – assuming no damage or potential damage has occurred to the sensor and that there has not been a power outage to the sensor assembly. If damage has occurred or the power supplied to the sensor has changed, a calibration should be completed immediately.

Scheduled maintenance should include the null and calibration of the sensor and an alarm test. Consult the Sensor Calibration and Alarm Test sections of this manual for further information and instructions on how to perform these procedures.

The sensor head should be kept free of airborne particles, dirt, mud, spider webs, bugs and insects, and/or any other debris that could potentially cover or coat the sensor. Keeping the sensor head clear of foreign articles will allow for proper operation of the device. A brief inspection during scheduled maintenance should suffice, but dependent upon the location and the environment in which the unit is installed, more frequent inspections may be warranted.

The sensor assembly may be adversely affected by the exposure to certain airborne substances. Loss of sensitivity or corrosion may be gradual, if such materials are present in sufficient concentrations. The performance of the device may be impaired during operation in the presence of substances that can cause corrosion on gold plating. Continuous and high concentrations of corrosive gases may also have a detrimental long-term effect on the product's service life. The presence of such substances in an area does not preclude the use of this device, but the likelihood of the shortened lifetime of the sensor element, as a result, should be noted. Use of the sensor assembly in these environments may require more frequently scheduled maintenance to ensure safe and reliable system performance.

5.2 SENSOR REPLACEMENT

The sensor elements used in the OI-6000 detects gas in either % or PPM concentrations, this element must be fully functional in order for the system to operate correctly. Otis recommends replacing the sensing element whenever a slow response to gas is observed during the normal calibration process. After replacing the sensing element the device **MUST** then be nulled and calibrated for proper operation of the device.



CAUTION

- ◆ The internal components can be static sensitive. Use caution when opening the enclosure and handling internal components.
- ◆ **DO NOT** use any metal objects or tools to remove the sensing element from the sensor adapter board.

1. **Press and hold** the **SUB** button for approximately 6 seconds, until “OFF” shows on the display screen.
2. Unscrew and remove the sensor housing cap from the sensor housing base. Set aside.
3. Using the thumb and forefinger, gently unplug the sensing element from the sensor housing board.

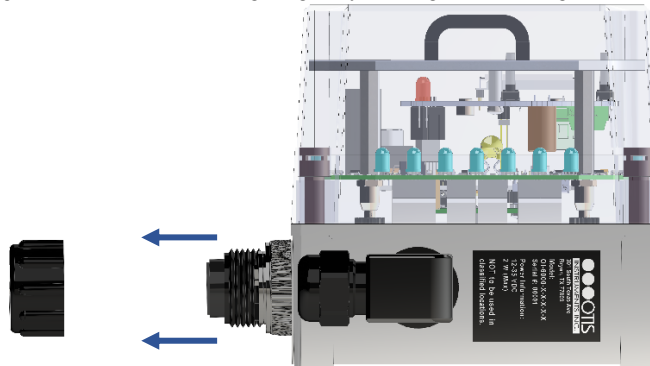

4. Plug in the new sensing element into the sensor housing board. Ensure that the pins on the sensing element align with the sockets on the sensor housing board.

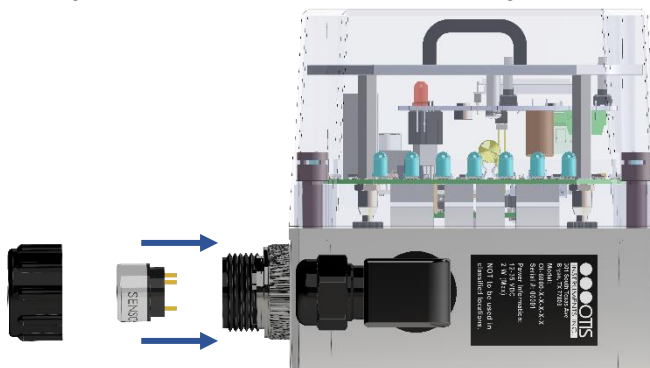

5. Screw the sensor housing cap back onto the sensor housing base, ensuring that the sensor housing cap is only tightened hand tight.

5.3 PRODUCT TROUBLESHOOTING

OI-6000 Fault Codes		
Problem	Cause(s)	Solution(s)
F1 Check Sensor Cable	1. The control board has lost communication with the digital sensor interface adapter board.	1. Check connection between the sensor housing connector header and the digital sensor interface adapter board plug-in. 2. Replace the sensor interface adapter board
F4 Check Sensor Board	1. The control board has lost communication with the sensor interface board.	1. Replace the sensor interface board.
F5 Try to Null Again	1. The unit did not null correctly, due to: <ul style="list-style-type: none"> • the presence of gas, • a sensor error, or • a sensor interface board error. 	1. Re-null the device in clear air. 2. Replace the sensor element. 3. Replace the sensor interface board.
F6 Try to Calibrate Again	1. The unit did not calibrate correctly, due to: <ul style="list-style-type: none"> • the absence of gas, • a sensor error, or • a sensor interface board error. 	1. Recalibrate the sensor element and verify that gas is present during calibration. 2. Replace the sensor element. 3. Replace the sensor interface board.
F14 Check Radio	1. The sensor assembly has lost communication with the Primary Monitor <ul style="list-style-type: none"> • Network ID is incorrectly configured. • Sensor assembly is obstructed/too far from the Primary Monitor. • Radio module is not working in the sensor assembly 	1. Check that the Network ID on the sensor assembly matched the Primary Monitor Network ID 2. Move the sensor assembly away from the obstruction or use a high gain antenna. 3. Replace sensor radio module.

When replacing the sensor element, the detector must be nulled and calibrated. System faults will activate the fault terminal on the device.

5.4 PRODUCT REPLACEMENT PARTS AND ACCESSORIES

While not all of the components on the OI-6000 can be field-replaced, there are several parts that are replaceable by an Otis Approved Service Technician.

To purchase accessories/replacement parts for your device, contact the sales representative of this product for assistance.

Product Replacement Parts and Accessories OI-6000-X-X-X-L-X-C and OI-6000-X-X-X-GL-X-C	
External Replacement Parts	
Part Name	Otis Part Number
Main Enclosure with Lid	OI-6000C-L-ENCL-KIT
Electrochemical Sensor Housing Base	OI-254NXP-BASE
IR/PID Sensor Housing Base	OI-140NXP-BASE
Sensor Housing Cap with Screen	OI-254NXP-CAP
Internal Replacement Parts	
Part Name	Otis Part Number
Control board with LCD Screen	OI-6000L-CB-KIT
Radio/Light Board – No Radio Module Included	OI-6000C-RLB-PCA
Radio/Green Light Board – No Radio Module Included	OI-6000C-RGLB-PCA
GEN II 900 MHz Radio Module with Flexible Antenna	OI-RADIO-900-C-KIT
GEN II 2.4 GHz Radio Module with Flexible Antenna	OI-RADIO-2.4-C-KIT
900 MHz Flexible Adhesive Internal Antenna	OI-AN-900-CUBE
2.4 GHz Flexible Adhesive Internal Antenna	OI-AN-2.4-CUBE
Digital Sensor Interface Adapter Board	OI-6000-NXP-DB-PCA
Infrared Sensor Interface Adapter Board	OI-2011-NXP-S
PID Sensor Interface Adapter Board <i>*Specify PPM Scale When Ordering (10, 20, 50, 1K, or 2K)</i>	OI-2014-NXP-S-[Scale]*
Electrochemical Sensor Interface Board <i>**Specify Gas Type When Ordering</i>	OI-2015-NXP-S-[Gas Type]**
Oxygen Sensor Interface Board	OI-2016-NXP-S-O2
Product Accessories	
Part Name	Otis Part Number
Otis Magnetic Tool	OI-420
Filter for Dusty Environments	OI-2000-CAP-FILTER
Calibration Adapter Kit	OI-410-NXP

APPENDICES

- APPENDIX A: INTRODUCTION TO 4-20 mA CURRENT LOOP SIGNALS
- APPENDIX B: MODBUS COMMUNICATIONS
- APPENDIX C: MODBUS REGISTER MAP
- APPENDIX D: OTIS INSTRUMENTS PRODUCT WARRANTY STATEMENT
- APPENDIX E: INFORMATION ABOUT RMA SERVICE REPAIRS
- APPENDIX F: INFORMATION ABOUT RMA RETURNS FOR CREDIT

APPENDIX A: INTRODUCTION TO 4-20 MA CURRENT LOOP SIGNALS

This appendix is only an introduction. The information should serve as a brief overview of 4-20 mA current loop signal ranges and should not be considered a complete reference for proper implementation or use.

Industry standards pertaining to 4-20 mA current loop signals and other aspects of electronics are assumed to be known by the technician. For proper connection to a monitor or Programmable Logic Controller (PLC), refer to the manufacturer's specific manual or instructions for that device.

OVERVIEW

When using 4-20 mA wired output signal devices, the 4-20 mA defines the current loop analog signal range, with 4 mA representing the lowest end of the range and 20 mA the highest. The relationship between the current loop and the gas value is linear. In addition, Otis devices use values below 4 mA to indicate special status conditions, as shown below:

4-20 mA Ranges	
Current	Detector Status
2.5 mA	Sensor Fault
3 mA	Sensor in Menu Mode
3.5 mA	Sensor in Calibration Mode

The 4 mA allows the receiving monitor/PLC to distinguish between a zero signal, a broken wire, or an unresponsive instrument. Benefits of 4-20 mA convention are that it is: an industry standard, low-cost to implement, can reject some forms of electrical noise, and the signal does not change value around the "loop" (as opposed to voltage). The key advantage of the current loop is that the accuracy of the signal is not affected by a potential voltage drop in the interconnected wiring. Even with significant resistance in the line, the current loop transmitter will maintain the proper current for the device, up to its maximum voltage capability.

Only one current level can be present at any time. Each device that operates via a 4-20 mA current loop signal must be wired directly to the monitoring device. Units that are wired in a daisy chain configuration for the 4-20 mA current loop signal will not properly transmit data communications to the monitoring device.

CALCULATIONS

$$I_{(4-20)} = \left(\frac{(16)(\text{value})}{\text{scale}} \right) + 4$$

$I_{(4-20)}$ = Current of loop, measured in mA

value = ppm (or %) of gas concentration

scale = full scale of sensor

Sensor Element Scale Ranges			
Sensor Type	Gas Type	Formula	Range
Electrochemical (EC)	Hydrogen Sulfide	H2S	0-100 PPM
Electrochemical (EC)	Hydrogen Sulfide (High Range)	H2S2K	0-2000 PPM
Electrochemical (EC)	Sulfur Dioxide	SO2	0-20 PPM
Electrochemical (EC)	Oxygen	O2	0-25 %
Electrochemical (EC)	Carbon Monoxide	CO	0-1000 PPM
Electrochemical (EC)	Chlorine	CL2	0-20 PPM
Electrochemical (EC)	Hydrogen Chloride	HCL	0-30 PPM
Electrochemical (EC)	Ammonia	NH3	0-100 PPM
Electrochemical (EC)	Ammonia (Medium Range)	NH3300	0-300 PPM
Electrochemical (EC)	Ammonia (High Range)	NH3A	0-1000 PPM
Electrochemical (EC)	Hydrogen	H2	0-4 % Vol
Electrochemical (EC)	Chlorine Dioxide	CLO2	0-1 PPM
Electrochemical (EC)	Hydrogen Cyanide	HCN	0-50 PPM
Electrochemical (EC)	Nitrogen Dioxide	NO2	0-20 PPM
Electrochemical (EC)	Phosphine	PH3	0-5 PPM
Infrared (IR)	Carbon Dioxide	CO2	0-5 %
Infrared (IR)	Combustible Gas	LEL	0-100 %
Photo Ionization Detector (PID)	Volatile Organic Compounds	VOC10	0-10 PPM
Photo Ionization Detector (PID)	Volatile Organic Compounds	VOC20	0-20 PPM
Photo Ionization Detector (PID)	Volatile Organic Compounds	VOC50	0-50 PPM
Photo Ionization Detector (PID)	Volatile Organic Compounds	VOC1K	0-1000 PPM
Photo Ionization Detector (PID)	Volatile Organic Compounds	VOC2K	0-2000 PPM

Actual ranges may vary with our product. For inquiries beyond the information and instructions provided, contact the sales representative of this product for assistance.

MEASURING CURRENT

If the value measured is 0 mA, then: the loop wires are broken, the sensor assembly is not powered up, the sensor assembly is malfunctioning, or the monitor is malfunctioning. A digital multi-meter (DMM), or current meter, may be used in conjunction with the monitoring device and/or to test the 4-20 mA current loop signal. To measure the current, place the meter probes in line with the current loop.

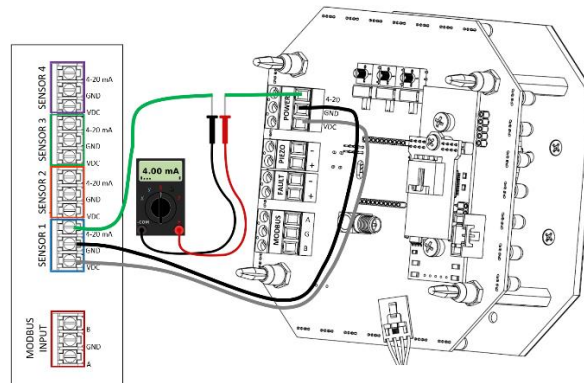

APPENDIX B: MODBUS COMMUNICATIONS

Certain Otis Monitors have the capability of accepting Modbus sensor inputs for data communications with OI-6000 series detectors. Modbus is a communication protocol that uses an RS-485 serial connection, and can accept a number of different devices.

Based on the type of circuit used, there is a limit on how many devices that can be connected to a Modbus sensor network. Otis Monitors currently allow a maximum of 32 devices on a single network. The data is transferred along the Modbus network at a specified Modbus baud, or rate of speed. Though small, networks that have a high number of devices connected will incur a small, proportional delay in the communication transfer of data.

WIRING CONFIGURATIONS

A daisy chain is a wiring scheme in which multiple devices are wired together in a sequence, or in a ring. Daisy chains may be used for power, analog signals, digital data, or a combination thereof. For the purposes of Otis devices, the term daisy chain refers to multiple devices connected in a series to form a single long line of devices, connected via the wiring patterns embedded within each device.

Twisted pair cabling is a type of wiring in which two conductors of a single circuit are twisted together for the purposes of canceling out electromagnetic interference (EMI) from external sources as well as “crosstalk” between neighboring pairs. In electronics, crosstalk is any phenomenon by which a signal transmitted on one circuit or channel of a transmission system creates an undesired effect in another circuit or channel. Otis products require twisted pairs for all wired Modbus connections.

Twisted pair cables are often shielded in an attempt to further prevent EMI. Electromagnetic shielding provides an electric conductive barrier to attenuate electromagnetic waves external to the shield and provides a conduction path by which induced currents can be circulated and return to the source, via ground reference connection. These cables are referred to as shielded twisted pairs (STP) and are recommended for operation areas with high noise levels.

PROPER CONNECTION

The distance of the Modbus connection from the gas detection device to the monitor cannot exceed 4,000 feet. In the instance of daisy-chained devices, this applies to the last sensor connected on the line. Connection distances of 100 feet, or less, require 22 to 24 gauge wire. Connection distances that range more than 100 feet require 18 to 20 gauge wire.

For more information on properly wiring a daisy chain network of devices for Modbus, consult the following diagram.

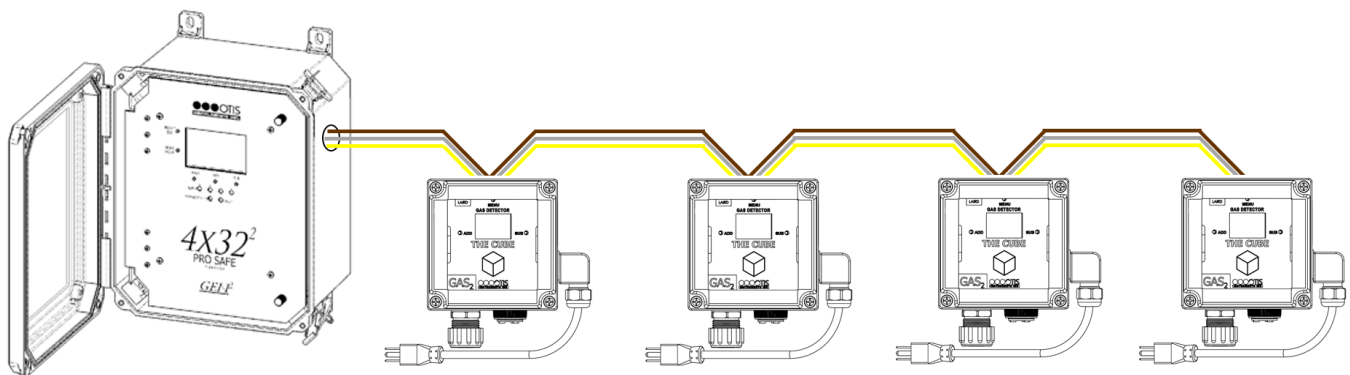

The signal wire of each unit is run to the signal terminal of the neighboring sensor. With each device connected to the previous device via the signal wire, a “chain” is created, with the first device in the chain directly connected to the monitor.

RS-485 Modbus Connection Distances for Electrical Wiring

Distance	Length	Gauge Size	Twisted Pairs
Short	< 100 Feet	22 to 24 Gauge	Shielded, in areas of high noise
Medium	101 Feet to 1,000 Feet	18 to 20 Gauge	Shielded, in areas of high noise
Long*	1,000 Feet to 4,000 Feet	18 to 20 Gauge	Shielded, in areas of high noise

(*) Terminating resistor may be required for the last device in the daisy-chain.

APPENDIX C: MODBUS REGISTER MAP

OI-6000 MODBUS REGISTER MAP

Register Address (Hex)	Register Address (Dec)	Data Description	R/W	Length	Unit	Valid Response(s)
1	1	Gas Reading	R	2	FLOAT	Numerical Gas Reading
3	3	Modbus Address	R	1	UINT	0 – 247
4	4	Gas Type	R	1	ENUM	0 – 26, see below
5	5	Unit Type	R	1	ENUM	0 – 1, see below
6	6	Major Revision	R	1	UINT	0 – 100
7	7	Minor Revision	R	1	UINT	0 – 9
8	8	Mode of Sensor	R	1	ENUM	0 – 7, see below
9	9	Voltage Reading	R	2	FLOAT	12V – 35V
B	11	Fault Code	R	1	ENUM	0 – 6, see below
C	12	Sensor Type	R	1	ENUM	0-4, see below
E†	14†	Relay 1 Setting	R	2	FLOAT	1 – 32000
10†	16†	Relay 2 Setting	R	2	FLOAT	1 – 32000
16	22	Precision	R	1	INT	0 – 3
17†	23†	Relay Setting	R	1	BFLD	See Relay Setting Table
18	24	Days Since Last Null	R	1	UINT	0 – 60000 (>60000) Default to “Never”
19	25	Calibration Type	R	1	ENUM	0 – 1
1A	26	Auto-Calibration Value	R	2	FLOAT	Numerical Gas Reading
1C	28	Days Since Last Calibration	R	1	UINT	0-60000 (>60000) Default to “Never”
1E	30	Relay 1 State	R	1	INT	0 – Relay Inactive 1 – Relay Active
1F	31	Relay 2 State	R	1	INT	0 – Relay Inactive 1 – Relay Active
20	32	Relay 1 Reset	R/W	1	INT	Read as 0 Write 1 to reset Relay 1 state
21	33	Relay 2 Reset	R/W	1	INT	Read as 0 Write 1 to reset Relay 2 state

Register Address 1: Hexadecimal numbers

Register Address 2: Decimal numbers

R/W: Read/Write capable data

R: Read-only data

FLOAT: Floating point number

ENUM: Enumeration

UINT: Unsigned integer

INT: Integer

BFLD: Bit Field

(*): Limited by precision

OI-6000 MODBUS REGISTER MAP ENUMERATION KEYS

Register Address 4: Gas Type

Response	Gas Type
0	H2S – Hydrogen Sulfide
1	SO2 – Sulfur Dioxide
2	O2 – Oxygen
3	CO – Carbon Monoxide
4	CL2 – Chlorine
5	CO2 – Carbon Dioxide
6	LEL – Combustible Gas
7	VOC – Volatile Organic Compounds
9	HCL – Hydrogen Chloride
10	NH3 – Ammonia
12	CLO2 – Chlorine Dioxide
13	HCN – Hydrogen Cyanide
14	F2 - Fluorine
15	HF – Hydrogen Fluoride
16	CH2O - Formaldehyde
17	NO2 – Nitrogen Dioxide
18	O3 - Ozone
26	PH3 – Phosphine
27	HBr – Hydrogen Bromide
28	EtO – Ethylene Oxide
29	CH3SH – Methyl Mercaptan
30	AsH3 - Arsine

Register Address 5: Unit Type

Response	Unit Type
0	PPM
1	%

Register Address 8: Mode of Sensor

Response	Sensor Mode
0	Normal Operating Mode
1	Null Mode
2	Calibration Mode
3	Relay Test Mode
5	Diagnostic Mode
6	Advanced Mode
7	Administrator Mode

Register Address B/11: Fault Code

Response	Fault Type
0	No Fault
1	Loss of Communication with Sensor Board
4	Loss of Communication with Sensor Element/Housing
5	Null Error
6	Calibration Error
14	No Primary Monitor

Register Address C/12: Sensor Type

Response	Sensor Type
0	EC – Electrochemical
1	IR – Infrared
2	CB – Catalytic Bead
4	PID – Photo Ionization Detector

Register Address 17/23: Relay Setting

Bit	Relay Setting	Function
5	Alarm 2: Rise/Fall Setting	0 – Fall
		1 - Rise
4	Alarm 1: Rise/Fall Setting	0 – Fall
		1 - Rise
3	Not used on this model	Always 0
2	Not used on this model	Always 0
1	Alarm 2: Latch/UnLatch	0 – UnLatch
		1 - Latch
0	Alarm 1: Latch/UnLatch	0 – UnLatch
		1 - Latch

Register Address 19/25: Calibration Type

Response	Calibration Type
0	Manual Calibration
1	Auto Calibration

APPENDIX D: PRODUCT WARRANTY STATEMENT

Warranty Coverage

Otis Instruments, Inc., 301 S. Texas Avenue, Bryan, Texas, 77803 (“Otis”) warrants the manufacture of all Otis hardware, firmware, software, components, and product accessories (“Otis Products”), contained in the original packaging, against defects in materials and workmanship when used normally in accordance with Otis’ published guidelines for a period of ONE (1) YEAR from the date of original purchase by the end-user/purchaser from the manufacturer or from the product’s authorized sellers/distributors (“Warranty Period”). Otis’ published guidelines include but are not limited to information contained in technical specifications, operation/user manuals and service communications.

Warranty Exclusions

This Warranty does not apply to any non-Otis manufactured products, even if packaged or sold with Otis Products. Otis does not warrant that the operation of their manufactured products be uninterrupted or error-free. Otis is not responsible for damage arising from failure to follow instructions relating to the Otis Product’s use.

This Warranty does not apply to: (a) batteries; (b) protective coatings that are designed to diminish over time, unless failure has occurred due to a defect in materials or workmanship; (c) cosmetic damage, including scratches, dents and chipping of paint; (d) damage, caused by use with another product accident, abuse, misuse, or any external cause of force majeure; (e) damage, caused by operations outside of Otis’ published guidelines; (f) damage, caused by service performed by anyone who is not a representative of Otis or who is not an Otis authorized service provider; (g) damage, caused by product modifications, alterations of functionality or capability; (h) defects, caused by normal wear and tear or otherwise due to the normal aging of the Otis product, or (i) any product in which a product-labeled serial number has been removed, defaced, or altered in any way.

If examination and assessment discloses that the alleged defect in the product does not exist, or was caused by the end-user/purchaser (or any third-party) misuse, neglect, improper wiring or installation, testing or calibrations, the Otis Product Warranty will be null and void. Any unauthorized attempts of repair, modification, or any other cause of damage beyond the range of the Otis Product’s intended use, including force majeure, voids all liability of the manufacturer.

Replaceable Batteries and Sensor Elements

All batteries supplied to the end-user/purchaser by Otis are covered, from the date of shipment, for ninety (90) days, unless otherwise excluded and noted†. Sensor elements supplied to the end-user/purchaser by Otis have individual Warranty information, regarding Product Lifetime and Warranty. For more information on sensor element Warranties, refer to the Otis published guidelines.

End-User Responsibilities

End-user/purchaser should perform periodic null and calibration procedures, recommended every thirty (30) days, not to exceed ninety (90) days, for optimal performance, proper maintenance, and as a precaution against possible operational failures.

Before the end-user/purchaser receives the initial Warranty service, Otis may require the end-user to furnish proof of purchase details, respond to questions designed to assist with diagnostics, and follow Otis procedures for obtaining Warranty service.

For Otis Products that feature data logging and data storage, the end-user/purchaser should generate a separate backup copy of the information contained on the device, before submitting the Otis Product for Warranty service. Otis Warranty service is not responsible for any loss of data or settings stored on the device while under service/repair.

Otis Products submitted to Warranty service must be returned in their complete assembly, as originally shipped from the manufacturer. Warranty service will not service/repair Otis Products that are not in their original condition. For Otis Gas Detection Products, also referred to as Sensor Assemblies, the end-user/purchaser must remove external antenna(s), rain guard(s), and all batteries before shipping.

Otis Products submitted to Warranty service will be returned, as originally configured, with the factory default settings, upon completion of the service/repair. Otis is not responsible for maintaining end-user/purchaser settings, resetting the null, recalibration, or any other preparations for reinstallation and/or reintegration of the device.

Warranty Service

Please refer to the Otis published guidelines and/or the Otis website before seeking Warranty service. If the Otis Product continues to malfunction/error after consulting these resources, please contact the product's authorized seller/distributor or consult the Otis RMA/Service webpage at www.otisinstruments.com/service for information and instructions on submitting the Otis Product for Warranty service.

Otis Warranty service, at their discretion, will (a) repair the device using new or previously used parts that are equivalent to new in performance and reliability, (b) replace the Otis Product with a device that is at least functionally equivalent to the Otis product and is formed from new and/or previously used parts that are equivalent to new in performance and reliability, or (c) exchange the Otis Product for a refund of your purchase price, when an Otis Product is submitted.

Otis Warranty service will treat service/repairs as quick-turn exchanges. Otis Warranty service does not replace any board level components, (i.e. magnetic switches, resistors, capacitors, relays, etc.).

Otis Products may require the replacement of certain user-installable parts or Otis Products. A replacement part or Otis Product, including a user-installable part that has been installed in accordance with instructions provided by Otis, assumes the remaining term of the Warranty, or ninety (90) days from the date of replacement or repair, whichever provides the longer coverage for the end-user/purchaser. When an Otis product or part is replaced, or a refund is provided, any replacement item becomes your property and the replaced or refunded item becomes Otis' property.

For Otis Products requiring Warranty service that are located outside of the United States, the customer is responsible for compliance of all import/export laws and regulations/requirements, including associated taxes and other charges. Where applicable, Otis Warranty service may repair/replace products with parts that comply with local/regional standards.

Otis Products covered under Warranty will receive service/repairs at no charge to the end-user/purchaser. Otis Products not under Warranty will be diagnosed for service/repair and the end-user/purchaser will be notified of the recommended service/repairs and applicable charges. The completion of the service/repairs, or the return of the unrepaired product, is at the discretion of the end-user/purchaser. Charges assessed for service/repair on Otis Products not under Warranty are at a rate of list cost minus dealer/distributor percent discount.

Upon completion of Warranty service, Otis Warranty service will return the device to the end-user/purchaser. Please consult the Otis website for more information concerning shipping costs for Warranty service.

Otis reserves the right to change the method by which Otis Warranty service is provided. Otis also reserves the right to change the Otis Product's eligibility to receive a particular method of service. Warranty service may be limited for Otis Products in the country where the manufacturer or product's authorized sellers/distributors originally sold the product. Warranty service options, parts availability and response times may vary.

(†) Battery for the GEN II Model OI-6940 "The Quad" WireFree Explosion-Proof Battery-Powered Multi-Gas Detector is excluded from the ninety (90) day warranty policy.

APPENDIX E: INFORMATION ABOUT RMA SERVICE REPAIRS

Otis Instruments, Inc. offers technical support to our customers. Please contact the Otis Instruments RMA Service Department for technical support, repair requests, warranty inquiries, end-user commission reports, dealer/distributor support, and Modbus setup inquiries and services.

This appendix is for information purposes only. Please visit our website at www.otisinstruments.com/RMA to obtain the latest version of the Otis Instruments, Inc. Return Material Authorization (RMA) Service Repair Form and shipment instructions.

IMPORTANT INFORMATION

All RMA Service repairs must be shipped to OTIS Instruments / Repairs, 301 South Texas Ave., Bryan, Texas 77803.

To ensure that RMA Service repairs are processed as timely as possible, the Otis Instruments, Inc. Return Material Authorization (RMA) Service Repair Form must be completed in its entirety and included within the box at the time of shipment. Customer contact information and product information, including model number, serial number, and specific reason(s) for service, will need to be accessible in order to complete the form. Shipments received that do not include the form, or if the form is incomplete, will be returned (unrepaired) COD to the customer.

Products/parts must be shipped in the proper packaging and the shipping materials must adhere to ESD safety precautions, as applicable. The entire assembly, as originally shipped from the manufacturer, must be returned for repair. When shipping sensor assemblies (gas detectors), the antenna, rain guard, and battery must be removed prior to shipment. Failure to adhere to these instructions will result in the products/parts being returned to sender.

Once the RMA Service Repair Form is received by the Otis Instruments RMA Service Department, a RMA Service number will be generated. The RMA Service number will be sent to the email address provided for verification of receipt.

RMA Service quotes have a thirty (30) day expiration. Quotes that do not receive a purchase order response within thirty (30) days of the quote will be canceled and all products/parts will be returned (unrepaired) COD to the customer.

Discontinued products may not be returned for RMA Service for repair. For a listing of the Otis Instruments, Inc. discontinued products, please visit our website at www.otisinstruments.com/RMA. If your product/part has been discontinued, please contact your local sales representative for replacement options.

All RMA Service repairs are treated as quick-return exchanges. Otis Instruments, Inc. does not replace board level components (i.e. magnetic switches, resistors, capacitors, relays, etc.).

There is no charge for RMA Service repairs that are within the specified warranty period. For a copy of the Otis Instruments, Inc. Product Warranty Statement, please visit our website at www.otisinstruments.com/official_statements. Products/parts that are not within the specified warranty period will result in a charge to the customer for service.

Products/parts that fall within the Otis Instruments, Inc. operating specifications deemed defective due to customer misapplication will be returned as is, and may result in a per unit evaluation fee to the customer. Otis Instruments, Inc. reserves the right to return customer-damaged or no-fault found products/parts from the Otis Instruments RMA Service Department COD to the customer.

If advanced replacement is required, please contact the Service Department for more information.

INTERNATIONAL RMA SERVICE REPAIRS

The customer is responsible for complying with all import/export requirements for shipment of RMA/Service repairs to Otis Instruments, Inc.

OTIS INSTRUMENTS RMA SERVICE DEPARTMENT

Otis Instruments / Repairs
301 South Texas Ave.
Bryan, Texas 77803
Office: 979.776.7700
Fax: 979.776.7719
service@otisinstruments.com
www.otisinstruments.com/RMA

APPENDIX F: INFORMATION ABOUT RMA RETURNS FOR CREDIT

Without exception, all RMA Returns for Credit to Otis Instruments, Inc. must receive prior approval before shipment. Otis Products received that do not have prior approval will be returned (uncredited) COD to the customer. For inquiries and approval for RMA Returns for Credit, please contact your local sales representative.

This appendix is for information purposes only. Please visit our website at www.otisinstruments.com/RMA to obtain the latest version of the Otis Instruments, Inc. Return Material Authorization (RMA) Return for Credit Form and shipment instructions.

IMPORTANT INFORMATION

All RMA Returns for Credit must be shipped to OTIS Instruments / RMA Returns, 301 S. Texas Avenue, Bryan, Texas 77803.

Product/part returns must be in their original condition and packaging, as shipped from the manufacturer. Returns that do not meet these specifications will be rejected for return for credit. Otis Instruments, Inc. reserves the right to return products/parts deemed to be inadequate (uncredited) COD to the customer.

To ensure that Returns for Credit are processed as timely as possible, the RMA Return for Credit Form must be completed in its entirety and included within the box at the time of shipment. Customer contact information and product information, including model number, serial number, and specific reason(s) for service, will need to be accessible in order to complete the form. Shipments received that do not include the form (or if the form is incomplete) will be returned (uncredited) COD to the customer.

Once the shipment is received by the Otis Instruments RMA Returns Department, a RMA number will be generated. The RMA number will be sent to the email address provided for verification of receipt.

All RMA Returns for Credit will be processed for approval by the manufacturer.

A restocking fee of 15% will be charged for all products/parts returned to the manufacturer.

Discontinued products may not be returned for credit. For a listing of Otis Instruments, Inc. discontinued products, please visit our website at www.otisinstruments.com/RMA. If your product/part has been discontinued, please contact your local sales representative for replacement options.

INTERNATIONAL RMA SERVICE REPAIRS

The customer is responsible for complying with all import/export requirements for shipment of RMA/Service repairs to Otis Instruments, Inc.

OTIS INSTRUMENTS RMA RETURNS DEPARTMENT

Otis Instruments / RMA Returns
301 S. Texas Avenue
Bryan, Texas 77803
Office: 979.776.7700
Fax: 979.776.7719
service@otisinstruments.com
www.otisinstruments.com/RMA

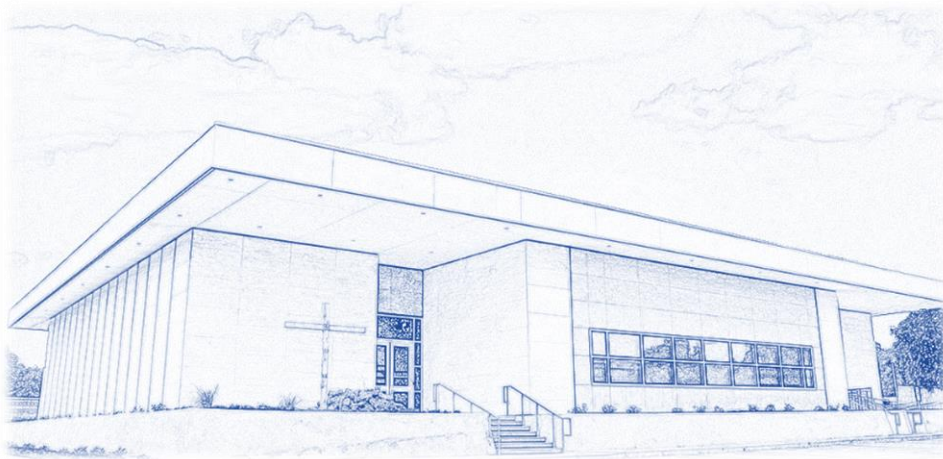

Otis Instruments

301 S. Texas Avenue, Bryan, Texas 77803

Tel: 979.776.7700 Fax: 979.776.7719

sales@otisinstruments.com

service@otisinstruments.com

www.otisinstruments.com