

1 TABLE OF CONTENTS

1	TABLE OF CONTENTS
2	MACHINE AND MANUFACTURER IDENTIFICATION
3	DECLARATION OF CONFORMITY
4	MACHINE DESCRIPTION
5	HANDLING AND TRANSPORT
6	GENERAL WARNINGS
7	SAFETY INSTRUCTIONS
8	FIRST AID RULES
9	GENERAL SAFETY RULES
10	TECHNICAL DATA
11	PERFORMANCE SPECIFICATIONS
12	ELECTRICAL DATA
13	OPERATING CONDITIONS
14	ENVIRONMENTAL CONDITIONS
15	ELECTRICAL POWER SUPPLY
16	DUTY CYCLE
17	PERMITTED AND NON-PERMITTED FLUIDS
18	INSTALLATION
19	POSITIONING, CONFIGURATIONS AND ACCESSORIES
20	NOTES ON SUCTION AND DELIVERY LINES
21	CONNECTIONS
22	ELECTRICAL CONNECTIONS
23	PIPING CONNECTIONS
24	INITIAL START-UP
25	EVERY DAY USE
26	MAINTENANCE
27	NOISE LEVEL
28	PROBLEMS AND SOLUTIONS
29	DEMOLITION AND DISPOSAL
30	EXPLODED VIEWS
31	OVERALL DIMENSIONS

2 MACHINE AND MANUFACTURER IDENTIFICATION

CODE PRODUCT		YEAR OF MANUFACTURE
MODEL	PIUSI S.p.A. Via Pacinotti 16/A - Z.I. Rangovino 46029 Suzzara (MN) Italy	
TECHNICAL DATA	12V 24V DC DC 100W 15A max. 270V ON/OFF IP55 EN 60034-5	

AVAILABLE MODELS	12-24V DC
MANUFACTURER	PIUSI S.p.A. Via Pacinotti 16/A - Z.I. Rangovino 46029 Suzzara (MN) Italy

3 DECLARATION OF CONFORMITY

The undersigned: PIUSI S.p.A.
Via Pacinotti 16/A - z.i. Rangovino
46029 Suzzara - (MN) - Italy

Hereby states under its own responsibility, that the equipment described below:

Description: Dispenser Pump for the transfer of Ad-Blue® - AUS32 - WATER - Antifreeze Model: **Diaphragm pump**
Serial number: refer to Lot Number shown on CE plate affixed to product
Year of manufacture: refer to the year of production shown on the CE plate affixed to the product is in conformity with the legal provisions indicated in the directives:

- **Machine Directive 2006/42/EC**
- **Electromagnetic Compatibility Directive 2014/30/EU**
The documentation is at the disposal of the competent authority following motivated request at Piusi S.p.A. or following request sent to the e-mail address: doc.tec@piusi.com The person authorised to compile the technical file and draw up the declaration is Otto Varini as legal representative

Suzzara, 20/04/2016

Otto Varini
legal representative

4 MACHINE DESCRIPTION



PUMP MOTOR
Five-chamber positive-displacement diaphragm pump. Brush motor, DC, low tension with intermittent cycle, closed type in protection class IP55 according to CEI-EN 60034-5, directly f anged to the pump body.

4.1 HANDLING AND TRANSPORT

Foreword
Due to the limited weight and dimensions of the pumps, special lifting equipment is not required to handle them. The pumps are carefully packed before dispatch. Check the packing when receiving the material and store in a dry place.

STORAGE
- Store in a covered and dry place.
- Store the unit away from dirt and vibration
ENVIRONMENTAL CONDITIONS:
Storage humidity: Max 90%
Storage temperature: min -10 °C / Max +50 °C

PACKAGING
The pump is equipped comes packed suitably for shipment. On the packaging a label shows the following product information:

- name	
- code	
- weight	

MODEL	WEIGHT (Kg)	PACKAGING DIMENSION (mm)
Versione 12V	3,6	350 x 180 x 280
Versione 24V	3,6	350 x 180 x 280

5 GENERAL WARNINGS

Warnings
To ensure operator safety and to protect the dispensing system from potential damage, workers must be fully acquainted with this instruction manual before attempting to operate the dispensing system.

The following symbols will be used throughout the manual to highlight safety information and precautions of particular importance:

ATTENTION
 This symbol indicates safe working practices for operators and/or potentially exposed persons.

WARNING
 This symbol indicates that there is risk of damage to the equipment and/or its components.

NOTE
 This symbol indicates useful information.

Manual preservation
This manual should be complete and legible throughout. It should remain available to end users and specialist installation and maintenance technicians for consultation at any time.

Reproduction rights
All reproduction rights are reserved by Piusi S.p.A. The text cannot be reprinted without the written permission of Piusi S.p.A.

© Piusi S.p.A.
THIS MANUAL IS THE PROPERTY OF Piusi S.p.A.
ANY REPRODUCTION, EVEN PARTIAL, IS FORBIDDEN.

This manual belongs to Piusi S.p.A., which is the sole proprietor of all rights indicated by applicable laws, including, by way of example, laws on copyrights. All the rights deriving from such laws are reserved to Piusi S.p.A.; the reproduction, including partial, of this manual, its publication, change, transcription and notification to the public, transmission, including using remote communication media, placing at disposal of the public, distribution, marketing in any form, translation and/or processing, loan and any other activity reserved by the law to Piusi S.p.A..

6 SAFETY INSTRUCTIONS

ATTENTION
 You must avoid any contact between the electrical power supply and the fluid that needs to be FILTERED.

Maintenance control
 Before any checks or maintenance work are carried out, disconnect the power source.

FIRE AND EXPLOSION
 Use equipment only in well ventilated area.

When flammable fluids are present in the work area, such as gasoline and windshield wiper fluid, be aware that flammable fumes can ignite or explode. To help prevent fire and explosion:
 Keep work area free of debris, including rags and spilled or open containers of solvent and gasoline.

Do not plug or unplug power cords or turn lights on or off when flammable fumes are present.

Ground all equipment in the work area.

Stop operation immediately if static sparking occurs or if you feel a shock. Do not use equipment until you identify and correct the problem.

Keep a working fire extinguisher in the work area.

Electrocution or death
 This equipment must be grounded. Improper grounding, setup or usage of the system can cause electric shock.

Turn off and disconnect power cord before servicing equipment. Connect only to a grounded electrical outlets.

Use only 3 wire extension cords in accordance with local electrical codes. Extension cords should have a ground lead.

Ensure ground prongs are intact on power and extension cords. Do not expose to rain. Store indoors.

Never touch the electric plug of socket with wet hands. Do not turn the dispensing system on if the power connection cord or other important parts of the apparatus are damaged, such as the inlet outlet plumbing, dispensing nozzle or safety devices. Replace damaged components before operation.

Before each use check that the power connection cord and power plug are not damaged. If damaged, have power connection cord replaced before use by a qualified electrician.

The electrical connection between the plug and socket must be kept well away from water.

Unsuitable extension leads can be hazardous, in accordance with current regulations, only extension cords that are labelled for outdoor use and have a sufficient conduction path should be used outdoors.

For safety reasons, we recommend that, in principle, the equipment be used only with a earth-leakage circuit breaker (max 30 mA).

Electrical connections must use ground fault circuit interrupter (GFCI).

Installation operations are carried out with the box open and accessible electrical contacts. All these operations have to be done with the unit isolated from the power supply to prevent electrical shock!

Do not operate the unit when fatigued or under the influence of drugs or alcohol.

Do not leave the work area while equipment is energized or under pressure.

Turn off all equipment when equipment is not in use. Do not alter or modify equipment. Alterations or modifications may void agency approvals and create safety hazards.

Route hoses and cables away from traffic areas, sharp edges, moving parts, and hot surfaces.

Do not kink or over bend hoses or use hoses to pull equipment. Keep children and animals away from work area.

Comply with all applicable safety regulations.

To avoid severe burns do not touch hot fluid or equipment.

Burn Hazard
 Equipment surfaces and fluid that is heated can become very hot during operation.

Toxic Fluid or Fumes Hazard
 Read MSDSs to know the specific hazards of the fluids you are using. Store hazardous fluid in approved containers, and dispose of it according to applicable guidelines.

Prolonged contact with the treated product may cause skin irritation: always wear protective gloves during dispensing.

7 FIRST AID RULES

Contact with the product
In the event of problems developing following EYE/SKIN CONTACT, INHALATION or INGESTION of the treated product, please refer to the SAFETY DATA SHEET AUS32/DEF-Ad-Blue®/Antifreeze.

Disconnect the power source, or use a dry insulator to protect yourself while you move the injured person away from any electrical conductor. Avoid touching the injured person with your bare hands until he is far away from any conductor. Immediately call for help from qualified and trained personnel. Do not operate switches with wet hands.

Persons who suffered electric shock

NOTE
 Please refer to the safety data sheet for the product

ATTENTION
 Essential protective equipment characteristics

Wear protective equipment that is:

- suited to the operations that need to be performed;
- resistant to cleaning products.

 safety shoes;

 close-fitting clothing;

 protection gloves;

 safety goggles;

Other equipment
 instructions manual

Protective gloves
 Prolonged contact with the treated product may cause skin irritation: always wear protective gloves during dispensing.

9 TECHNICAL DATA

9.1 PERFORMANCE SPECIFICATIONS

The performance diagram shows flow rate as a function of back pressure.

Functioning Point	Flow Rate	Voltage (V)	Absorption (A)	Typical Delivery Configuration		
				No. 4 metres of 3/4" pipe	K/2 Meter	Manual nozzle
A (Maximum flow rate)	36	12	16	•	•	
B	33	12	17	•	•	
C (High flow rate)	30	12	19	•	•	
D (Normal conditions)	24	24	20	•	•	
E (By pass)	0	24	20	Delivery closed		

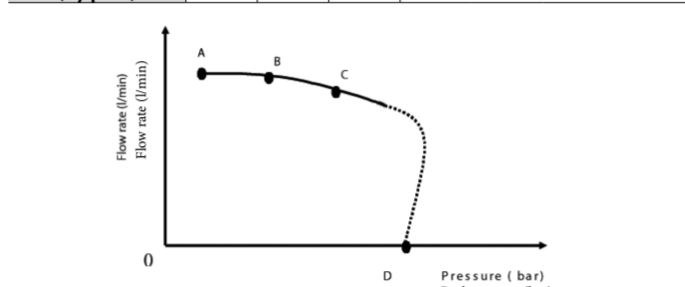

ATTENTION
 The curve refers to the following operating conditions:

Fluid: AUS32 - DEF - Ad-Blue® - Antifreeze

Temperature: 20° C

Suction conditions: The pipe and the pump position relative to the fluid level is such that a low pressure of 0.3 bar is generated at the nominal flow rate.

Under different suction conditions higher low pressure values can be created that reduce the flow rate compared to the same back pressure values. To obtain the best performance, it is very important to reduce loss of suction pressure, as much as possible by following these instructions:

- shorten the suction pipe as much as possible
- avoid useless elbows or throttling in the pipes
- keep the suction filter clean

Use a pipe with a diameter equal to, or greater than, indicated (see Installation).

10 ELECTRICAL DATA

PUMP MODEL	POWER SUPPLY	CURRENT	Voltage (V)	Frequency (Hz)	CURRENT Max (*) (A)
12V version	DC	12	20	20	20
24V version	DC	24	10	10	10

(*) Refers to functioning in by-pass mode.

11 OPERATING CONDITIONS

11.1 ENVIRONMENTAL CONDITIONS

TEMPERATURE
min. +25 °F / max. +104 °F
min. -5 °C / max. +40 °C
max. 90%

RELATIVE HUMIDITY
ATTENTION
 The temperature limits shown apply to the pump components and must be respected to avoid possible damage or malfunction.

11.2 ELECTRICAL POWER SUPPLY

NOTE
 N.B.: THE PUMP SHOULD BE POWERED BY A SAFE SOURCE: BATTERY OR POWER SUPPLY 12/24V WITH SAFETY TRANSFORMER.

In accordance with the model, the pump must be powered by a direct current line, the nominal values of which are indicated on the table in the paragraph "ELECTRICAL DATA".

The maximum acceptable variations from the electrical parameters are:

Voltage: +/- 10% of the nominal value.

Power supply from lines with values that do not fall within the indicate limits could cause damage to the electrical components and reduction of working performance.

11.3 DUTY CYCLE

NOTE
 The pumps have been designed for intermittent use and a 20-minute duty cycle under conditions of maximum back pressure.

ATTENTION
 Functioning under by-pass conditions is only allowed for short periods of time (max. 3 minutes).

11.4 PERMITTED AND NON-PERMITTED FLUIDS

FLUIDS PERMITTED

- AUS32 (DEF, AD-Blue®);
- WATER
- ANTIFREEZE

FLUIDS NON-PERMITTED AND RELATED DANGERS

- DIESEL FUEL - OXIDATION OF PUMP
- PETROL - FIRE
- INFLAMMABLE LIQUIDS - EXPLOSION
- CORROSIVE CHEMICAL PRODUCTS - CORROSION AND INJURY TO PERSONS
- SOLVENTS - DAMAGE TO GASKET SEALS

- LIQUIDS WITH VISCOSITY >20 cst
- MOTOR OVERLOAD

12 INSTALLATION

ATTENTION
 The pump must never be operated before the delivery and suction lines have been connected.

PRELIMINARY INSPECTION
 Verify that all components are present. Request any missing parts from the manufacturer.

- Check that the pump has not suffered any damage during transport or storage.

- Carefully clean the suction and delivery inlets and outlets, removing any dust or other packaging material that may be present.

- Check that the electrical data corresponds to those indicated on the data plate.

- Always install in an illuminated area.
- Install the pump at a height of min. 80 cm.

12.1 POSITIONING, CONFIGURATIONS AND ACCESSORIES

NOTE
 In the case of installation in the open air, proceed to protect the pump by providing a protection roof.

The pump can be installed in any position (pump axis vertical or horizontal).

The pump must be secured in a stable way using the holes on the bed of the motor and vibration damping devices.

ATTENTION
 THE MOTORS ARE NOT OF THE ANTI-EXPLOSIVE TYPE. DO NOT install them where inflammable vapours could be present.

NOTE
 The broad range of pump accessories make it suitable for many different uses, installations and applications. The supporting base can be positioned in different ways.

ATTENTION
 It is the responsibility of the installer to provide the necessary line accessories to ensure the correct and safe operation of the pump. The accessories that are not suitable to be used with the previously indicated material could damage the pump and/or cause injury to persons, as well as causing pollution.

NOTE
 To maximise performance and prevent damage that could affect pump operation, always demand original accessories.

ATTENTION
 To maximise performance and prevent damage that could affect pump operation, always demand original accessories.

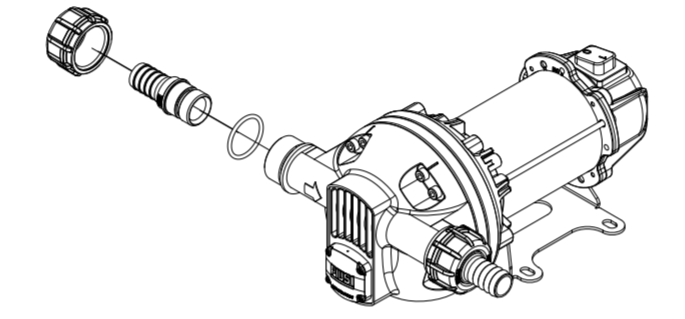

12.2 NOTES ON SUCTION AND DELIVERY LINES

DELIVERY EFFECTS ON FLOW RATE
Length and diameter of pipe, flow rate of dispensed liquid, accessories fitted, can create back pressures above those allowed. In this case, the pump mechanical control (bypass) will trip to reduce the flow rate.

HOW TO REDUCE EFFECTS ON FLOW RATE
To avoid these problems, system flow resistances must be reduced using shorter and/or larger diameter pipes, as well as line accessories with low resistances (e.g. automatic nozzle for higher flow rates).

CHARACTERISTICS OF DELIVERY PIPES
 The delivery pipe must have the following technical characteristics:

- recommended minimum nominal diameter: 3/4"

- recommended nominal pressure: 10 bar

SUCTION FOREWORD
Diaphragm positive-displacement pumps are self-priming and feature good suction capacity.

During the start-up phase, when the suction pipe is empty and the pump is wet, the electric pump unit is able to suck liquid from a maximum vertical distance of 2 mt.

IMPORTANT NOTE
 Priming time can last a few minutes. We suggest performing priming operations without automatic nozzle and making sure the pump is properly wet.

WARNING
 Always install a foot valve to prevent the suction pipe from being emptied and to keep the pump wet at all times. In this way, the pump will always start up immediately the next times it is used.

CAVITATION
The pump is able to work with vacuums of up to 0.5 bar at the suction mouth. Over this value, CAVITATION can occur that causes a fall in flow rate and increase in noise levels.

It is important to ensure low vacuums at suction mouth by using: short pipes with larger or identical diameter to that recommended;

- reduce bends to the utmost

- use large-section suction filters

- use foot valves with minimum possible resistance

- keep the suction filters clean because, when they become clogged, they increase the resistance of the system.

WARNING
 The vertical distance between the pump and the fluid must fall within the 2 mt. maximum required for priming. If the distance is greater, a foot valve must be installed to allow the suction pipes to fill up and the diameter pipes must be larger. It is recommended that the pump not be installed at a vertical distance greater than 2 meters.

ATTENTION
 If the suction tank is higher than the pump, an anti-siphon valve should be installed to prevent accidental product leaks. Size the installation to contain the back pressures caused by water hammering.

ATTENTION
 It is a good system practice to immediately install vacuum and air pressure gauges at the inlets and outlets of the pump which allow verification that operating conditions are within anticipated limits.

To prevent the suction pipes from being emptied when the pump stops, a foot valve should be installed.

The suction pipe must have the following technical specifications:

- recommended minimum nominal diameter: 3/4";

- recommended nominal pressure: 10 bar;

- use pipes suitable for low pressure operation (e.g. with metal core)

13 CONNECTIONS

13.1 ELECTRICAL CONNECTIONS

GENERAL WARNING

