

T316L Multi-Position Butterfly Valve

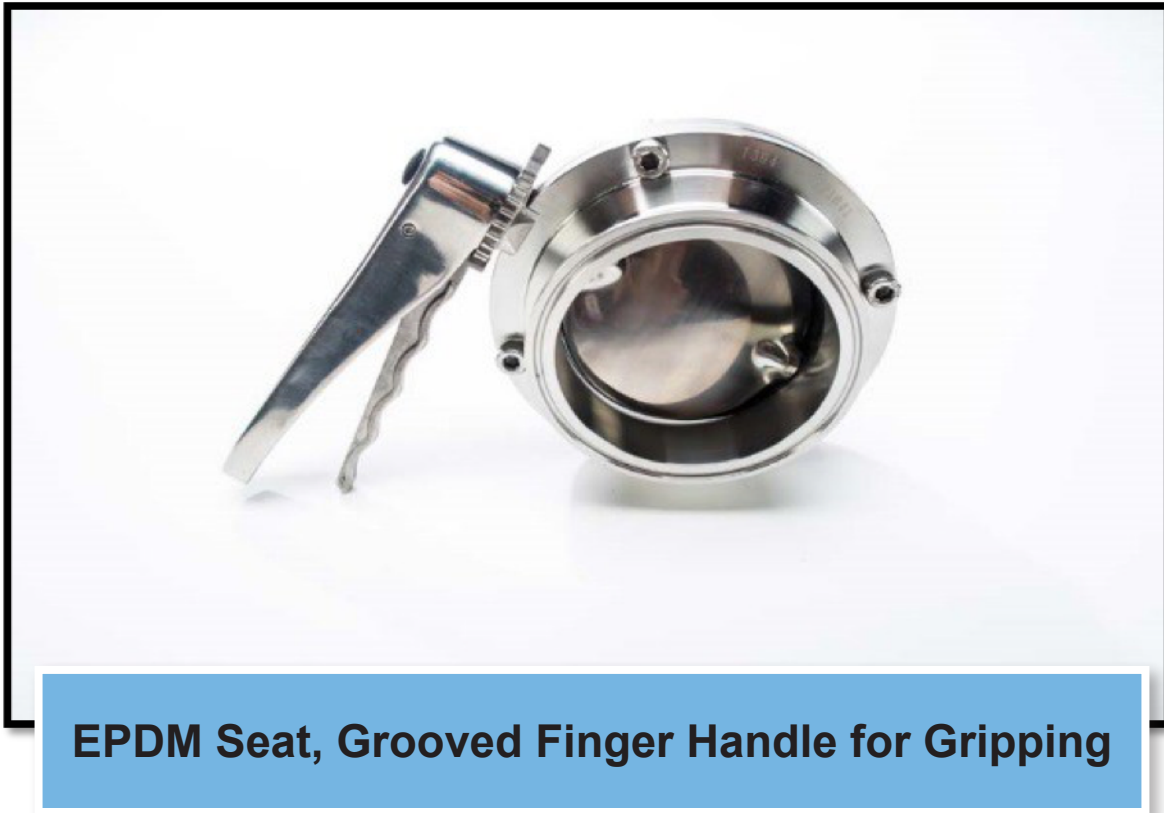

Features of the Multi-Position Clamp Butterfly Valve:

T316L

Polish to 32Ra

Heat Number

100% Hydraulic Pressure Test

Interchangeable Handle to either side

Operating Temperature: 15°F to 195°F

Field Serviceable

Other Seats: Silicone or Viton®

Repair Kits: Seat & Bushings (in stock)

www.sanitarysolutions.com

Sanitary Solutions Inc. 1-888-909-3569 or 1-855-640-7871

Prices are subject to change without notice; please call before you quote

T316L Multi-Position Clamp Butterfly Valve Dimensions

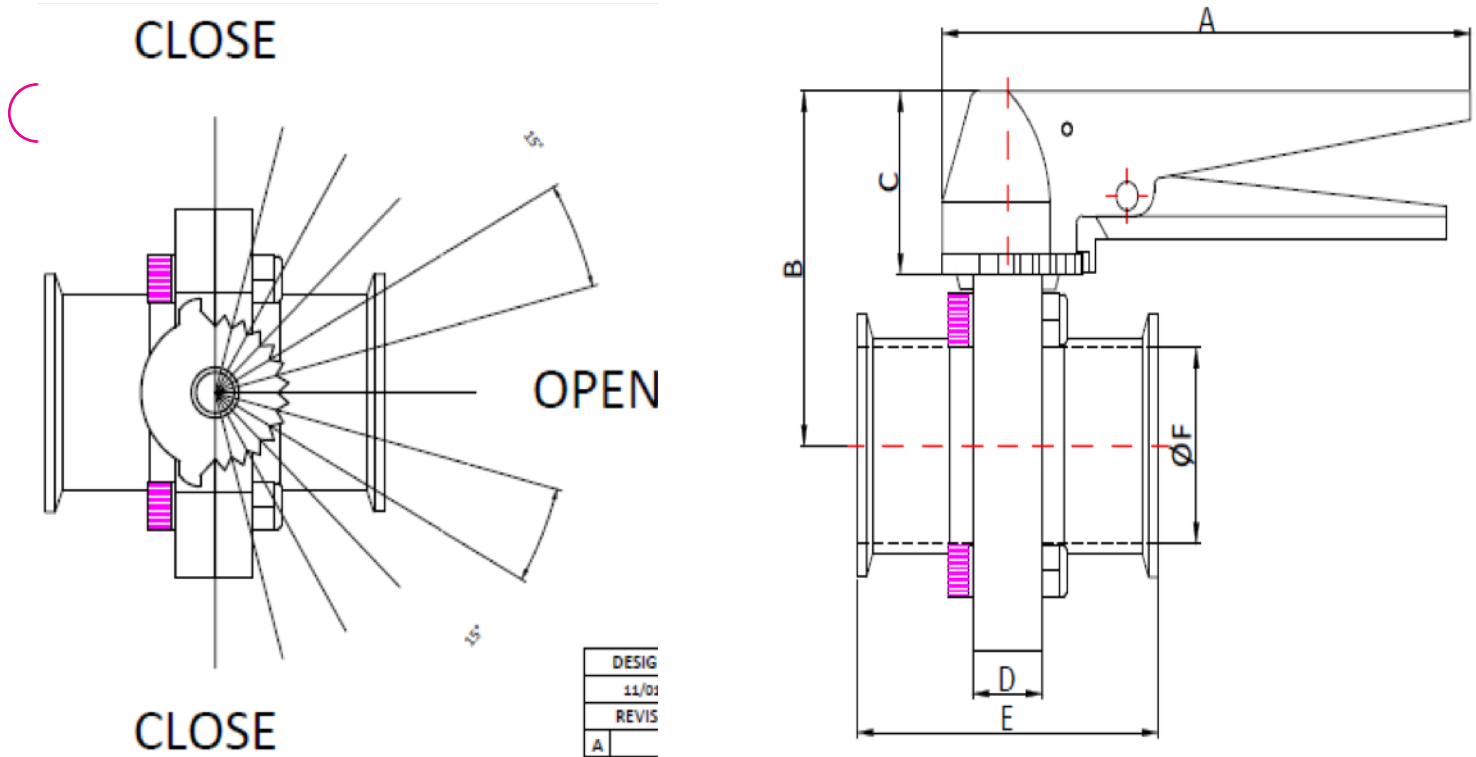

Size	A	B	C	D	E	F	Torque In lbs.	PSI	Weight
1"	6.649	3.016	1.724	0.866	3.512	0.874	75	140	3.90
1.5"	6.649	3.016	1.724	0.866	3.512	1.370	130	140	3.20
2"	6.649	3.358	1.724	0.866	3.780	1.870	165	140	4.30
2.5"	6.649	3.732	1.724	0.866	3.827	2.370	210	110	6.30
3"	6.649	3.969	1.724	0.866	4.050	2.866	350	110	6.70
4"	6.649	4.766	1.724	1.181	4.819	3.830	540	85	10.80

T316L Multi-Position Butterfly Valve Part Number Example:

SSBFV-SIZE-316L

www.sanitarysolutions.com

Sanitary Solutions Inc. 1-888-909-3569 or 1-855-640-7871

Prices are subject to change without notice; please call before you quote

T316L Multi-Position Butterfly Material List

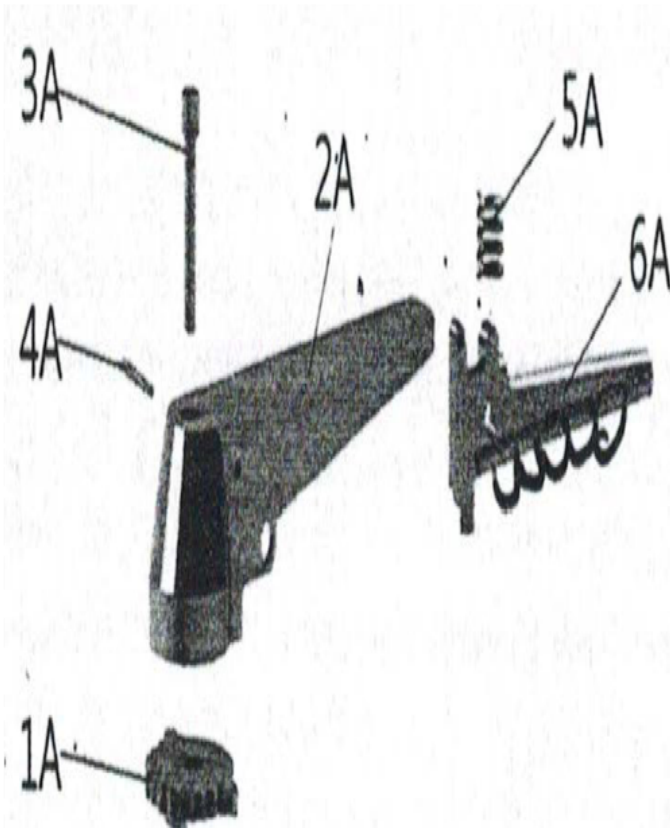

Item	Discription	Material	Quantity
Trigger Handle			
1A	sprocket	CF8	1
2A	handle	CF8	1
3A	hex socket bolt	304	1
4A	pin	304	1
5A	spring	304	1
6A	trigger	CF8	1

Valve			
1	body	316L	2
2	disc	316L	1
3	seat	silicone	1
		EPDM	
		FKM	
4	bushing	polyacetal	2
5	hex nut	304	4
6	bolt	304	4
6W	optional wing nut	304	4

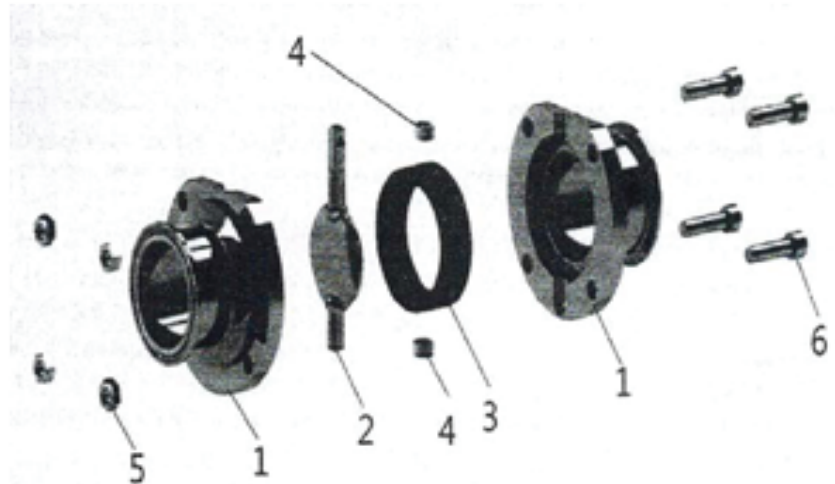

www.sanitarsolutions.com

Sanitary Solutions Inc. 1-888-909-3569 or 1-855-640-7871

Prices are subject to change without notice; please call before you quote